

# playtech



# playtech



# Soluciones

Solutions/Des solutions/Soluções

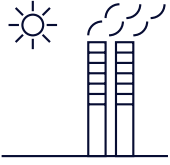

Cora Industry Lite 34

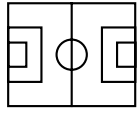

Cora Sports 42

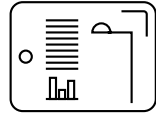

UNIO 54

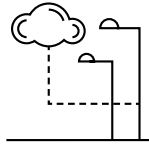

Cora Manager 58

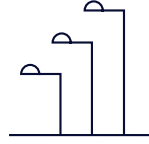

Multipotencia 64

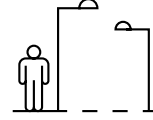

Safelight 68

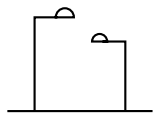

WAS outdoor 72



WAS indoor 78

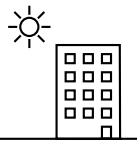

Pack CTE 82

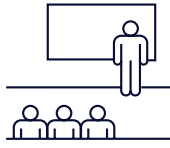

Pack Aula/ Despachos 86

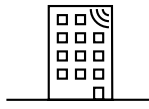

Versión BLUETOOTH 90

# City



Arisa Road 104



Arisa Catenaria 106



Arisa Top1 108



Arisa Top2 110



Arisa Top4 112



Versa 114



Versa L 116



Versa XL 118



Avatar 120



Avatar L 122



Avatar XL 124



Veria 126



Sfera 128



Netta 130



Livia 132



Ircana 134



Gaudium 136



Grupo Óptico Universal 140



Zereus Switch 142



Accesorios 144



# Industrial



Hexagon Zenit 48 Leds 166



Hexagon Zenit 144 Leds 168



Berlín Avant 170



Benzine Élite Empotrar 172



Benzine Élite Superficie 174



Accesorios 176

# Projection

**N**  
NEW



Hexagon Play Essential 198



Hexagon Play Optima 200



Hexagon Play WAS 202



Hexagon Play Match Unity 204



Hexagon Play Match 212



Hexagon Play Arena 214

**N**  
NEW



Nantes Play 220

**N**  
NEW



Nantes Play L 222

**N**  
NEW



Nantes Play XL 224



Accesorios 226

# Spaces



Lynx Led Superficie 244



Lynx Led Line Superficie 246



Lynx Led Empotrar 248



Lynx Led Line Empotrar 250



Lynx Led Pared 252

**N**  
NEW



Stania 258



Silent Led V IP65 260

# Spaces



Kobe 262



Kobe Switch 264



Tribola 266



Ebro Led 268



Miño Led 270



Voltore I 272



Voltore II 274



Accesorios 276

# Arquitectural



Hexagon Play RGBW 296



Hexagon Play RGBW Remoto 297



Tanek ARQ 300



Tanek ARQ RGBW 302



Led Pad Avant 304



Led Pad Avant RGBW 306



Accesorios 308

# Fotometría

Photometry/ Photométrie/ Fotometria

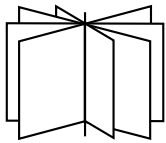

Curva de distribución 326

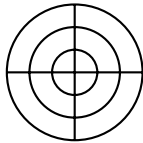

Fotometría 328

# Anexos

Annexes/ Annexes/ Anexos

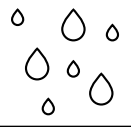

Grado de protección 348

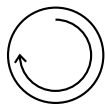

Regulación 350

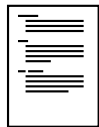

Glosario 352

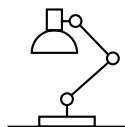

Iluminancias medias 356

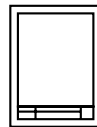

Proyectos 359

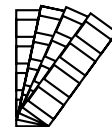

Carta RAL 360

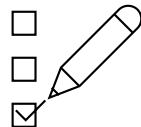

Certificaciones 362

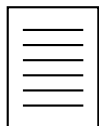

Condiciones de Uso 362



Condiciones de Garantía 362

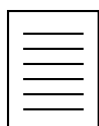

Condiciones de Venta 362



Simbología 364



# PRILUX

Prilux es una empresa con más de 35 años de experiencia en el sector de la iluminación. Focalizada en I+D+i, ayudamos a las empresas, instituciones y propiedad final a iluminar sus espacios a través de productos y soluciones tecnológicas fiables, innovadoras, personalizadas, escalables y de alto valor añadido.

Nuestro objetivo es ofrecer al sector soluciones de iluminación inteligente en todas las áreas mediante el uso de sistemas de control y regulación. Por esta razón desarrollamos tecnología propia que permite una gestión óptima del consumo, mejorar el confort y generar un importante ahorro económico de forma sostenible.

Personalización, flexibilidad, eficiencia y sostenibilidad son los valores que nos mueven a diseñar y fabricar luminarias y tecnología para nuestros clientes.

Somos una ingeniería de valor en proyectos de alumbrado público, industrial, deportivo, arquitectural y festivo/navideño.

Prilux is a company with over 35 years' experience in the lighting sector. Focusing on R&D&i, we help companies, institutions and final owners light their spaces using reliable, innovative, customised, scalable technological products and solutions with high added value.

Our aim is to provide the sector with smart lighting solutions in all areas, making use of control and regulating systems. We develop our own technology for this reason, to enable optimal management of consumption, improve comfort and generate significant economic savings sustainably.

Customisation, flexibility, efficiency, and sustainability are values that drive us in designing and manufacturing luminaires and technology for our customers.

We are a value engineering company in public, industrial, sporting, architectural and festive/ Christmas lighting projects.





Prilux est une entreprise qui jouit de plus de 35 ans d'expérience dans le secteur de l'éclairage. Axée sur la R+D+i, nous aidons les entreprises, les institutions et les propriétaires finaux à éclairer leurs espaces grâce à des produits et des solutions technologiques fiables, innovatrices, personnalisées, évolutives et à forte valeur ajoutée.

Notre objectif : proposer au secteur des solutions d'éclairage intelligent dans tous les domaines à l'aide de systèmes de contrôle et de régulation. C'est pour cette raison que nous développons notre propre technologie de sorte à permettre une gestion optimale de la consommation, à améliorer le confort et à donner lieu à une importante économie d'énergie de manière durable.

Personnalisation, souplesse, efficacité et durabilité sont les valeurs qui nous encouragent à concevoir et à fabriquer des luminaires et une technologie adaptés à nos clients.

Nous sommes une entreprise d'ingénierie de grande valeur, qui travaille sur des projets d'éclairage public, industriel, sportif, architectural et festif/de Noël.

A Prilux é uma empresa com mais de 35 anos de experiência no setor da iluminação. Focada em I+D+i, ajudamos as empresas, instituições e proprietários finais a iluminar os seus espaços através de produtos e soluções tecnológicas fiáveis, inovadoras, personalizadas, escaláveis e de elevado valor acrescentado.

O nosso objetivo é oferecer ao setor soluções de iluminação inteligente em todas as áreas, recorrendo à utilização de sistemas de controlo e regulação. Por este motivo desenvolvemos tecnologia própria que permite uma gestão otimizada do consumo, melhorar o conforto e gerar uma significativa poupança económica de forma sustentável.

Personalização, flexibilidade, eficiência e sustentabilidade são os valores que nos motivam a conceber e fabricar luminárias e tecnologia para os nossos clientes.

Somos uma empresa de engenharia de valor em projetos de iluminação pública, industrial, desportiva, arquitetural e festiva/natalícia.

# Infraestructuras

Infrastructures

Infraestructuras

Infraestructuras

## Toledo

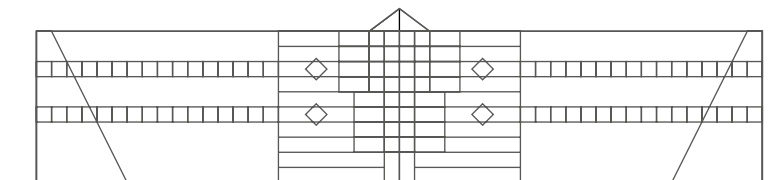

**16.500m<sup>2</sup>**

Almacén y centro productivo  
Warehouse & Production centre  
Stockage et centre de production  
Armazém e centro produtivo



**200m<sup>2</sup>**

Laboratorio  
Laboratories  
Laboratoires  
Laboratório



**300m<sup>2</sup>**

Salas limpias  
Clean rooms  
Salles blanches  
Salas limpas



**3.000m<sup>2</sup>**

Showrooms  
Showrooms  
Showrooms  
Showrooms

Con sede central en Toledo y delegación en Sant Llorenç d'Hortons (Barcelona), Prilux cuenta con modernas y amplias instalaciones que albergan espacios de oficina, conferencias, showrooms de exposición, laboratorio, almacenamiento, producción y salas limpias.

Además, nuestra delegación noreste actúa como plataforma logística para dar soporte al mercado internacional en Europa.

With its headquarters in Toledo and branch in Sant Llorenç d'Hortons (Barcelona), Prilux has modern and extensive infrastructure housing storage, work and exhibition spaces such as: warehouses, production centres, laboratories, clean rooms, showrooms, training rooms and offices.

Also our northeast branch serves as a logistics platform for our expansion across Europe.

# Sant Llorenç d'Hortons (Barcelona)

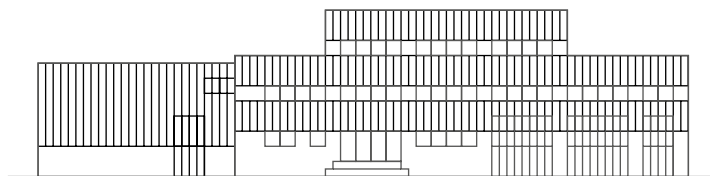

**13.000m<sup>2</sup>**

Almacén y centro productivo  
Warehouse & Production centre  
Stockage et centre de production  
Armazém e centro produtivo



**13**

Muelles de carga  
Loading bays  
Quais de chargement  
Cais de carga



**2.000m<sup>2</sup>**

Oficinas  
Offices  
Bureaux  
Escritórios



**2**

Showrooms  
Showrooms  
Showrooms  
Showrooms

Le siège central de Prilux se trouve à Tolède et une antenne à Sant Llorenç d'Hortons (Barcelona), Prilux dispose d'infrastructures qui hébergent des espaces de stockage, de travail et d'exposition : entrepôts, centres de production, laboratoires, salles blanches, showrooms, salles de formation et bureaux.

De plus, notre délégation du Nord-est est une plate-forme logistique pour notre expansion en Europe.

Com a sede central situada em Toledo e delegação em Sant Llorenç d'Hortons (Barcelona), Prilux dispõe de infraestruturas que compreendem espaços de armazenamento, trabalho e exposição como: armazéns, centros de produção, laboratórios, salas limpas, showrooms, salas de formação e escritórios.

Além disso, nossa delegação do noreste funciona como plataforma logística para a nossa expansão na Europa.

# Prilux around the world



Tras 25 años centrados en el mercado español, exportamos principalmente a Europa, Europa del Este, Norte de África, Oriente Medio y América del Sur.

After 25 years focusing on the Spanish market, we export mainly to Europe, Eastern Europe, North Africa, the Middle East, South and America.



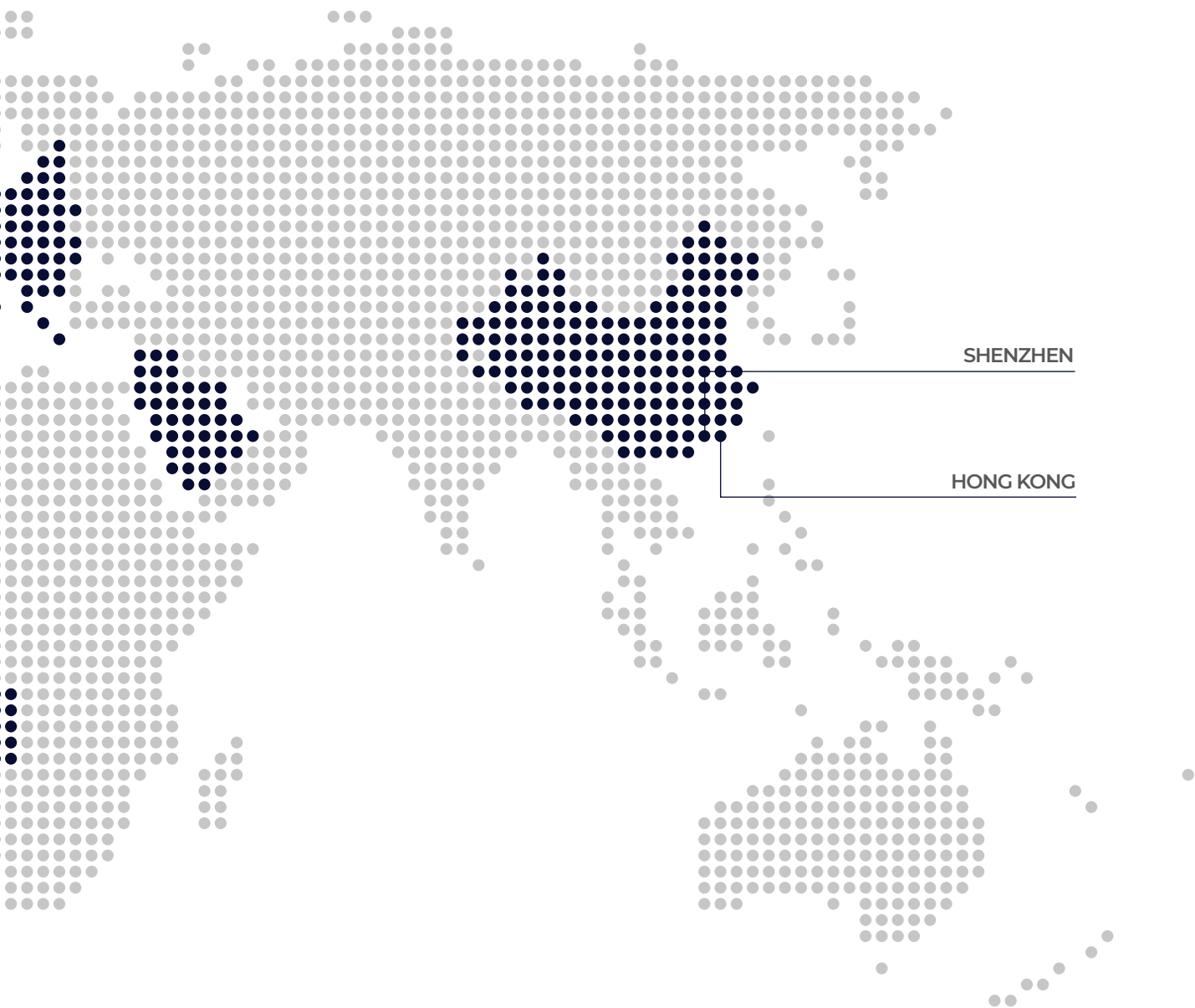

Après 25 ans centrés sur le marché espagnol, nous exportons principalement vers l'Europe, l'Europe de l'Est, l'Afrique du Nord, le Moyen Orient et l'Amérique du Sud

Após 25 anos concentrados no mercado espanhol, exportamos sobretudo para a Europa, Europa de Leste, Norte de África, Médio Oriente e América do Sul.

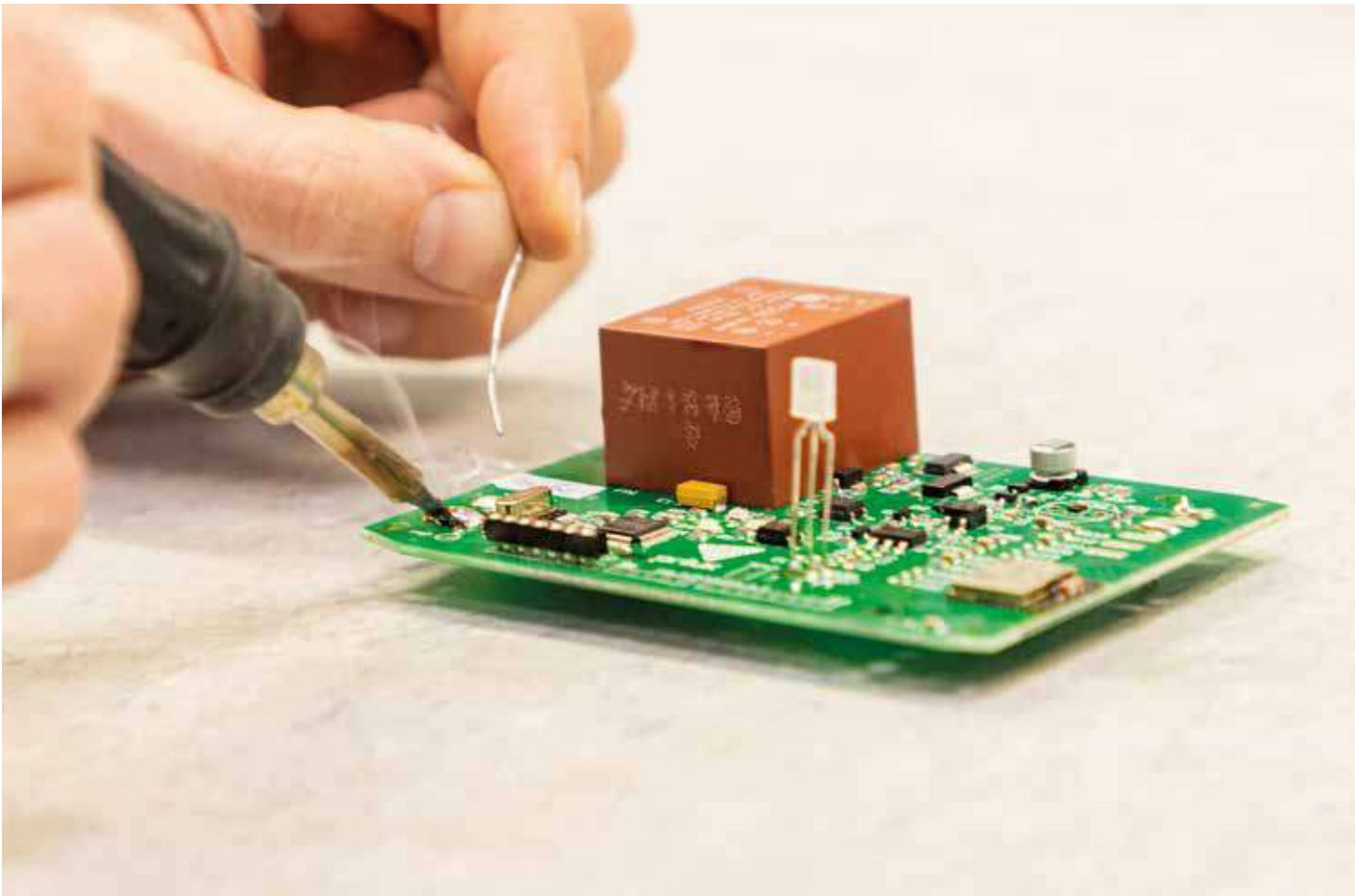

## I+D+i R&D&i

La innovación se ha convertido en una estrategia imprescindible para adaptarnos al mercado y su constante evolución. En Prilux apostamos por el futuro y nos apasiona diferenciar nuestros productos y soluciones explorando nuevos caminos a través de proyectos con varios horizontes temporales.

Trabajamos bajo softwares de última tecnología para mejorar la calidad de nuestros productos y adaptarnos a los cambios en el sector de forma ágil. Además, empleamos herramientas de simulación para predecir comportamientos y optimizar las soluciones.

Innovation is strategic and essential for Prilux in its commitment to the future. At Prilux we are committed to the future and are passionate about differentiating our products and solutions by exploring new avenues in projects with varying timescales.

We work using state-of-the-art software to improve the quality of our products and adapt swiftly to changes in the sector. We also use simulation tools to predict behaviour and optimise solutions.

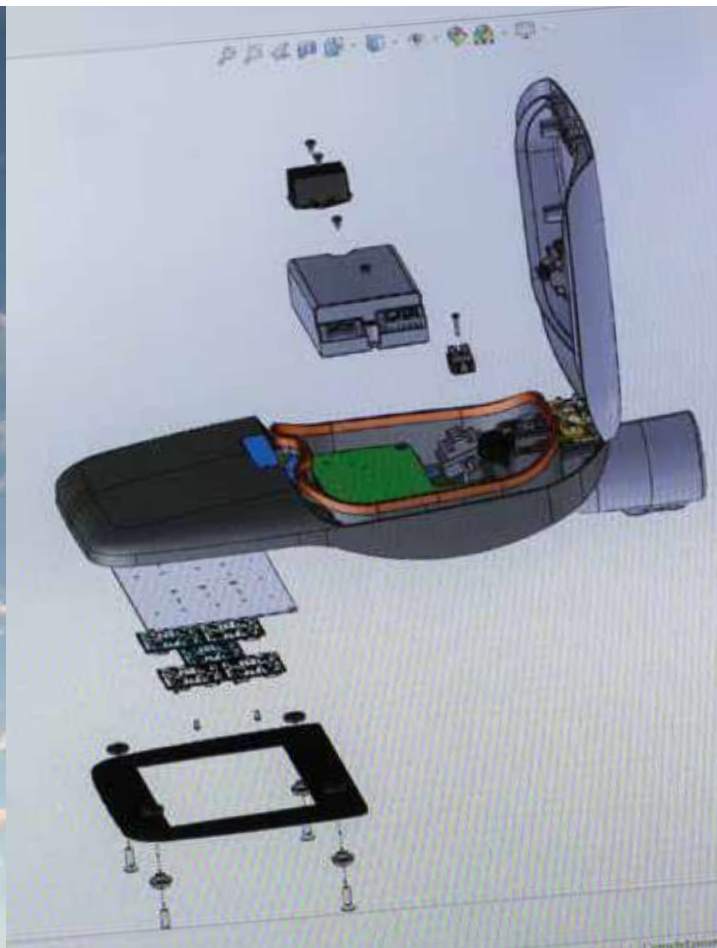

Pour Prilux, l'innovation est stratégique et indispensable pour tenir notre pari sur l'avenir. Prilux mise sur l'avenir et n'a de cesse de différencier produits et solutions, et d'explorer de nouvelles voies à travers des projets s'étendant sur divers horizons de temps.

Nous travaillons avec des logiciels de pointe pour améliorer la qualité de nos produits et nous adapter avec souplesse aux changements que vit le secteur. Nous utilisons également des outils de simulation pour prédire les comportements et optimiser les solutions.

A inovação para a Prilux é estratégica e indispensável ao apostar no futuro. Na Prilux apostamos no futuro e apaixonamos-nos diferenciar os nossos produtos e soluções explorando novos caminhos através de projetos com vários horizontes temporais.

Trabalhamos com softwares de última geração para melhorar a qualidade dos nossos produtos e nos adaptarmos às mudanças no setor de forma ágil. Além disso, utilizamos ferramentas de simulação para prever comportamentos e otimizar as soluções.

# Producción y Calidad

Production and quality

Fabrication et Qualité

Produção e Qualidade

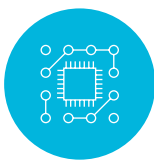

## Módulos LED propios

Own LED modules  
Modules LED propres  
Módulos LED próprios



## Control de calidad

Quality control  
Contrôle de qualité  
Controlo de qualidade



## Trazabilidad

Traceability  
Traçabilité  
Leitura



## Certificado ENEC (AENOR)

ENEC certification (AENOR)  
certificat ENEC (AENOR)  
certificado ENEC (AENOR)

Contamos con una “sala Blanca” equipada con una línea automática de montaje de componentes SMD (Serigrafía – Pick & Place – Horno) donde fabricamos todos nuestros módulos LED destinados a las soluciones lumínicas “made in Spain”.

Prilux dispone de un departamento de Calidad especializado tanto en la Calidad de Producto, como en el control de la Calidad Total empresarial que emplea la herramienta CERTOOL de AENOR para la gestión de la calidad y mejora continua de nuestros procesos. Este seguimiento permite ofrecer un servicio que cumpla con las especificaciones atribuidas en su totalidad.

Contamos con familias de productos con certificado ENEC, concedido por AENOR, que garantiza la calidad y seguridad de los productos, tanto en todo el proceso de fabricación, como cuando se introducen en el mercado.

We have a “clean room” equipped with an automatic SMD component assembly line (Screen Printing – Pick & Place – Oven) where we manufacture all our LED modules for “made in Spain” lighting solutions.

Prilux has a Quality department specialising both in Product Quality and in corporate Total Quality control which uses AENOR’s CERTOOL tool for quality management and continuous improvement of our processes. This monitoring means it can offer a service that meets all attributed specifications in full.

We have product families with ENEC certification, granted by the Spanish standards organisation AENOR, guaranteeing product quality and safety, both throughout the manufacturing process and when they are placed on the market.





Nous disposons d'une « salle blanche » équipée d'une ligne automatique de montage de composants SMD (sérigraphie - pick & place - four) où nous fabriquons tous nos modules LED destinés aux solutions d'éclairage « made in Spain ».

Prilux dispose d'un service qualité spécialisé aussi bien dans la qualité produit que dans le contrôle de la qualité intégrale de l'entreprise qui utilise l'outil AENOR CERTOOL pour la gestion de la qualité et l'amélioration continue de nos processus. Ce suivi permet de proposer un service répondant totalement aux spécifications attribuées.

Nous proposons des familles de produits certifiées ENEC, certification accordée par l'AENOR qui garantit la qualité et la sécurité des produits, aussi bien lors de l'ensemble du processus de fabrication que lors de leur mise sur le marché.

Dispomos de uma “sala branca” equipada com uma linha automática de montagem de componentes SMD (Serigrafia – Pick & Place – Forno) onde fabricamos todos os nossos módulos LED destinados às soluções lumínicas “made in Spain”.

A Prilux possui um Departamento de Qualidade especializado tanto na Qualidade do Produto, como no controlo da Qualidade Total empresarial que utiliza a ferramenta AENOR CERTOOL para gestão da qualidade e melhoria contínua dos nossos processos. Este seguimento permite oferecer um serviço que cumpra as especificações atribuídas na sua totalidade.

Dispomos de famílias de produtos com certificado ENEC, concedido pela AENOR, que garante a qualidade e segurança dos produtos, tanto em todo o processo de fabrico como quando são introduzidos no mercado.

# Laboratorio

Laboratory / Laboratoire / Laboratório



Personalización  
Personalization  
Personnalisation  
Personalização



Goniofotómetro  
Goniophotometer  
Goniophotomètre  
Goniofotómetro



Ensayos IP / IK  
IP / IK Tests  
Essais IP / IK  
Ensaaios IP / IK



Esfera integradora  
Integrating sphere  
Sphère d'intégration  
Esfera integradora

Prilux dispone de laboratorio propio equipado con capacidad material y competencia técnica para realizar los ensayos de precertificación de luminarias según UNE-EN 60598 y fuentes de luz.

realizamos la caracterización de seguridad: durabilidad, calentamiento, IP, IK, dieléctricos...; eléctrica; fotométrica bajo EN 13032; espectral según CIE S-025 y TM30-15, con evaluación del cumplimiento de las directivas de protección del cielo; flicker según nueva regulación de ecodiseño; parámetros de Human Centric Lighting (HCL) y medidas para horticultura.

Para cubrir las demandas más exigentes llevamos a nuestras luminarias a situaciones extremas en términos de regulación, rangos de funcionamiento, altas temperaturas, congelación, conmutaciones y forzado de protecciones que se dan en situaciones reales.

Acompañamos al cliente en su necesidad de justificar el cumplimiento de los requisitos demandados por áreas de negocio o mercados como los árabes, industria alimentaria, HCL en el ámbito de educación, sanidad, geriatría, etc.

Llevamos a cabo las tareas de certificación con laboratorios y entidades acreditadas externas para conseguir los certificados de producto ENEC, CB, N, IAC, y asegurar el cumplimiento de los requisitos del CEI-IDAE vigentes.

Prilux has its own laboratory equipped with the physical capability and technical competence to carry out pre-certification tests on luminaires under the UNE-EN 60598 standard and on light sources.

We perform characterisation of safety: endurance, thermal, ip, ik, dielectric...; electrical; photometric under EN 13032; spectral according to CIE S-025 and TM30-15, also evaluating compliance with directives on protection of the night sky; flicker according to new eco-design regulations; and human centric lighting (HCL) parameters and make measurements for horticulture.

To meet the most demanding requirements, we subject our luminaires to extreme conditions in terms of regulation, operating ranges, high temperatures, freezing, switching, and forcing of protections that occur in real situations. We work with our customers where they need to support compliance with requirements demanded by business sectors or markets, such as Arabian markets, the food industry, HCL in education, health care and geriatric fields, etc.

We conduct certification tasks with external laboratories and accredited entities to obtain ENEC, CB, N and Canary Islands Astrophysical Institute (IAC) product certificates and to ensure compliance with current Spanish Lighting Committee/Institute for Diversification and Saving of Energy (CEI-IDAE) requirements.



Prilux dispose de son propre laboratoire doté de la capacité matérielle et de la compétence technique nécessaires pour procéder aux tests de pré-certification de luminaires selon la norme UNE-EN 60598 et sources lumineuses.

Nous réalisons la caractérisation de sécurité: endurance, chauffage, ip, ik, diélectriques... ; électrique ; photométrique selon la norme EN 13032 ; spectrale selon la norme CIE S-025 et TM30-15, avec évaluation de la conformité aux directives de protection du ciel ; flicker selon la nouvelle réglementation sur l'écoconception ; paramètres de human centric lighting (HCL) et prise de mesures pour l'horticulture.

Pour répondre aux demandes les plus exigeantes, nous soumettons nos luminaires à des situations extrêmes en termes de réglementation, fourchettes de fonctionnement, hautes températures, congélation, commutations et forçage de protections, comme dans les situations réelles. Nous accompagnons le client dans ses besoins de justification du respect des exigences posées par les différents domaines d'activité ou marchés, comme le marché arabe, l'industrie alimentaire, le HCL dans le domaine de l'éducation, la santé, la gériatrie, etc.

Nous nous livrons à des travaux de certification avec des laboratoires et établissements agréés externes pour obtenir les certificats de produits ENEC, CB, N, IAC et garantir le respect des exigences CEI-IDAE en vigueur.

A Prilux dispõe de laboratório próprio equipado com capacidade material e competência técnica para realizar os ensaios de pré-certificação de luminárias segundo a UNE-EN 60598 e fontes de luz.

Realizamos a caracterização de segurança: resistência, aquecimento, ip, ik, dielétricos...; elétrica; fotométrica segundo a EN 13032; espectral segundo a CIE S-025 e TM30-15, com avaliação do cumprimento das diretivas de proteção do céu; flicker segundo a nova regulamentação de ecodesign; parâmetros de human centric lighting (HCL) e medidas para horticultura.

Para satisfazer as necessidades mais exigentes levamos as nossas luminárias a situações extremas em termos de regulação, faixas de funcionamento, altas temperaturas, congelamento, comutações e forçamento de proteções que ocorrem em situações reais. Acompanhamos o cliente na sua necessidade de comprovar o cumprimento dos requisitos exigidos por áreas de negócio ou mercados como os árabes, indústria alimentar, HCL no âmbito do ensino, saúde, geriatria, etc.

Realizamos as tarefas de certificação com laboratórios e entidades acreditadas externas para obter os certificados de produto ENEC, CB, N, IAC, e garantir o cumprimento dos requisitos do CEI-IDAE em vigor.



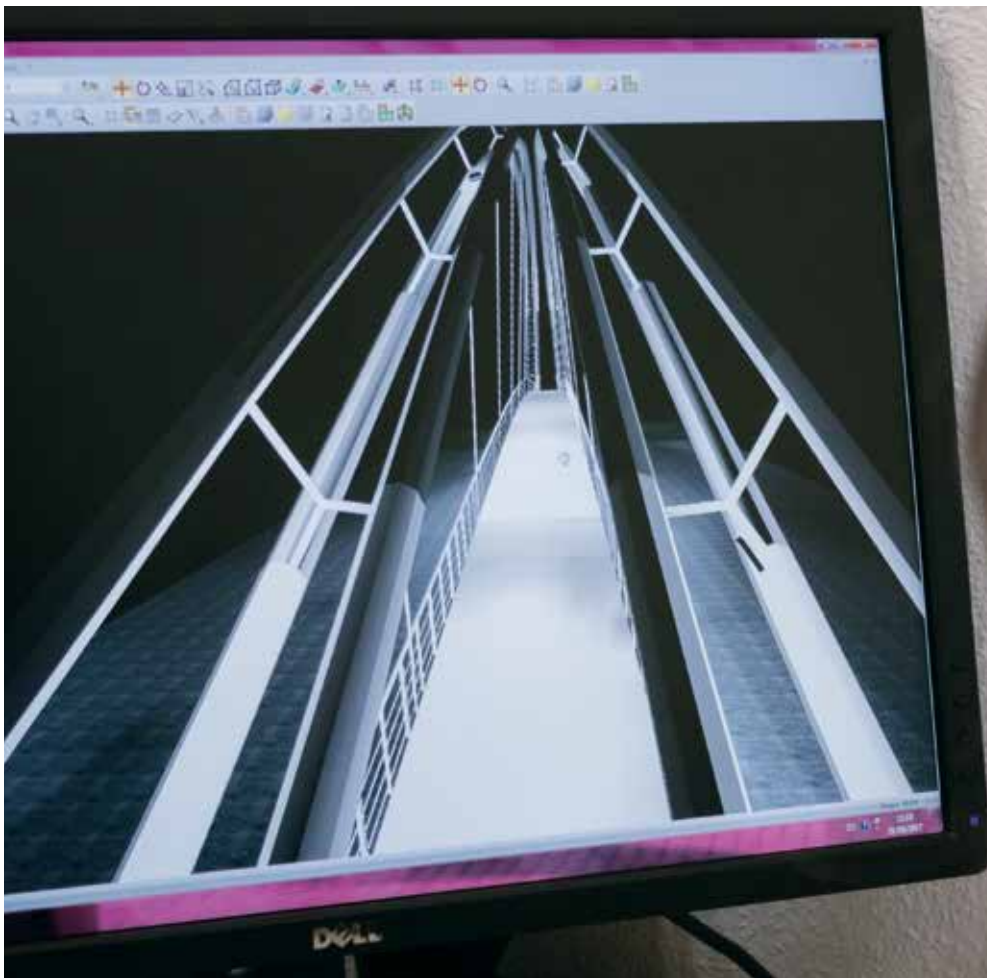

# Proyectos

## Projets / Projets / Projetos

Para las obras con mayores exigencias técnicas ponemos a disposición de nuestros clientes el departamento de proyectos, en el cual se estudian y diseñan soluciones lumínicas a través de software específico para ello.

Actualmente disponemos de soluciones tecnológicas de iluminación con sistemas de control integrados según demanda para la industria, oficinas, alumbrado público y vial, tiendas de retail, supermercados y centros comerciales, aplicaciones deportivas, parkings, hoteles, hospitales, colegios y universidades... Aportamos soluciones de iluminación creativas, personalizadas y adaptadas a las necesidades de nuestros clientes y ajustadas a la norma con un enfoque particular hacia el bienestar humano y la eficiencia energética.

For projects of major technical demand we provide our clients with access to the projects' department, which studies and designs lighting solutions by means of software specifically tailored for this purpose.

At present we provide on-demand lighting technological solutions with integrated control systems for industrial facilities, offices, public and street lighting, retail stores, supermarkets and shopping centres, sport facilities, car parks, hotels, hospitals, schools and universities... We offer creative, customised lighting solutions adapted to the needs of our clients and in compliance with regulations, with a particular focus on human welfare and energy efficiency.





Pour les travaux présentant des exigences techniques plus importantes, nous mettons à disposition de nos clients le département de projets, où les solutions d'éclairage sont étudiées et conçues grâce à un logiciel spécifique.

Nous disposons actuellement de solutions technologiques d'éclairage avec des systèmes de contrôle intégrés en fonction de la demande pour l'industrie, bureaux, l'éclairage public et routier, boutiques de vente au détail, supermarchés, centres commerciaux, applications sportives, parkings, hôtels, hôpitaux, écoles et universités... Nous fournissons des solutions d'éclairage créatives, personnalisées et adaptées aux besoins de nos clients, mais aussi conformes à la réglementation, avec une approche particulière focalisée sur le bien-être humain et l'efficacité énergétique.

Para as obras com maiores exigências técnicas colocámos à disposição dos nossos clientes o nosso departamento de projectos, no qual se estudam e desenham soluções luminicas através de software específico para o efeito.

Actualmente dispomos de soluções tecnológicas de iluminação com sistemas de controlo integrados a pedido para a indústria, escritórios, iluminação pública e viária, lojas de retalho, supermercados e centros comerciais, aplicações desportivas, parques de estacionamento, hotéis, hospitais, escolas e universidades... Temos soluções de iluminação criativas, personalizadas e adaptadas às necessidades dos nossos clientes e ajustadas à norma com um foco particular no bem estar do ser humano e na eficiência energética.



Luxometer



available

PIR



availa

OTA





# Tecnologías

Technologies

Technologies

Tecnologias

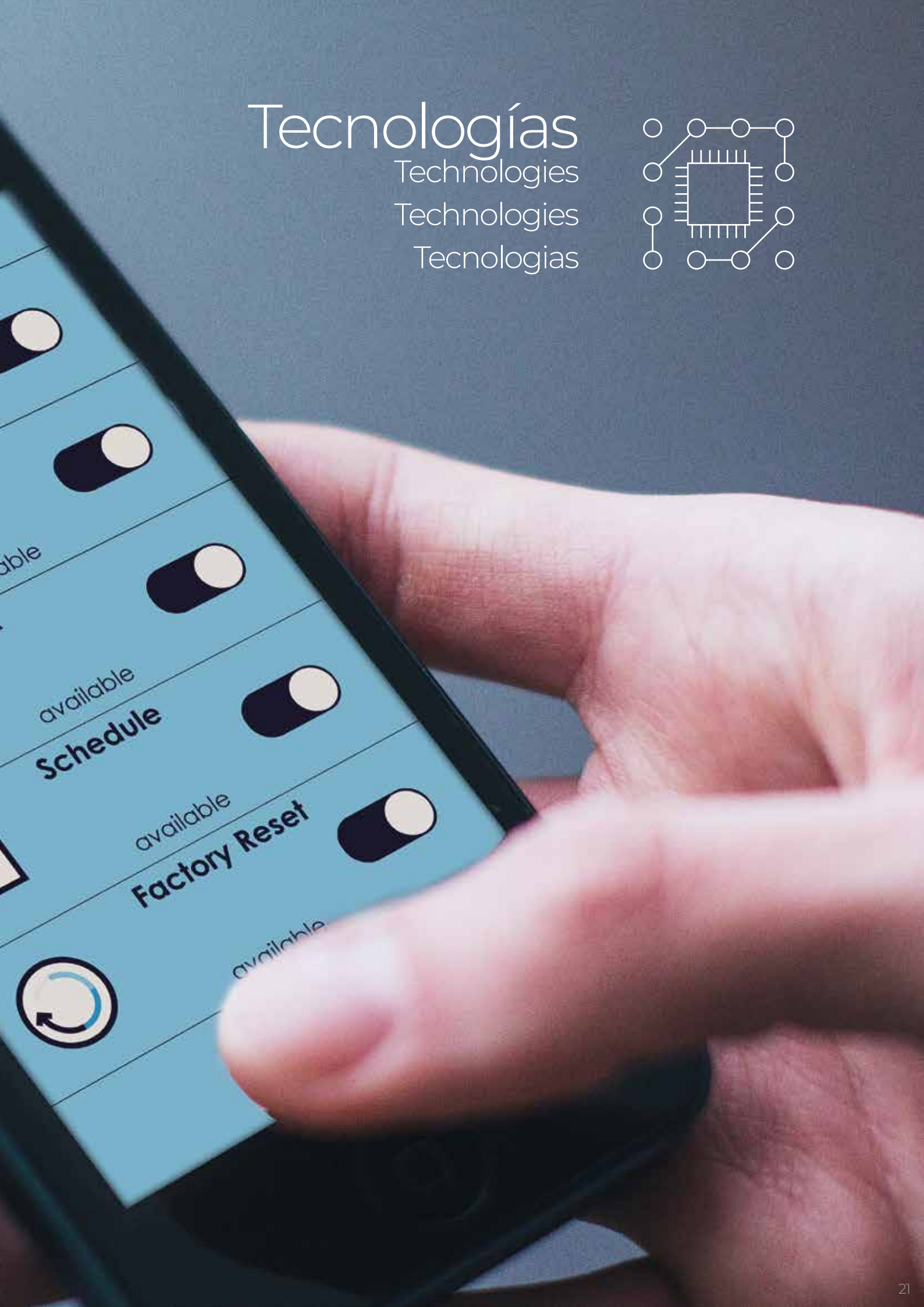
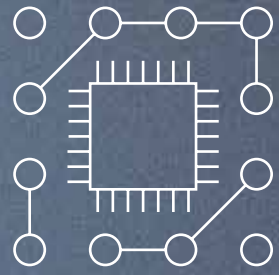



## HCB (High Cooled Box)

**Ñ:** La tecnología HCB (High Cooled Box) está enfocada en los box portaequipos de luminarias. Los box que la incorporan se dotan de la capacidad de generar unas condiciones de funcionamiento térmico óptimas para los equipos electrónicos que alojan. Esta tecnología proporciona un nuevo paradigma de gestión térmica para los componentes electrónicos que se encuentran en el interior de los equipos electrónicos de alimentación, entre los que se encuentran los driver LED. HCB aumenta la eficacia en la evacuación del calor generado para conseguir reducir las temperaturas de funcionamiento y alargar la vida útil en condiciones extremas de temperatura.

**E:** HCB technology is focused on the luminaire equipment box. The boxes that incorporate it are endowed with the capacity to generate optimum thermal operating conditions for the electronic equipment they house. This technology provides a new paradigm of thermal management for the electronic components that are inside the electronic power equipment, among which are the LED drivers. HCB increases efficiency in the evacuation of the heat generated to achieve lower operating temperatures and extend the service life in extreme temperature conditions.

**F:** La technologie HCB est axée sur la boîte d'équipement des luminaires. Les boîtiers qui l'intègrent sont dotés de la capacité de générer des conditions thermiques optimales pour les équipements électroniques qu'ils abritent. Cette technologie fournit un nouveau paradigme de gestion thermique pour les composants électroniques qui sont à l'intérieur de l'équipement d'alimentation électronique, parmi lesquels les drivers LED. Le HCB augmente l'efficacité de l'évacuation de la chaleur produite pour atteindre des températures de fonctionnement plus basses et prolonger la durée de vie dans des conditions de température extrêmes.

**P:** A tecnologia HCB é focada na caixa de equipamentos da luminária. As caixas que a incorporam são dotadas da capacidade de gerar condições operacionais térmicas ótimas para os equipamentos eletrônicos que alojam. Esta tecnologia fornece um novo paradigma de gerenciamento térmico para os componentes eletrônicos que estão dentro do equipamento de energia eletrônica, dentre os quais os drivers de LEDs. O HCB aumenta a eficiência na evacuação do calor gerado para atingir menores temperaturas operacionais e prolongar a vida útil em condições extremas de temperatura.



## TESS (Temperature Evacuation Skin System)

**Ñ:** La tecnología de tratamiento superficial TESS se basa en un microcompactado mecánico de la superficie del material que potencia la disipación térmica mejorando los resultados que se obtienen con tratamientos superficiales basados en lacados.

**E:** TESS surface treatment technology is based on a mechanical microcompact of the surface of the material that enhances thermal dissipation, improving the results obtained with surface treatments based on lacquers.

**F:** La technologie de traitement de surface TESS est basée sur un microcompact mécanique de la surface du matériau qui améliore la dissipation thermique, améliorant les résultats obtenus avec les traitements de surface à base de laques.

**P:** A tecnologia de tratamento de superfície TESS baseia-se em um microcompacto mecânico da superfície do material que melhora a dissipação térmica, melhorando os resultados obtidos com tratamentos de superfície à base de lacas.



## WAS (White Adaptive System)

---

**Ñ:** La tecnología WAS proporciona a las luminarias PRILUX la capacidad de cambiar tanto la cantidad de luz que proporcionan como la temperatura de color correlacionada, CCT. El cambio de estos dos parámetros se produce de forma dinámica e independiente en conjunción con un sistema de control. Gracias a la tecnología WAS, las luminarias PRILUX que la incorporan se adaptan a cualquier necesidad y aplicación de iluminación.

**E:** The WAS technology gives PRILUX luminaires the ability to change both the amount of light they provide and the correlated color temperature, CCT. The change of these two parameters occurs dynamically and independently in conjunction with a control system. Thanks to the WAS technology, the PRILUX luminaires that incorporate it adapt to any need and application of lighting.

**F:** La technologie WAS permet aux luminaires PRILUX de modifier à la fois la quantité de lumière qu'ils fournissent et la température de couleur corrélée, CCT. Le changement de ces deux paramètres se produit de manière dynamique et indépendante en conjonction avec un système de contrôle. Grâce à la technologie WAS, les luminaires PRILUX qui l'intègrent s'adaptent à tous les besoins et à toutes les applications d'éclairage.

**P:** A tecnologia WAS oferece às luminárias PRILUX a capacidade de alterar tanto a quantidade de luz que fornecem quanto a temperatura de cor correlacionada, CCT. A mudança desses dois parâmetros ocorre de forma dinâmica e independente em conjunto com um sistema de controle. Graças à tecnologia WAS, as luminárias PRILUX que a incorporam se adaptam a qualquer necessidade e aplicação da iluminação.



## Chromalife

---

**Ñ:** La tecnología CHROMALIFE®, basada en el color, se ha diseñado para cubrir las necesidades de iluminación de aplicaciones especiales de interior. Ofrece una luz focal que resalta, acentúa y aviva los colores específicos de cada producto así como sus características superficiales, potenciando la frescura, calidez, textura... según la aplicación especial a la que se destina.

**E:** The CHROMALIFE® technology based on the color has been designed to meet the needs of lighting in the applications for interior lighting. It offers focal light which emphasises, accentuates and intensifies the specific colors of each product and the superficial characteristics reinforcing the freshness, warmth, texture...depending on the special application to which it is assigned.

**F:** La technologie CHROMALIFE® basée sur la couleur a été conçue pour couvrir les nécessités d'éclairage dans des applications spéciales d'intérieur. Elle offre une lumière focale qui fait ressortir, accentue et avive les couleurs spécifiques de chaque produit ainsi que les caractéristiques superficielles en renforçant la fraîcheur, chaleur, texture...selon l'application spéciale à laquelle elle est destinée.

**P:** A tecnologia CHROMALIFE®, baseada na cor, foi concebida para cobrir as necessidades de iluminação em aplicações especiais de interior. Oferece uma luz focalizada que realça, acentua e aviva as cores específicas de cada produto assim como as suas características superficiais, potenciando a frescura, calor, textura... segundo a aplicação especial a que se destina.



## Overstorm

**Ñ:** La tecnología OVERSTORM está pensada para aquellas luminarias que normalmente se enfrentan a entornos eléctricamente agresivos. Dota al producto de tres esferas de protección: En la esfera exterior un protector contra sobretensiones independiente suprime las eventuales subidas de tensión producidas por la inducción de electricidad atmosférica en las líneas de alimentación. Este protector soporta la mayor parte de las sobretensiones por lo que está diseñado para facilitar su sustitución en caso de llegar a fin de vida. Cuando esto ocurre, el protector corta la alimentación al resto de la luminaria apagándola para asegurar que ningún pico de tensión se propague al resto del aparato. En la esfera intermedia los drivers están preparados para soportar picos de tensión de hasta 6 kV y 10kV. En la esfera nuclear la protección en el módulo LED se proporciona tanto en su entrada, para las pequeñas sobretensiones que no han sido filtradas por las esferas externas, como en los efectos capacitivos generados en la PCB del módulo producto de la actividad de electricidad atmosférica.

**E:** The OVERSTORM technology is designed for those luminaires that normally face electrically aggressive environments. It provides the product with three protection spheres: In the outer sphere, an independent surge protector suppresses possible voltage surges produced by the induction of atmospheric electricity in the power supply lines. This protector supports most of the surges so it is designed to facilitate its replacement in case of reaching end of life. When this occurs, the protector cuts the power to the rest of the luminaire by turning it off to ensure that no voltage spikes are propagated to the rest of the device. In the intermediate sphere the drivers are prepared to withstand voltage peaks of up to 6 kV and 10kV. In the nuclear field, the protection in the LED module is provided both in its input, for small surges that have not been filtered by external spheres, and in the capacitive effects generated in the PCB of the module product of atmospheric electricity activity.

**F:** La technologie OVERSTORM est conçue pour les luminaires qui sont normalement exposés à des environnements électriquement agressifs. Il fournit au produit trois sphères de protection: Dans la sphère extérieure, un limiteur de surtension indépendant supprime les surtensions possibles produites par l'induction de l'électricité atmosphérique dans les lignes d'alimentation. Ce protecteur supporte la plupart des surtensions donc il est conçu pour faciliter son remplacement en cas d'arrivée en fin de vie. Lorsque cela se produit, le protecteur coupe l'alimentation du reste du luminaire en l'éteignant pour s'assurer que les pointes de tension ne se propagent pas au reste de l'appareil. Dans la sphère intermédiaire, les pilotes sont prêts à supporter des pics de tension allant jusqu'à 6 kV et 10 kV. Dans la protection du domaine nucléaire dans le module LED, il est fourni à la fois à son entrée, pour les petites surtensions qui ne sont pas filtrés par les champs externes et les effets capacitifs engendrés dans l'activité du module produit PCB électricité atmosphérique.

**P:** A tecnologia OVERSTORM foi concebida para as luminárias que normalmente enfrentam ambientes eletricamente agressivos. Ele fornece ao produto três esferas de proteção: Na esfera externa, um filtro de linha independente suprime possíveis surtos de tensão produzidos pela indução de eletricidade atmosférica nas linhas de fornecimento de energia. Este protetor suporta a maioria dos surtos por isso é projetado para facilitar a sua substituição em caso de atingir o fim da vida. Quando isso ocorre, o protetor corta a energia para o resto da luminária, desligando-a para garantir que nenhum pico de tensão seja propagado para o resto do dispositivo. Na esfera intermediária, os motoristas estão preparados para suportar picos de tensão de até 6 kV e 10kV. No campo nuclear, a proteção no módulo de LED é fornecida tanto em sua entrada, para pequenos surtos que não foram filtrados por esferas externas, como nos efeitos capacitivos gerados no PCB do produto do módulo de atividade de eletricidade atmosférica.



## Systemshield

---

**Ñ:** La tecnología SYSTEMSHIELD está pensada para garantizar las horas de vida útil de luminarias instaladas en entornos en los que superar la temperatura máxima de operación es posible e incluso probable. Mediante sondas térmicas la luminaria conoce en todo momento su temperatura de funcionamiento. En caso de que esta temperatura supere la máxima permitida, la luminaria se autorregula de manera automática para reducir su potencia y mantener la temperatura de todos sus componentes dentro de los valores de seguridad que garantizan las horas de vida.

**E:** The SYSTEMSHIELD technology is designed to guarantee the useful life hours of luminaires installed in environments in which exceeding the maximum operating temperature is possible and even probable. Using thermal probes, the luminaire knows its operating temperature at all times. In case this temperature exceeds the maximum allowed, the luminaire automatically regulates itself to reduce its power and keep the temperature of all its components within the safety values that guarantee the hours of life.

**F:** La technologie SYSTEMSHIELD est conçue pour garantir la durée de vie utile des luminaires installés dans des environnements où un dépassement de la température maximale de fonctionnement est possible et même probable. En utilisant des sondes thermiques, le luminaire connaît sa température de fonctionnement à tout moment. Dans le cas où cette température dépasse le maximum autorisé, le luminaire se régule automatiquement pour réduire sa puissance et maintenir la température de tous ses composants dans les valeurs de sécurité qui garantissent les heures de vie.

**P:** A tecnologia SYSTEMSHIELD foi concebida para garantir o tempo de vida útil das luminárias instaladas em ambientes onde a temperatura máxima de funcionamento é possível e até provável. Utilizando sondas térmicas, a luminária sabe sempre a sua temperatura de funcionamento. Caso esta temperatura exceda o máximo permitido, a luminária regula-se automaticamente para reduzir a sua potência e manter a temperatura de todos os seus componentes dentro dos valores de segurança que garantem as horas de vida.



## Cora Manager CMR

**Ñ:** Gestión del alumbrado en el cuadro eléctrico que permite el control por grupos de las luminarias conectadas al centro de mando mediante la línea de alimentación (CMR) sin cableado adicional. Los centros de mando se comunican con la plataforma UNIO a través de la red móvil lo que permite la supervisión y configuración remota.

**E:** Lighting management in the electrical panel that allows group control of the luminaires connected to the control center via the power line (CMR) without additional wiring. The command centers communicate with the UNIO platform through the mobile network, which allows remote supervision and configuration.

**F:** Gestion de l'éclairage dans le tableau électrique qui permet le contrôle groupé des luminaires connectés au centre de contrôle via la ligne électrique (CMR) sans câblage supplémentaire. Les centres de commande communiquent avec la plate-forme UNIO via le réseau mobile, ce qui permet une supervision et une configuration à distance.

**P:** Gestão da iluminação no quadro elétrico que permite o controlo em grupo das luminárias ligadas ao centro de controlo através da linha de alimentação (CMR) sem cablagem adicional. Os centros de comando se comunicam com a plataforma UNIO através da rede móvel, que permite supervisão e configuração remota.



## Cora Manager PLC

**Ñ:** Gestión del alumbrado punto a punto desde la plataforma UNIO gracias a la comunicación bidireccional PLC (Power Line Communications) mediante la propia línea de alimentación entre las luminarias y los centros de mandos conectados al servicio.

**E:** Point-to-point lighting management from the UNIO platform thanks to bidirectional PLC (Power Line Communications) communication through the power line itself between the luminaires and the control centers connected to the service.

**F:** Gestion de l'éclairage point à point depuis la plate-forme UNIO grâce à la communication bidirectionnelle PLC (Power Line Communications) via la ligne électrique elle-même entre les luminaires et les centres de contrôle connectés au service.

**P:** Gestão da iluminação ponto-a-ponto a partir da plataforma UNIO graças à comunicação bidireccional PLC (Power Line Communications) através da própria linha de alimentação entre as luminárias e os centros de controlo ligados ao serviço.



## Cora Manager IoT

**Ñ:** Gestión remota del alumbrado punto a punto a través de la red móvil incorporando nodos IoT Zhaga Book18 que envían y reciben datos desde la UNIO mediante 2G/4G/NB-IoT. En este caso sin necesidad de elementos de comunicación auxiliares en el cuadro eléctrico.

**E:** Remote point-to-point lighting management through the mobile network incorporating Zhaga Book18 IoT nodes that send and receive data from the UNIO via 2G/4G/NB-IoT. In this case, without the need for auxiliary communication elements in the electrical panel.

**F:** Gestion de l'éclairage point à point à distance via le réseau mobile intégrant des nœuds IoT Zhaga Book18 qui envoient et reçoivent des données de l'UNIO via 2G/4G/NB-IoT. Dans ce cas, sans avoir besoin d'éléments de communication auxiliaires dans le tableau électrique.

**P:** Gerenciamento remoto de iluminação ponto a ponto através da rede móvel incorporando nós Zhaga Book18 IoT que enviam e recebem dados da UNIO via 2G/4G/NB-IoT. Neste caso, sem a necessidade de elementos auxiliares de comunicação no quadro elétrico.



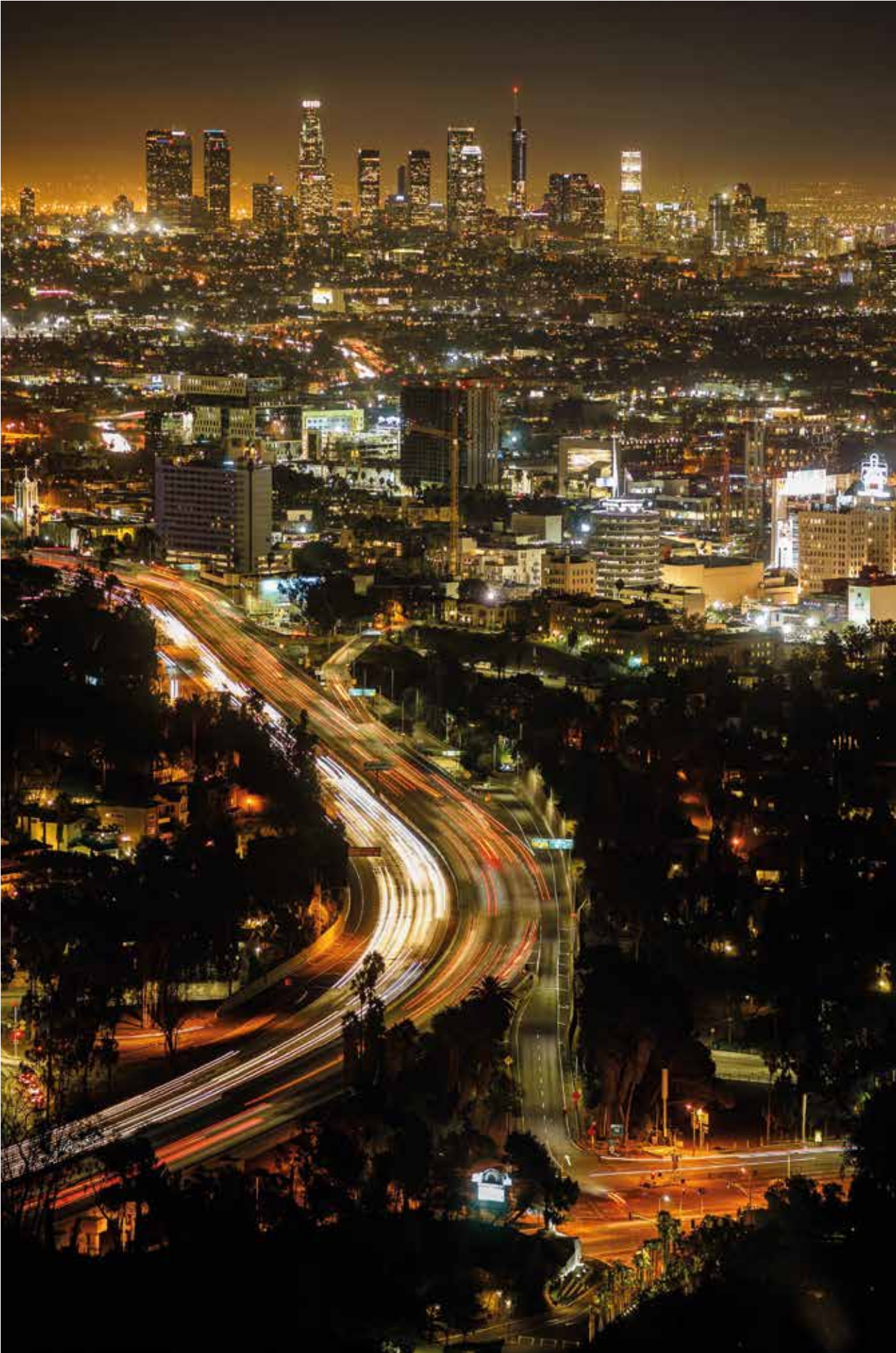



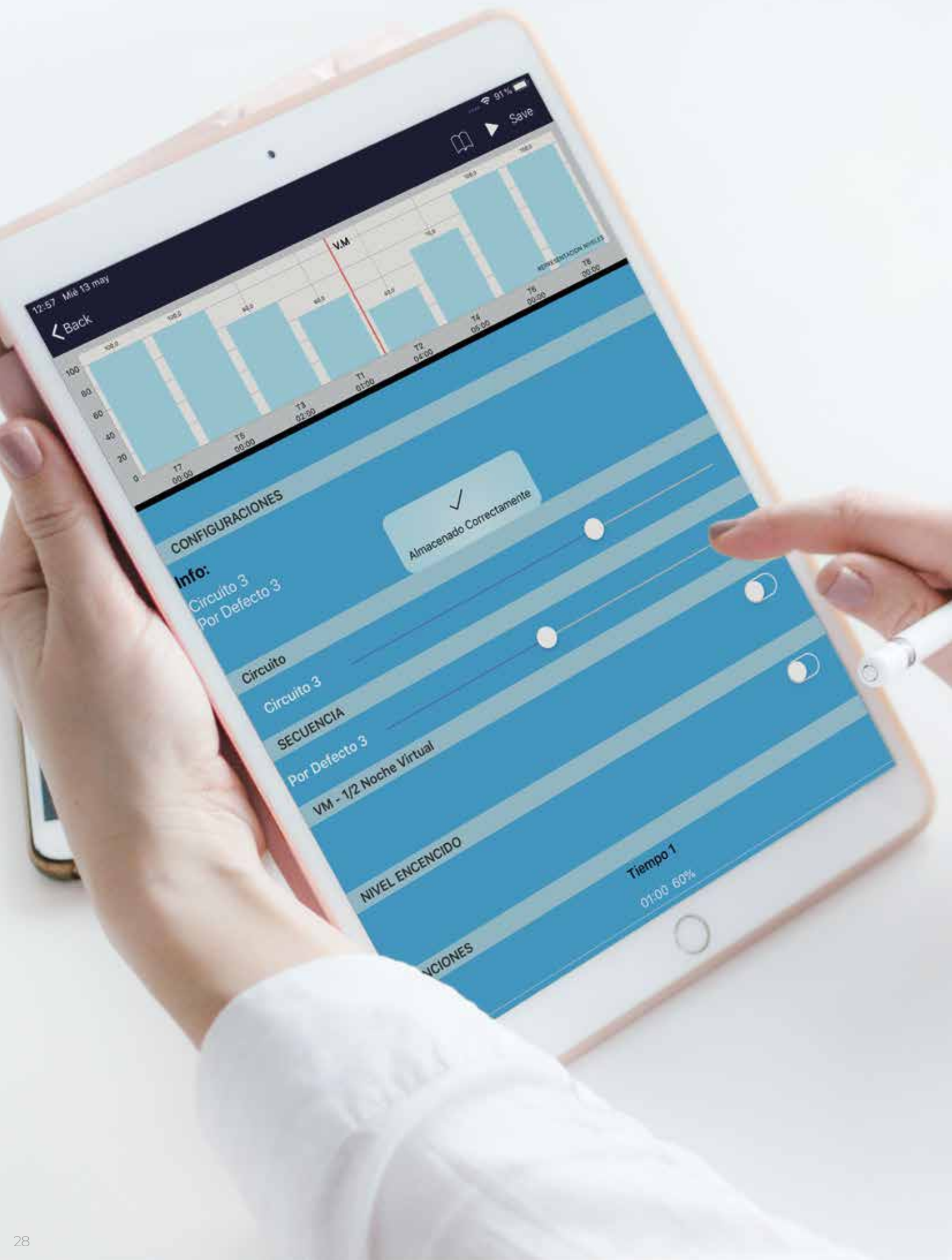

12:57 Mie 13 may

Back

Save

### CONFIGURACIONES

✓  
Almacenado Correctamente

Info:

Circuito 3

Por Defecto 3

Circuito

Circuito 3

SECUENCIA

Por Defecto 3

VM - 1/2 Noche Virtual

NIVEL ENCENDIDO

Tiempo 1

01:00 60%

ACIONES

# Soluciones

Solutions  
Des solutions  
Soluções

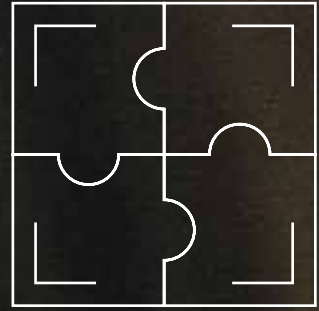

# SOLUCIONES PRILUX

PRILUX SOLUTIONS

SOLUTIONS PRILUX

SOLUÇÕES PRILUX



PACK BLUETOOTH



PACK AULAS



WAS OUTDOOR



SAFELIGHT



PACK CTE LUZ NATURAL

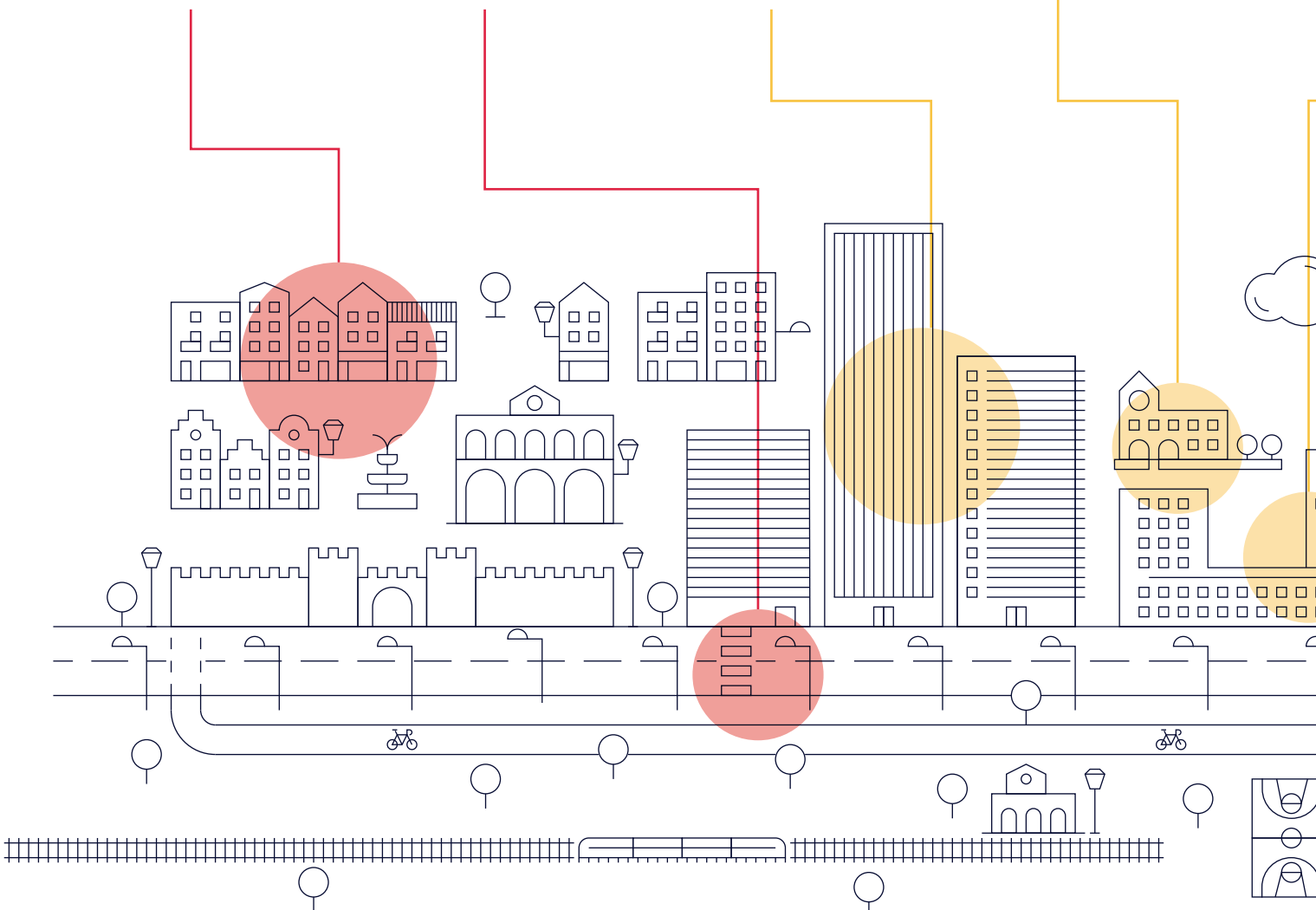



WAS INDOOR



CORA SPORTS



CORA MANAGER



CORA INDUSTRY LITE

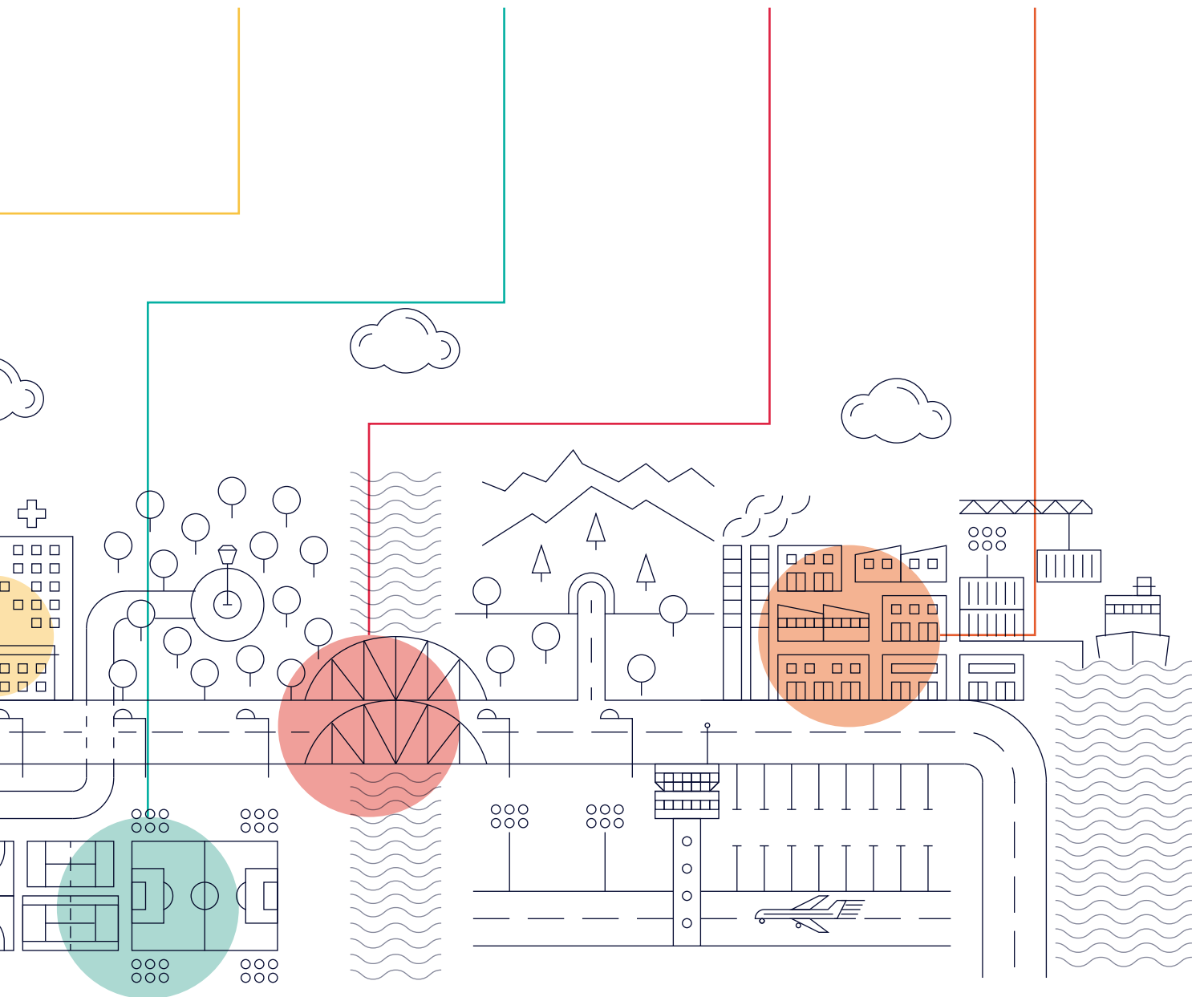



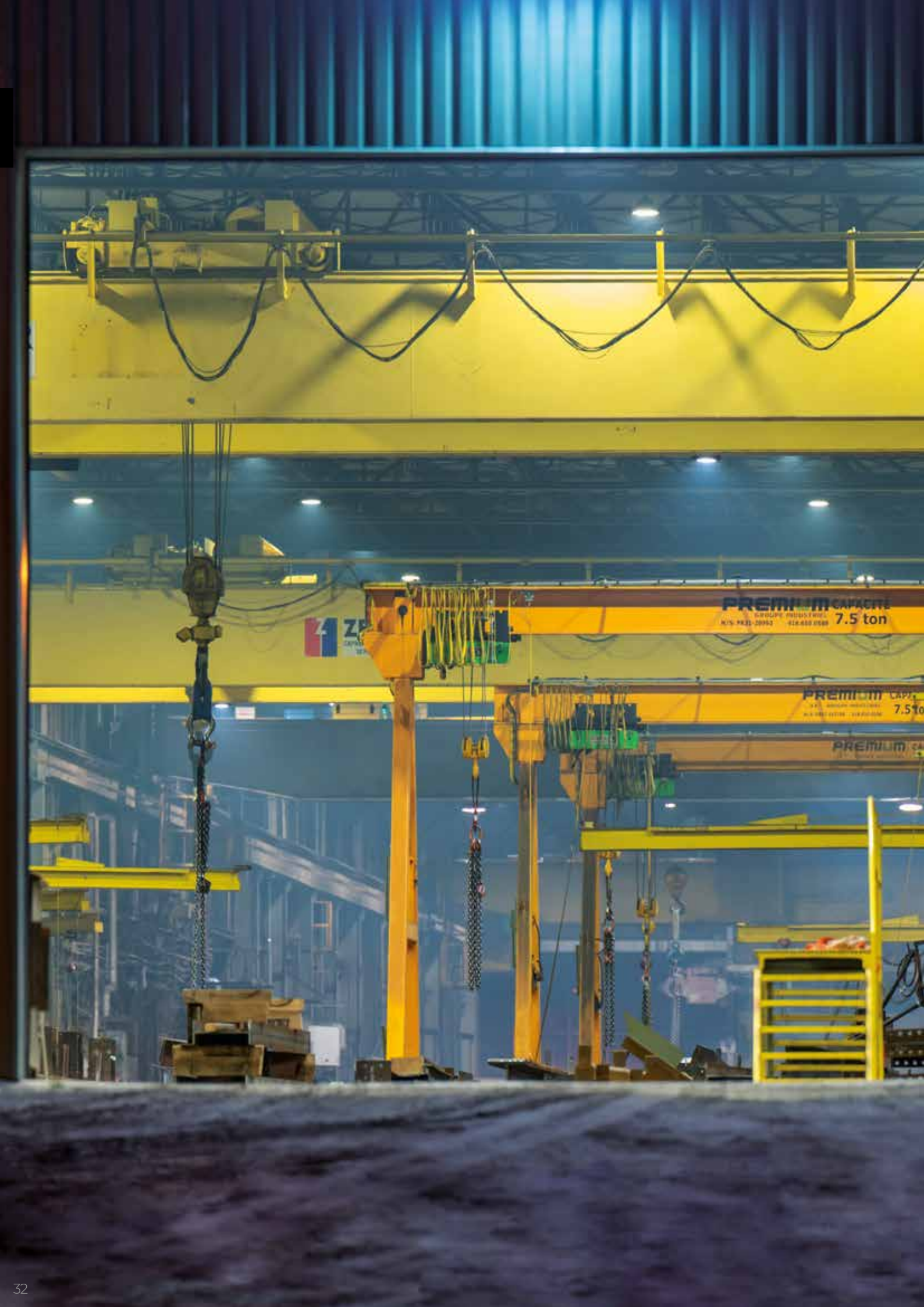

**PREMIUM CAPACITE**  
7.5 ton

**PREMIUM CAPACITE**  
7.5 ton

**PREMIUM CAPACITE**

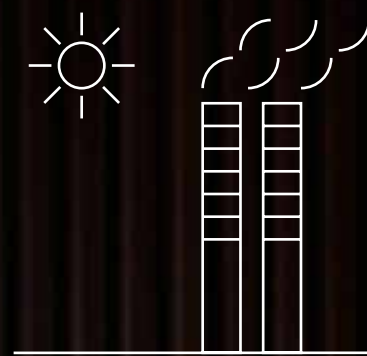

Soluciones de iluminación INDUSTRIAL  
INDUSTRIAL lighting solutions  
Solutions d'éclairage INDUSTRIELLE  
Soluções de iluminação INDUSTRIAL

# CORA INDUSTRY LITE



## Ñ

Cora Industry LITE es el nuevo sistema de control lumínico autónomo ideal para cualquier instalación industrial. Con una instalación sencilla, rápida e intuitiva, Cora Industry Lite supone un giro en la evolución de la industria aportando renovación, control y una completa gestión del alumbrado en fábricas y almacenes.

Dispone de sensor de luz integrado, regula el flujo emitido por las luminarias compensando el aporte de luz natural y consigue un aprovechamiento óptimo de la energía al monitorizar, de forma permanente, el nivel de luz ajustando la regulación de las luminarias hasta los niveles fijados

## F

Cora Industry LITE est le nouveau système de contrôle lumineux autonome parfait pour n'importe quelle installation industrielle. D'installation simple, rapide et intuitive, Cora Industry Lite marque un tournant dans l'évolution de l'industrie en apportant modernisation, contrôle et gestion intégrale de l'éclairage dans les usines et les entrepôts.

Il dispose d'un capteur de lumière intégré et régule le flux émis par les luminaires en compensant l'apport de lumière naturelle. En outre, il optimise l'utilisation de l'énergie en contrôlant en permanence le niveau de lumière grâce au réglage des luminaires aux niveaux fixés.

## E

Cora Industry LITE is the new standalone lighting control system, which is ideal for any industrial installation. With simple, quick, intuitive installation, Cora Industry Lite represents a turning point in development in the industry, providing renewal, control and full management of lighting in factories and warehouses.

It has a built-in light sensor, regulates the flux emitted by the luminaires to compensate for the contribution from natural light and achieves optimal energy use by continually monitoring the light level to adjust the luminaires to the levels set.

## P

Cora Industry LITE é um novo sistema de controlo lumínico autónomo perfeito para qualquer instalação industrial. Com uma instalação simples, rápida e intuitiva, Cora Industry Lite representa um ponto de viragem na evolução da indústria, proporcionando renovação, controlo e uma completa gestão da iluminação em fábricas e armazéns.

Dispõe de sensor de luz integrado, regula o fluxo emitido pelas luminárias compensando o aporte de luz natural e consegue um aproveitamento ótimo da energia ao monitorizar permanentemente o nível de luz, ajustando a regulação das luminárias até aos níveis fixados







# Funcionalidades

## Functionalities / Fonctionnalités / Funcionalidades



**Control eficiente de la instalación**  
Efficient facility control  
Contrôle efficient de l'installation  
Controlo eficiente da instalação

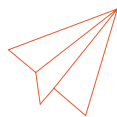

**Instalación sencilla e intuitiva**  
Simple, intuitive installation  
Installation simple et intuitive  
Instalação simples e intuitiva



**Sistema autónomo de control**  
Standalone control system  
Système de contrôle autonome  
Instalação simples e intuitiva



**Regulación precisa DALI Broadcast de hasta 64 drivers.**  
Precise DALI Broadcast regulation of up to 64 drivers  
Régulation précise DALI Broadcast allant jusqu'à 64 drivers.  
Regulación precisa DALI Broadcast de hasta 64 drivers.



**Configuración directa del nivel de luz mediante pulsador.**  
Direct light level setting by push button  
Configuration directe du niveau de lumière par bouton.  
Configuración directa del nivel de luz mediante pulsador.

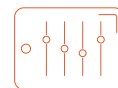

**Configuración avanzada desde la aplicación iOS Play LITE**  
Advanced setting from the iOS Play LITE app  
Configuration avancée à partir de l'application iOS Play LITE  
Configuración avanzada desde la aplicación iOS Play LITE



## Cora Industry LITE /

Iluminación de nave industrial  
 Industrial building lighting  
 Éclairage de bâtiment industriel  
 Iluminação de edifícios industriais

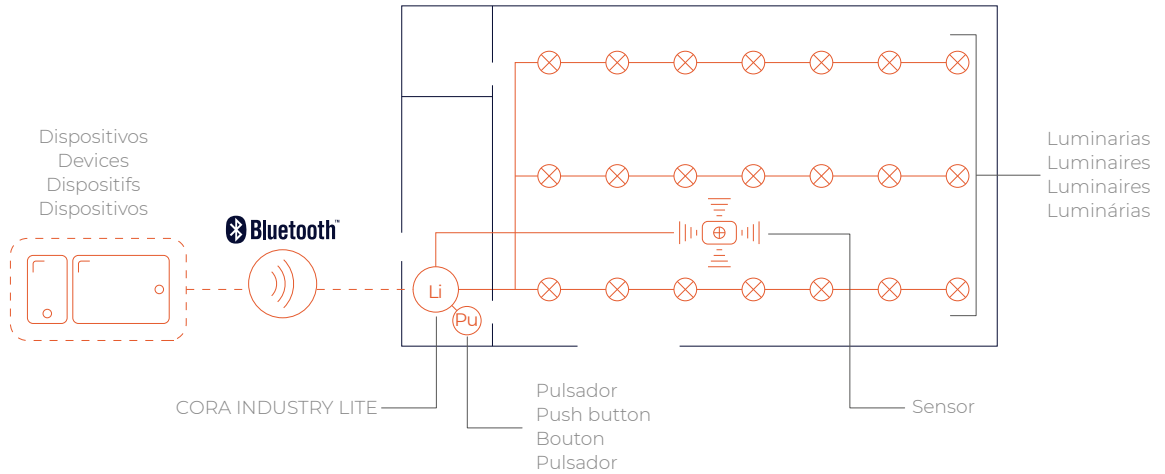

**Ñ:** Entre sus características principales, destaca la configuración de la regulación automática del nivel de luminosidad mediante un pulsador sin necesidad de instalar ningún tipo de software, a excepción de configuraciones avanzadas a través de la app IOS Play LITE con la posibilidad de incorporar redes de detección de presencia

**E:** Outstanding among its main features of the automatic regulation of the luminosity level pushing button with no need to install any software, except for advanced settings through the IOS Play LITE app with the possibility of incorporating presence detection networks.

**F:** La configuration de la régulation automatique du niveau de luminosité grâce à un bouton ne nécessitant aucune installation de logiciel, à l'exception des configurations avancées via l'application IOS Play LITE avec la possibilité d'intégrer des réseaux de détection de présence

**P:** Entre as suas principais características destaca-se a configuração da regulação automática do nível de luminosidade através de um botão sem necessidade de instalar qualquer tipo de software, exceto configurações avançadas, através do aplicativo IOS Play LITE com a possibilidade de incorporar redes de detecção de presença.



**Luxómetro integrado**  
 Integrated luxometer  
 Luxomètre intégré  
 Luxómetro integrado

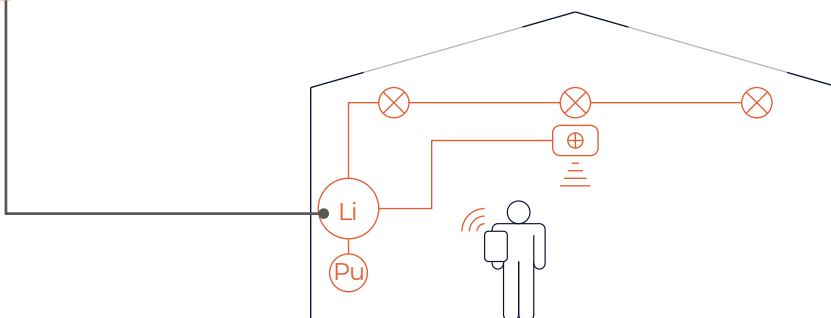



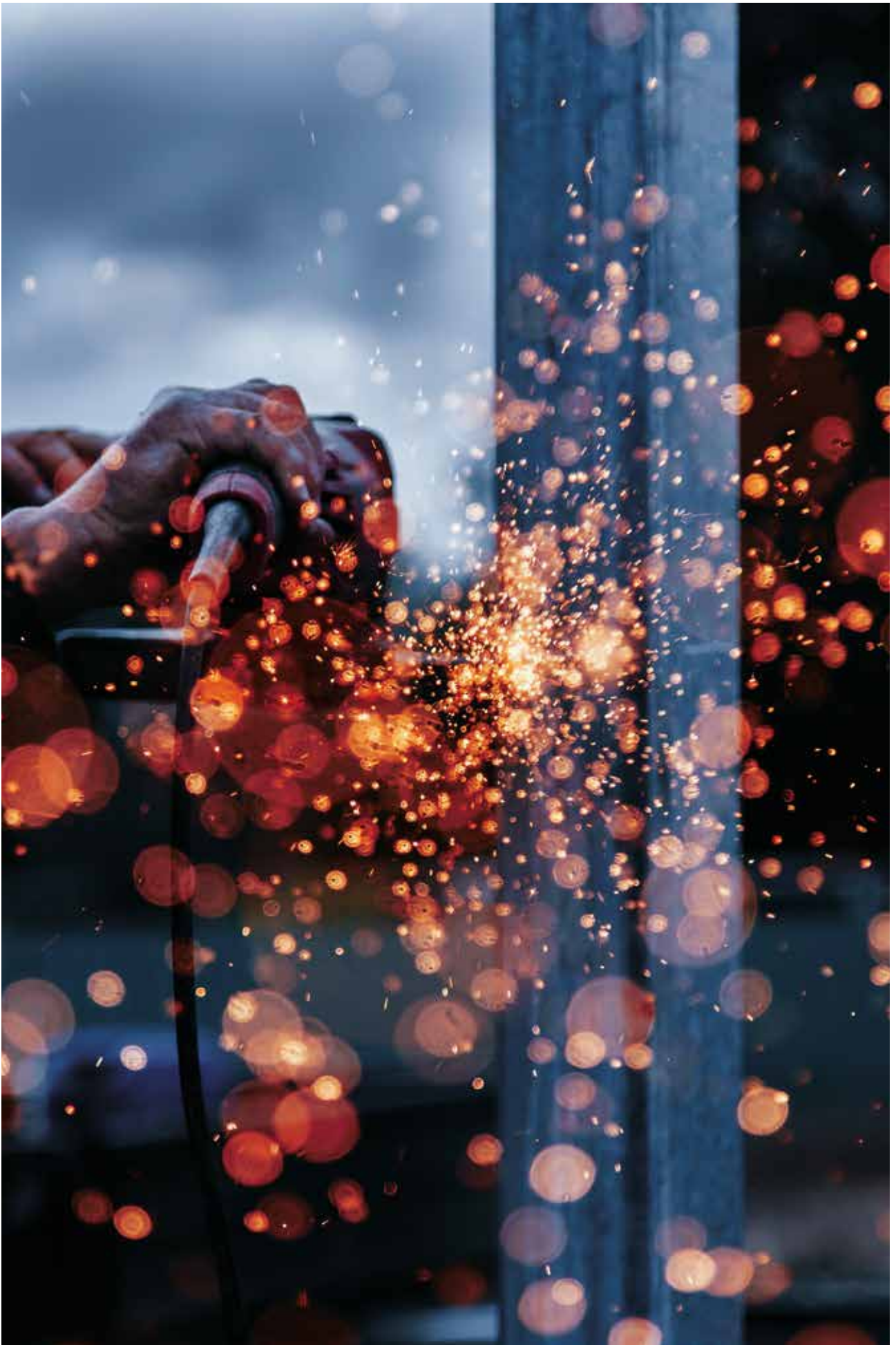

# Luminarias compatibles

Compatible luminaires / Luminaires compatibles / Luminárias compatíveis

Hexagon Zenit 48 Leds \*



Hexagon Zenit 144 Leds \*



Berlín Avant \*



Benzine Elite Empotrar \*



Benzine Elite Superficie \*



Hexagon Play óptima



Hexagon Play Match Unity \*



\* Bajo pedido  
On request  
Sur commande  
A pedido

AVISO / WARNING / AVERTISSEMENT / AVISO



Las soluciones Pack CTE son de aplicación exclusivas en luminarias provistas de sistema DALI.

CTE Pack solutions apply exclusively to luminaires equipped with a DALI system.

Les solutions CTC appliquent exclusivement aux luminaires équipés d'un système DALI.

As soluções da Pack CTE aplicam-se exclusivamente a luminárias equipadas com um sistema DALI.





SPAIN 2021 | 25<sup>TH</sup> IHF WOMEN'S WORLD CHAMPIONSHIP

Callaghan

FUNDACIÓN TRINIDAD ALFONSO

IBERDROLA

belvella

WWW.IHF.INFO

Santander

COMUNITAT VALÈNCIA

IBERDROLA

IBERDROLA





Soluciones de iluminación DEPORTIVAS  
SPORTS lighting solutions  
Solutions d'éclairage SPORTIVES  
Soluções de iluminação DESPORTIVAS



# CORA SPORTS

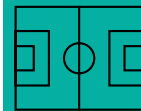

## Ñ

CORA SPORTS es la familia de dispositivos desarrollado por Prilux para controlar las luminarias DALI de una instalación nueva o ya existente, tanto de interior como de exterior, gracias a la tecnología inalámbrica Bluetooth 5.0.

Esta tecnología es la más eficiente, fácil de implementar y escalar para aplicaciones de iluminación profesional. Permite trabajar en malla con las luminarias y crear redes inteligentes de comunicación. Especialmente recomendado en instalaciones provistas de torres y/o grupo de luminarias para poder trabajar de forma conjunta con cada uno.

## F

CORA SPORTS est la famille d'appareils développé par Prilux pour piloter les luminaires DALI d'une installation neuve ou existante, aussi bien d'intérieur que d'extérieur, grâce à la technologie sans fil Bluetooth 5.0.

Cette technologie est la plus efficace, facile à mettre en place et évolutive pour les applications d'éclairage professionnel. Elle permet de travailler en réseau avec les luminaires et de créer des réseaux intelligents de communication. Spécialement recommandé pour installations équipées de mats et/ou groupes de luminaires, pour pouvoir travailler de forme conjointe avec chacun d'entre eux.

## E

CORA SPORTS is the family of devices by Prilux to control DALI light fixtures in new or existing installations, indoors or outdoors, using Bluetooth 5.0 wireless technology.

Technology that is more efficient and easier to deploy and scale for professional lighting applications. It can work in a meshed arrangement with the light fixtures and to create smart communication networks. Especially recommended in installations with towers and/or groups of light fixtures to make it possible to operate them as a group or individually.

## P

CORA SPORTS é a família de dispositivos desenvolvido pela Prilux para controlar as luminárias DALI de uma instalação nova ou já existente, tanto de interior como de exterior, graças à tecnologia sem fios Bluetooth 5.0.

Esta tecnologia é a mais eficiente, fácil de implementar e escalar para aplicações de iluminação profissional. Permite trabalhar em malha com as luminárias e criar redes inteligentes de comunicação. Especialmente recomendado em instalações com torres e/ou grupo de luminárias para poder trabalhar de forma conjunta com cada um.



Cora Stadium

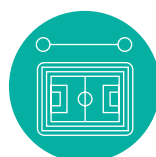

Cora Master





25TH IHF WOMEN'S WORLD CHAMPIONSHIP **SPAIN 2021**

TRIVOCATION BEBOP molten For the real game aqua service IBERDROLA Callaghan

Agbar  
Callaghan  
IBERDROLA  
aqua service  
molten  
TRIVOCATION BEBOP

Palacio de deportes  
Torrevieja (Alicante)

# Funcionalidades

Functionalities / Fonctionnalités / Funcionalidades

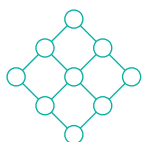

## Redes y grupos de luminarias

Networks and groups of luminaires  
Réseaux et groupes de luminaires  
Redes e grupos de luminárias



## Apagado / Encendido

ON / OFF  
Allumage / Extinction  
Apagado / Acesso



## Escenas predeterminadas

Networks and groups of luminaires  
Scènes prédéterminées  
Cenários predefinidos



## Efectos dinámicos

Dynamic effects  
Effets dynamiques  
Efeitos dinâmicos



## Configuración de actividad

Activity Settings  
Configuration d'activité  
Configuração de atividade



## Optimización de consumos

Consumption optimization  
Optimisation des consommations  
Otimização de consumos



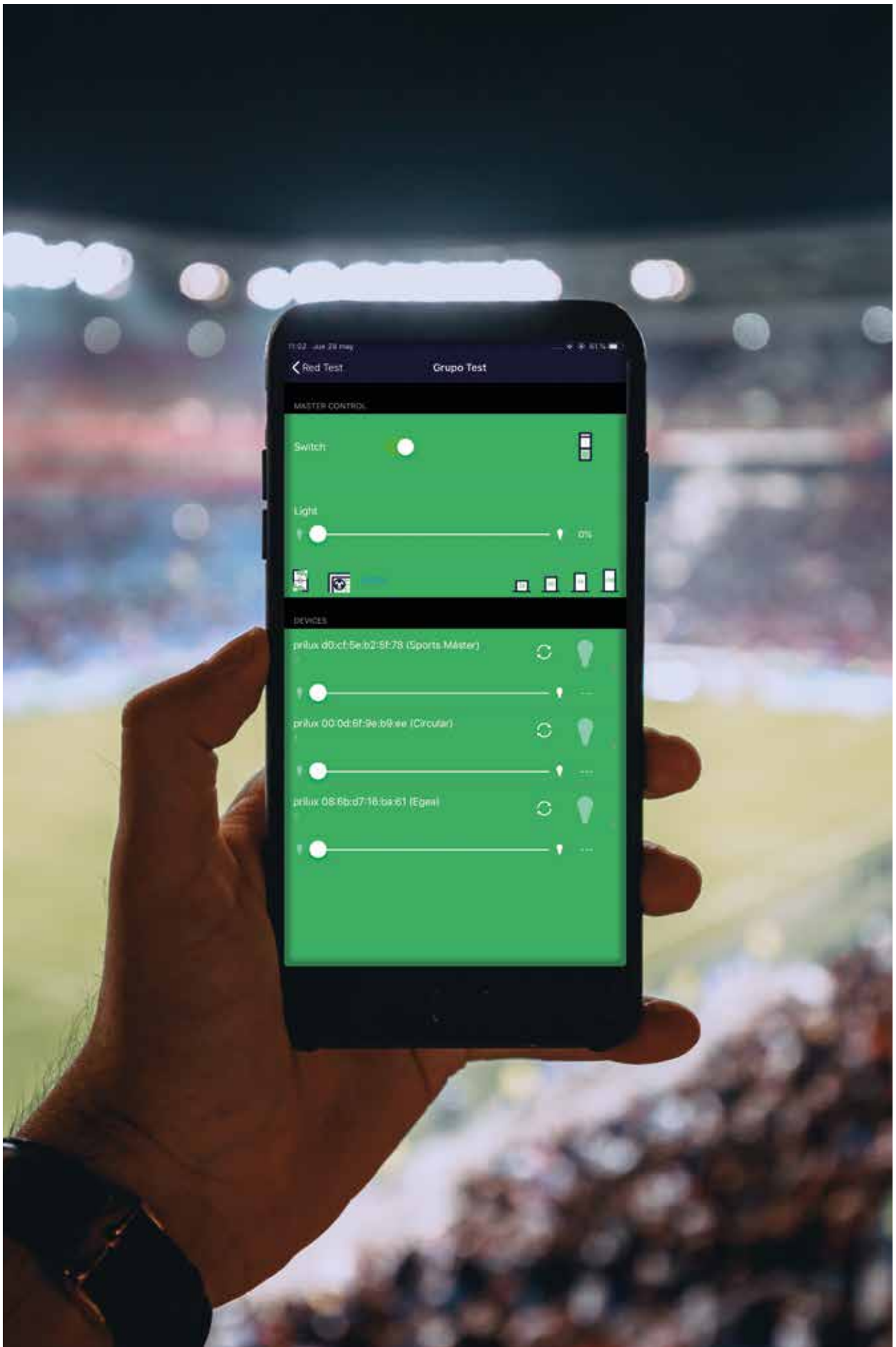



Pabellón multideporte  
L'Alcora (Valencia)

# Cora Sports Stadium



Grandes distancias  
Long distances  
Grandes distancias  
Grandes distâncias



Hasta 200 metros de alcance  
Range up to 200 metres  
Jusqu'à 200 mètres de portée  
Até 200 metros de alcance



Controla hasta  
Controls up to  
Contrôle Maximum  
Controla até 30  
30 CORA SPORTS / STADIUM



## Cora Stadium

Iluminación de estadio de fútbol  
Football stadium lighting  
Éclairage de Sade de football  
Iluminação de estádio de futebol

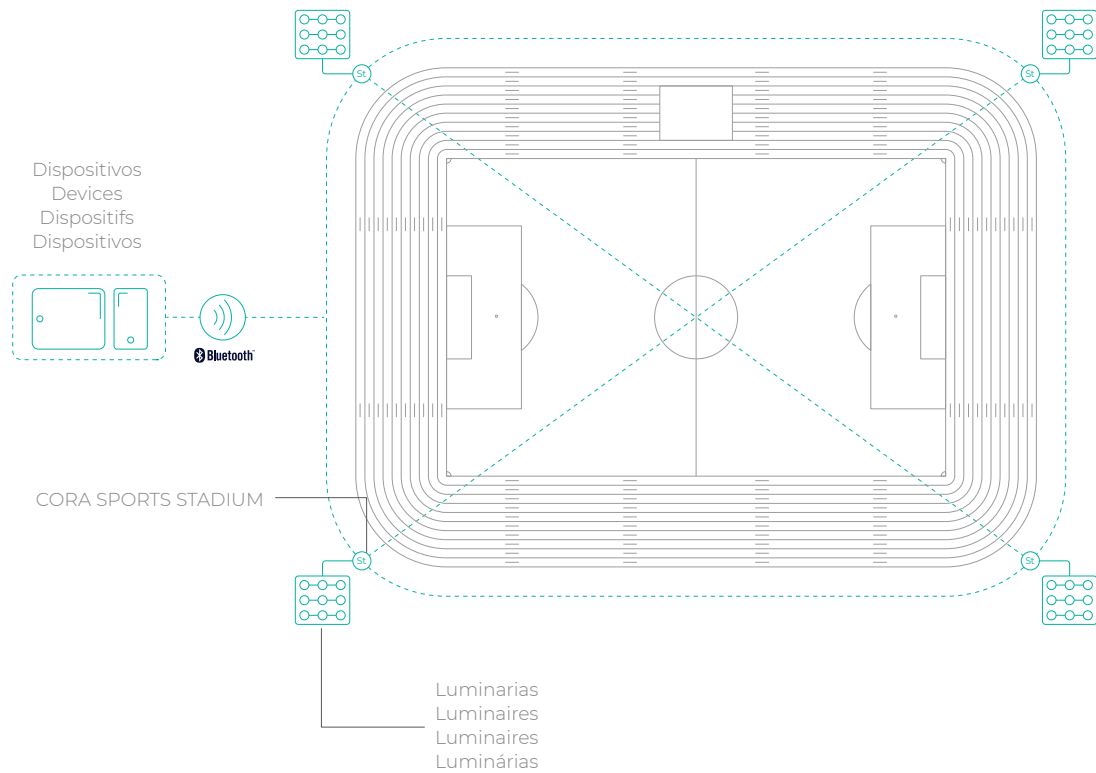



Campo Municipal "El Barxell"  
Petrer (Alicante)

# Cora Master

Flexibilidad total para cualquier instalación

Total flexibility for any installation

Flexibilité totale pour tout genre d'installations

Flexibilidade total para qualquer instalação



Solución de control  
Control solution  
Solution de contrôle  
Solução de controlo



Hasta 200 metros de alcance  
Range up to 200 metres  
Jusqu'à 200 mètres de portée  
Até 200 metros de alcance



Controla hasta  
Controls up to  
Contrôle Maximum  
Controla até 30  
30 CORA SPORTS / STADIUM



**Ñ:** El dispositivo inalámbrico CORA SPORTS MASTER controla, sin necesidad de cableado adicional y mediante un sencillo pulsador, grupos de luminarias conectadas de manera colectiva a un dispositivo CORA SPORTS STADIUM. Además, para facilitar una mayor flexibilidad, es posible realizar tareas de gestión a través de la aplicación PLAYMESH. El dispositivo permite la sectorización de la iluminación adaptándola a la actividad a realizar en cada momento.

**E:** The CORA SPORTS MASTER wireless device controls groups of light fixtures that are connected to a CORA SPORTS STADIUM device, with a simple button and without the need for additional wiring. The device makes it possible to control lighting by sectors, adapting it to the activity at any given time. For greater flexibility, management tasks can be carried out using the PLAYMESH application.

**F:** Le dispositif CORA SPORTS MASTER permet le pilotage, sans câblage supplémentaire, par un bouton-poussoir simple, des groupes de luminaires connectés de forme collective à un dispositif CORA SPORTS STADIUM. Pour favoriser une plus grande flexibilité, il est possible de réaliser des tâches de gestion par l'intermédiaire de l'application PLAYMESH. Le dispositif permet la sectorisation de l'éclairage en l'adaptant à l'activité à effectuer à tout moment.

**P:** O dispositivo sem fios CORA SPORTS MASTER controla, sem necessidade de cablagem adicional e através de um simples botão, grupos de luminárias ligadas de forma conjunta a um dispositivo CORA SPORTS STADIUM. Além disso, para conferir uma maior flexibilidade, é possível realizar tarefas de gestão através da aplicação PLAYMESH. O dispositivo permite a sectorização da iluminação, adaptando-a à atividade a realizar em cada momento.



## Cora Master

Iluminación de estadio de fútbol  
Football stadium lighting  
Éclairage de Stade de football  
Iluminação de estádio de futebol

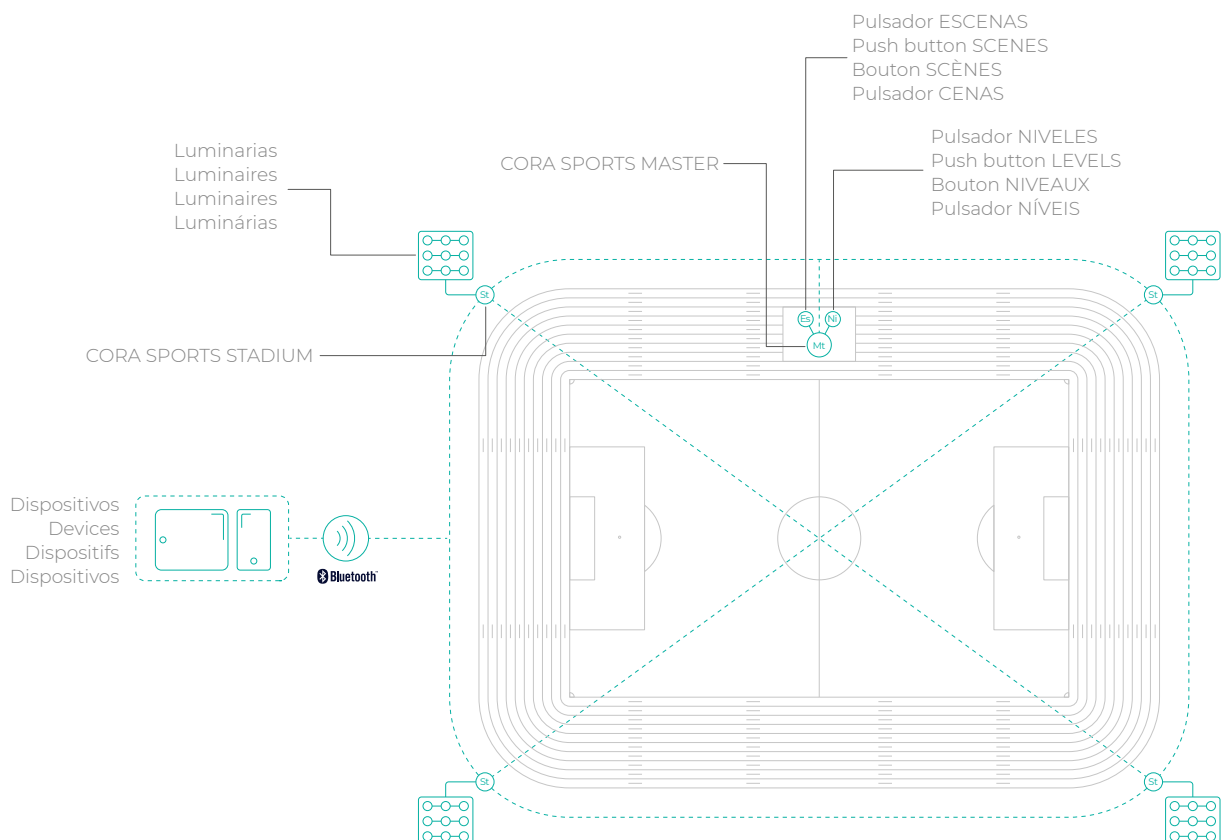



# Luminarias compatibles

Compatible luminaires / Luminaires compatibles / Luminárias compatíveis

## Hexagon Play Óptima

48LEDs 144W/1x, 2x, 3x, 4x, 5x (Box / integrado, integrated, intégré)



## Hexagon Play Was

1X, 2X, 2X (Box / integrado, integrated, intégré)



## Hexagon Play Match Unity

144LEDs/2X (Box / integrado, integrated, intégré)



## Hexagon Play Match

144 LEDS/2X, 3X, 4X (Box / remoto, remote, déporté)



## Hexagon Play Arena

2X, 3X, 4X (Box / remoto, remote, déporté)



## Hexagon Play RGBW

1X, 2X (Box / integrado, integrated, intégré)



## Hexagon Play RGBW Remoto

1X, 2X (Box / remoto, remote, déporté)



Nantes Play



Nantes L Play



Nantes XL Play







# SMARTCITIES

Soluciones

Solutions

Des solutions

Soluções





## Ñ

UNIO Smart Cities. Gestión y control optimizado del alumbrado de las ciudades modernas .

UNIO es la plataforma de telegestión de Prilux que permite una mayor facilidad a la hora de tomar decisiones óptimas en tiempo real, gracias a obtención de un diagnóstico generado tras la recopilación de datos del sistema remoto de luminarias punto a punto.

## F

UNIO Smart Cities. Gestion et contrôle optimisés de l'éclairage dans les villes modernes.

UNIO est la plate-forme de télégestion Prilux qui facilite la prise de décisions optimales en temps réel, grâce à l'obtention d'un diagnostic généré après la collecte des données du système de luminaires point à point à distance.

## E

UNIO Smart Cities. Optimized management and control of lighting in modern cities.

UNIO is the Prilux telemanagement platform that makes it easier to make optimal decisions in real time, thanks to obtaining a diagnosis generated after collecting data from the remote point-to-point luminaire system.

## P

UNIO Cidades Inteligentes. Gestão e controlo otimizados da iluminação nas cidades modernas.

UNIO é a plataforma de telegestão Prilux que facilita a tomada de decisões ótimas em tempo real, graças à obtenção de um diagnóstico gerado após a coleta de dados do sistema remoto de luminárias ponto a ponto.





**Mejoras de tiempo de respuesta y de servicio ofrecido.**

Improvements in response time and service offered.  
 Amélioration du temps de réponse et du service offert.  
 Melhorias no tempo de resposta e no serviço oferecido.



**Reducción de costes operativos.**

Reduction of operating costs.  
 Réduction des coûts d'exploitation.  
 Redução de custos operacionais.

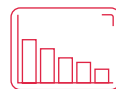

**Control y reducción del consumo energético.**

Control and reduction of energy consumption.  
 Contrôle et réduction de la consommation d'énergie.  
 Controle e redução do consumo de energia.



**Mejora la calidad y eficiencia del alumbrado público.**

Improves the quality and efficiency of street lighting.  
 Améliore la qualité et l'efficacité de l'éclairage public.  
 Melhora a qualidade e eficiência da iluminação pública.

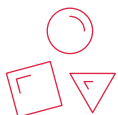

**Facilita la toma de decisiones en tiempo real.**

Facilitates real-time decision making.  
 Il facilite la prise de décision en temps réel.  
 Facilita a tomada de decisões em tempo real.



**Sistema remoto fácil y flexible.**

Easy and flexible remote system.  
 Système à distance simple et flexible.  
 Sistema remoto fácil e flexível.



**Uso sencillo e intuitivo de la interfaz.**

Simple and intuitive use of the interface.  
 Utilisation simple et intuitive de l'interface.  
 Uso simples e intuitivo da interface.

# ¿Qué aporta una buena iluminación?

## Ñ

Un alumbrado adecuado garantiza a las ciudades beneficios tangibles para todos aquellos que participan en ella: seguridad vial y ciudadana, ahorros energéticos de hasta 70%, sostenibilidad y cuidado del medio ambiente, sencillez en la instalación y el mantenimiento, además de reducción de costes operativos.

## F

Un éclairage adéquat assure aux villes des avantages tangibles pour tous ceux qui y participent : sécurité routière et citoyenne, économies d'énergie jusqu'à 70%, durabilité et respect de l'environnement, simplicité d'installation et d'entretien, en plus de réduire les coûts d'exploitation.

## E

Adequate lighting ensures cities tangible benefits for all those who participate in it: road and citizen safety, energy savings up to 70%, sustainability and care for the environment, simplicity in installation and maintenance, in addition to reducing operating costs.

## P

A iluminação adequada garante as cidades benefícios tangíveis para todos os que dela participam: segurança viária e cidadã, economia de energia até 70%, sustentabilidade e cuidado com o meio ambiente, simplicidade na instalação e manutenção, além de reduzir os custos operacionais.



**Usuarios / Ciudadanos**  
Users / Citizens  
Utilisateurs / Citoyens  
Usuários / Cidadãos



**Ingenierías**  
Engineering  
Ingénierie  
Engenharia



**Administración pública**  
Public administration  
Administration publique  
Administração pública



**Instaladores**  
Installers  
Installateurs  
Instaladores



# Funcionalidades

## Functionalities / Fonctionnalités / Funcionalidades



**Monitorización y control**  
Monitoring and control  
Surveillance et contrôle  
Monitoramento e controle



**Gestión de alertas**  
Alert management  
Gestion des alertes  
Gerenciamento de alertas



**Análisis de datos**  
Data analysis  
Analyse de données  
Análise de dados



**Confección y gestión de inventario de la infraestructura de alumbrado**  
Inventory management of lighting infrastructure  
Gestion de l'inventaire des infrastructures d'éclairage  
Elaboração e gestão de inventário de infraestrutura de iluminação



**Reloj astronómico**  
Astronomical clock  
Horloge astronomique  
Relógio astronômico



**Dashboard de visión ecológica**  
Ecological vision dashboard  
Tableau de bord vision écologique  
Painel de visão ecológica



**Métodos de seguridad**  
Security methods  
Méthodes de sécurité  
Métodos de segurança

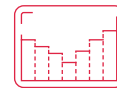

**Programación de perfiles**  
Programming dimming profiles  
Programmer des profils de gradation  
Programar perfis de escurecimento



**Actualización remota del firmware (OTA)**  
Firmware update remotely (OTA)  
Mise à jour du firmware à distance (OTA)  
Atualização de firmware remotamente (OTA)



**Módulo GMAO**  
CMMS module  
Module GMAO  
Módulo CMMS

# CORA MANAGER

Solución para city

Solution for city

Solutions pour city

Solução para cidade



## Ñ

Una de las piezas clave para lograr el camino hacia las ciudades inteligentes lo compone la iluminación. Los sistemas de gestión de alumbrado avanzan a pasos agigantados dando prioridad a objetivos primordiales como la calidad del servicio, la reducción de costes y el cuidado del medio ambiente.

CORA Manager es el sistema de control desarrollado por Prilux que, junto con nuestras luminarias compatibles que proporciona una gestión inteligente del alumbrado público manteniendo una armonía entre el desarrollo sostenible y la calidad de vida de los ciudadanos, a la vez que favorece la seguridad y el ahorro.

## E

One of the key pieces to achieve the path towards smart cities is lighting. Lighting management systems are advancing by leaps and bounds, prioritizing primary objectives such as service quality, cost reduction and care for the environment.

CORA Manager is the control system developed by Prilux that, together with our compatible luminaires that provides intelligent management of public lighting, maintaining harmony between sustainable development and quality of life for citizens, while promoting safety and saving.

## F

L'éclairage est l'un des éléments clés pour tracer la voie vers les villes intelligentes. Les systèmes de gestion de l'éclairage progressent à pas de géant, privilégiant des objectifs prioritaires tels que la qualité de service, la réduction des coûts et le respect de l'environnement.

CORA Manager est le système de contrôle développé par Prilux qui, associé à nos luminaires compatibles qui permet une gestion intelligente de l'éclairage public, en maintenant l'harmonie entre le développement durable et la qualité de vie des citoyens, tout en favorisant la sécurité et l'économie.

## P

Uma das peças-chave para alcançar o caminho para as cidades inteligentes é a iluminação. Os sistemas de gerenciamento de iluminação estão avançando a passos largos, priorizando objetivos primários como qualidade de serviço, redução de custos e cuidado com o meio ambiente.

CORA Manager é o sistema de controle desenvolvido pela Prilux que, em conjunto com as nossas luminárias compatíveis que permite uma gestão inteligente da iluminação pública, mantendo a harmonia entre o desenvolvimento sustentável e a qualidade de vida dos cidadãos, ao mesmo tempo que promove a segurança e a poupança.



Cora Manager CMR



Cora Manager PLC



Cora Manager IoT





# Cora Manager CMR

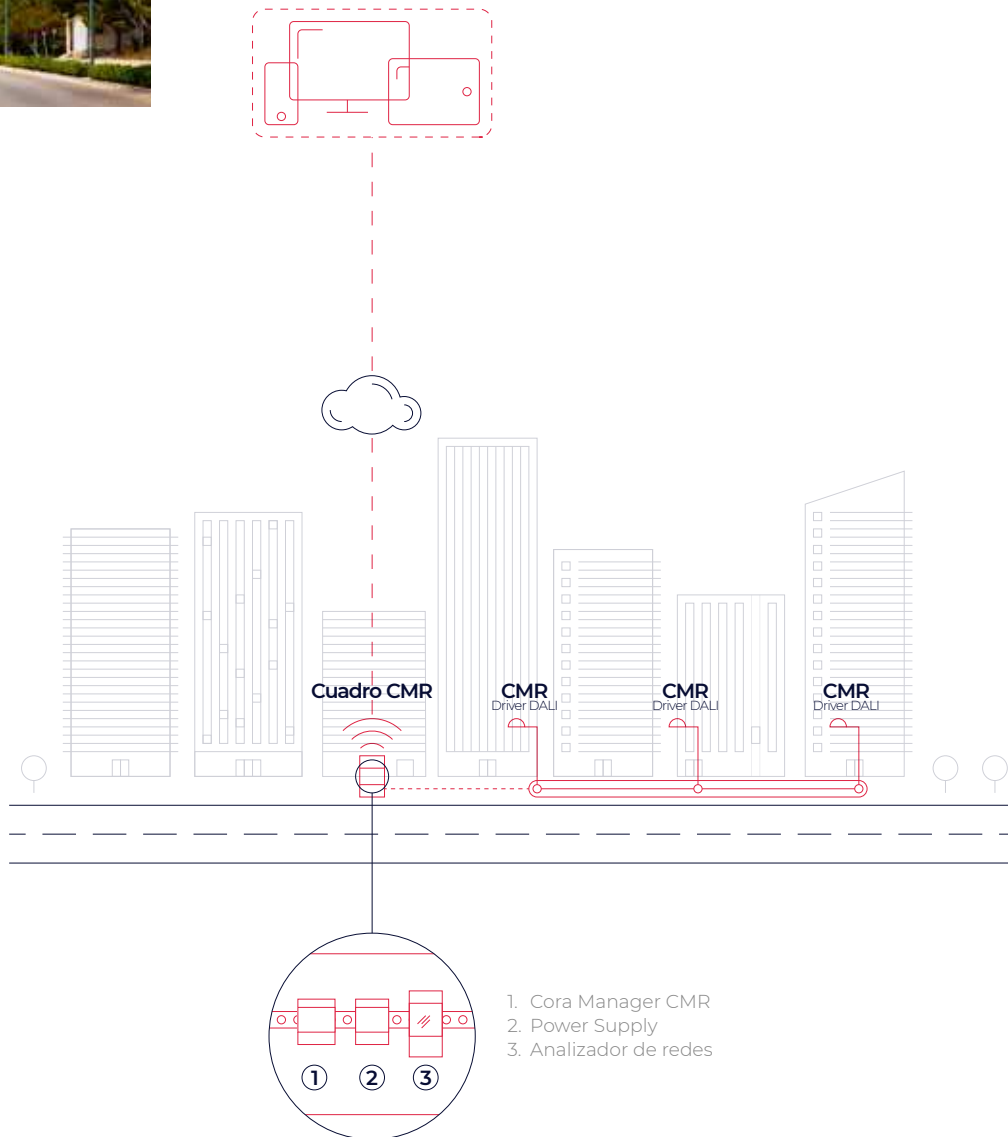

## Ñ

Gestión del alumbrado en el cuadro eléctrico que permite el control por grupos de las luminarias conectadas al centro de mando mediante la línea de alimentación (CMR) sin cableado adicional.

## F

Gestion de l'éclairage dans le tableau électrique qui permet le contrôle groupé des luminaires connectés au centre de contrôle via la ligne électrique (CMR) sans câblage supplémentaire.

## E

Lighting management in the electrical panel that allows group control of the luminaires connected to the control center via the power line (CMR) without additional wiring.

## P

Gestão da iluminação no quadro elétrico que permite o controlo em grupo das luminárias ligadas ao centro de controlo através da linha de alimentação (CMR) sem cablagem adicional.

# Cora Manager PLC

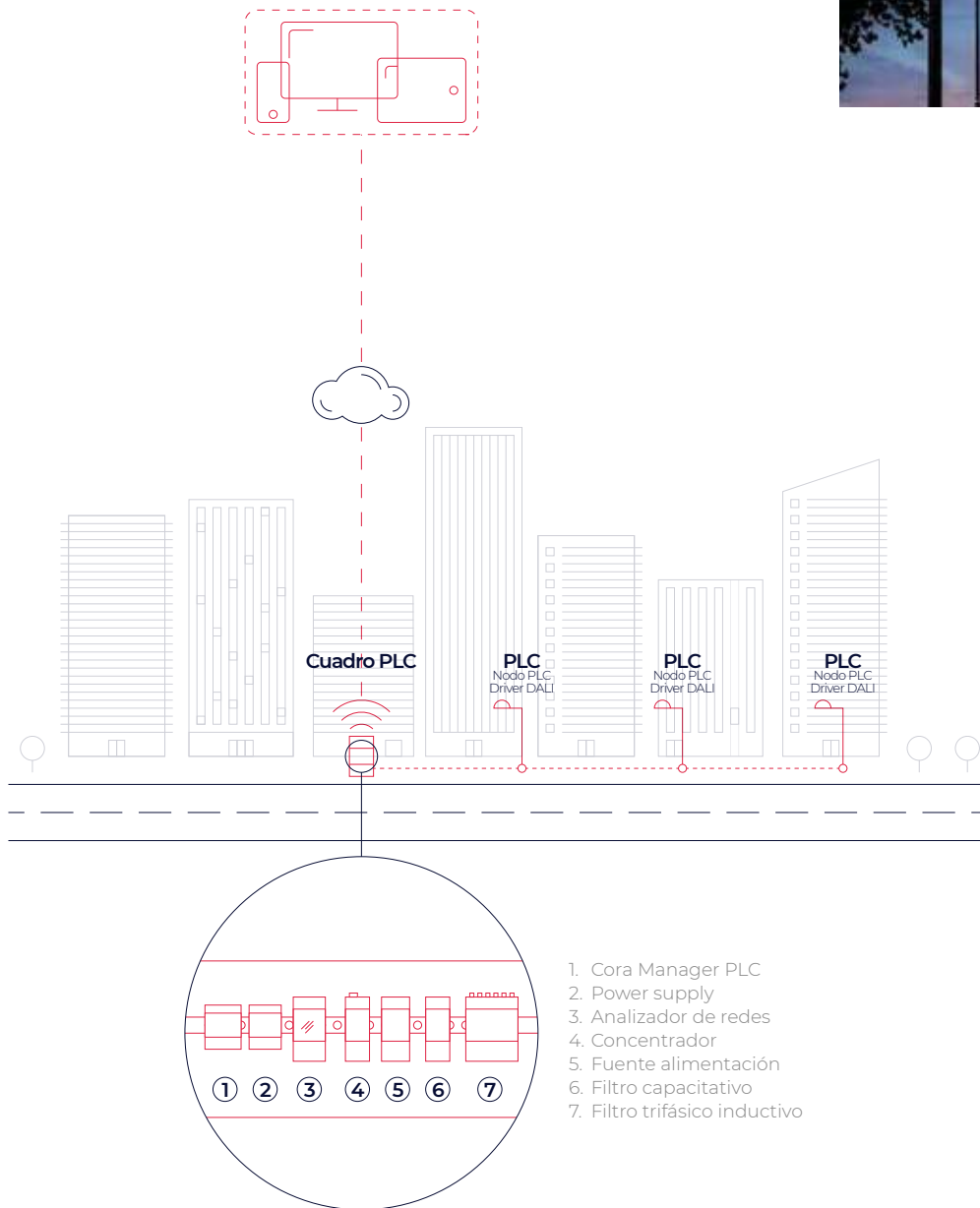

## Ñ

Gestión del alumbrado punto a punto desde la plataforma UNIO gracias a la comunicación bidireccional mediante la propia línea de alimentación con las luminarias al enviar datos a la nube mediante 2G/4G/NB-IoT.

## F

Gestion de l'éclairage point à point depuis la plate-forme UNIO grâce à la communication bidirectionnelle via la ligne électrique elle-même avec les luminaires lors de l'envoi de données vers le cloud via 2G/4G/NB-IoT.

## E

Point-to-point lighting management from the UNIO platform thanks to bidirectional communication through the power line itself with the luminaires when sending data to the cloud via 2G/4G/NB-IoT.

## P

Gerenciamento de iluminação ponto a ponto a partir da plataforma UNIO graças à comunicação bidireccional através da própria linha de energia com as luminárias ao enviar dados para a nuvem via 2G/4G/NB-IoT.

# Cora Manager IoT

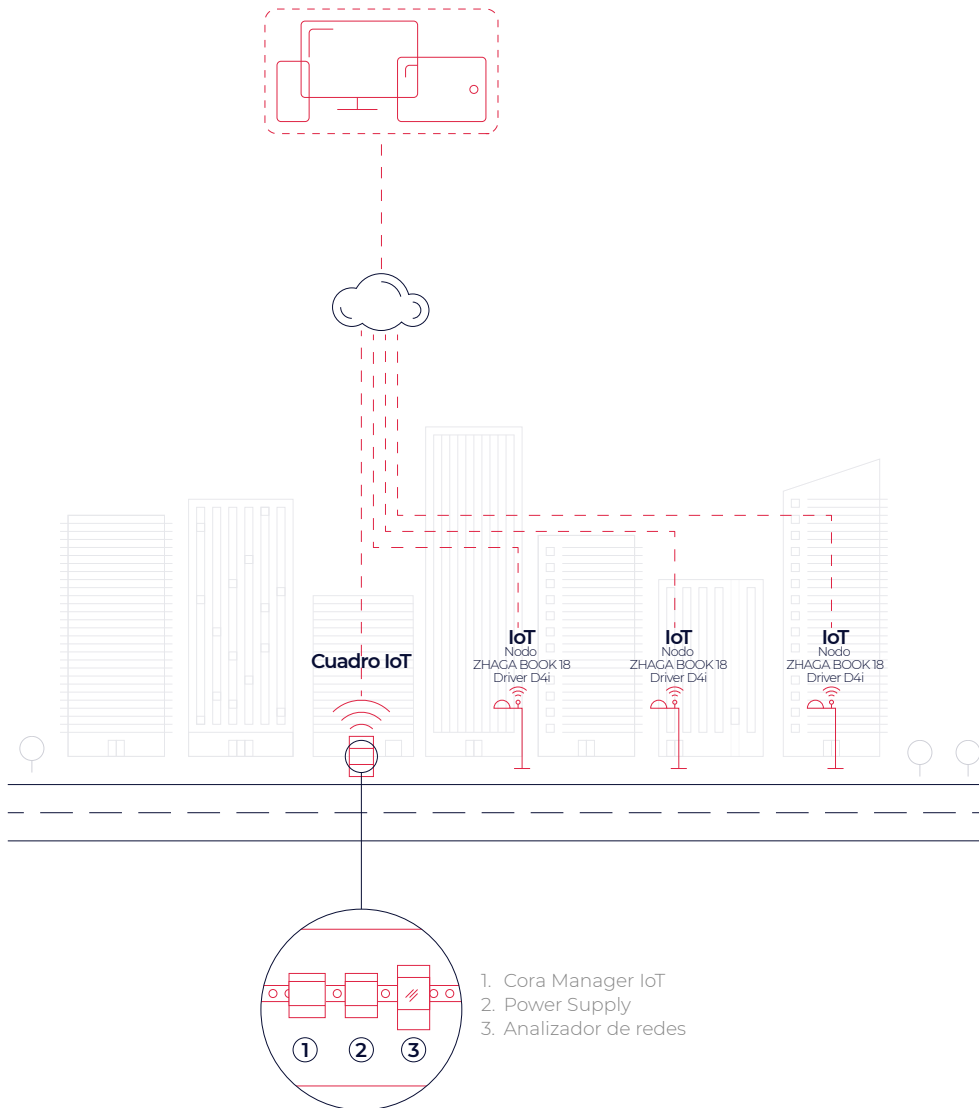

## Ñ

Gestión remota del alumbrado punto a punto a través de la red móvil IoT sin necesidad de elementos de comunicación auxiliares en el cuadro eléctrico.

## F

Gestion à distance de l'éclairage point à point via le réseau mobile IoT sans avoir besoin d'éléments de communication auxiliaires dans le panneau électrique.

## E

Remote management of point-to-point lighting through the IoT mobile network without the need for auxiliary communication elements in the electrical panel.

## P

Gestão remota da iluminação ponto-a-ponto através da rede móvel IoT sem necessidade de elementos auxiliares de comunicação no quadro elétrico.

# Luminarias compatibles

Compatible luminaires / Luminaires compatibles / Luminárias compatíveis

Arisa Top 1

C P I



Arisa Top 2

C P I



Arisa Top 4

C P I



Arisa Road

C P I



Arisa Catenaria

C P I



Veria

C P I



Versa

C P I



Versa L

C P I



Versa XL

C P I



Avatar

C P I



Avatar L

C P I



Avatar XL

C P I





Sfera



Netta



Livia



Ircana



Gaudium



Grupo óptico



## IoT

Luminarias compatibles con con conectores NEMA 7 según ANSI C136.41-2013 y ZHAGA-D4i :

Luminaire compatible with NEMA 7 according to ANSI C136.41-2013 and ZHAGA-D4i connectors:

Luminaire compatible avec les connecteurs NEMA 7 selon ANSI C136.41-2013 et ZHAGA-D4i:

Luminárias compatíveis com conectores NEMA 7 de acordo com ANSI C136.41-2013 e ZHAGA-D4i:

ARISA, AVATAR, VERIA, VERSA, NANTES y HEXAGON (No incluidas: ESENCIAL, ZENIT, RGBW)

NEMA 7



ZHAGA-D4i



CMR



PLC



IoT

# Multipotencia

Multipotence

Multipotence

Multipotência



## Ñ

Las nuevas luminarias multipotencia de Prilux son la solución más versátil de iluminación vial ya que pueden ser programadas hasta cuatro potencias y un sinfín de perfiles de programación. Se sirven de fábrica con máxima potencia y perfil 0 pudiendo reprogramarse posteriormente según las necesidades del usuario. Para ello es necesario el uso combinado de una única antena con tecnología NFC y una app instalada en un dispositivo móvil.

Las luminarias multipotencia prilux también disponen de tecnología CMR por lo que es posible configurar los perfiles de programación a través del cuadro del que cuelgan las luminarias utilizando nuestros dispositivos cora manager.

## F

Les nouveaux luminaires multi-puissance de Prilux sont la solution d'éclairage routier la plus polyvalente, car jusqu'à quatre puissances et des profils de programmation sans fin peuvent être programmés. Ils sont servis en usine avec une puissance maximale et un profil 0 et peuvent être reprogrammés plus tard selon les besoins de l'utilisateur. Cela nécessite l'utilisation combinée d'une seule antenne avec la technologie NFC et d'une application installée sur un appareil mobile.

Les luminaires multi-puissance Prilux disposent également de la technologie CMR, il est donc possible de configurer les profils de programmation via le panneau sur lequel les luminaires sont suspendus à l'aide de nos dispositifs cora manager.

## E

Prilux's new multi-power luminaires are the most versatile road lighting solution since up to four powers and endless programming profiles can be programmed. They are served at the factory with maximum power and profile 0 and can be reprogrammed later according to the user's needs. This requires the combined use of a single antenna with NFC technology and an app installed on a mobile device.

Prilux multi-power luminaires also have CMR technology, so it is possible to configure the programming profiles through the panel on which the luminaires hang using our cora manager devices.

## P

As novas luminárias multipotentes da Prilux são a solução de iluminação viária mais versátil, pois é possível programar até quatro potências e perfis de programação infinitos. Eles são atendidos na fábrica com potência máxima e perfil 0 e podem ser reprogramados posteriormente, de acordo com as necessidades do usuário. Isso requer o uso combinado de uma única antena com a tecnologia NFC e um aplicativo instalado em um dispositivo móvel.

As luminárias de potência múltipla Prilux também possuem tecnologia CMR, portanto, é possível configurar os perfis de programação através do painel no qual as luminárias ficam penduradas usando nossos dispositivos cora manager.



# Funcionalidades

## Functionalities / Fonctionnalités / Funcionalidades

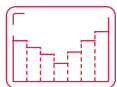

### Gestión autónoma de programación de potencias y perfiles.

Autonomous management of powers and profiles programming.  
Gestion autonome de la programmation des puissances et des profils.  
Gerenciamento autônomo de programação de potências e perfis.



### Configuración flexible a través de NFC.

Flexible configuration through NFC.  
Configuration flexible via NFC.  
Configuração flexível através de NFC.

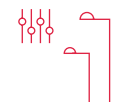

### Adaptable a las necesidades del mercado o de tus clientes.

Adaptable to the needs of the market or your customers.  
Adaptable aux besoins du marché ou de vos clients.  
Adaptável às necessidades do mercado ou de seus clientes.



### Luminarias preparadas para cualquier cambio que pueda surgir en el futuro.

Luminaires ready for any changes that may arise in the future.  
Des luminaires prêts pour tous les changements qui pourraient survenir à l'avenir.  
Luminárias prontas para quaisquer alterações que possam surgir no futuro.



### Facilidad para reposición de drivers fallidos.

Ease of replacement of failed drivers.  
Facilité de remplacement des pilotes défectueux.  
Facilidade de substituição de drivers com falha.



### Luminarias de alumbrado público dinámicas, versátiles, flexibles y adaptadas a las necesidades del momento.

Dynamic street lighting luminaires, versatile, flexible and adapted to the needs of the moment.  
Luminaires d'éclairage public dynamiques, polyvalents, flexibles et adaptés aux besoins du moment.  
Luminárias dinâmicas para iluminação pública, versáteis, flexíveis e adaptadas às necessidades do momento.



# Luminarias compatibles

Compatible luminaires / Luminaires compatibles / Luminárias compatíveis

Versa



Veria



Avatar



Grupo Óptico

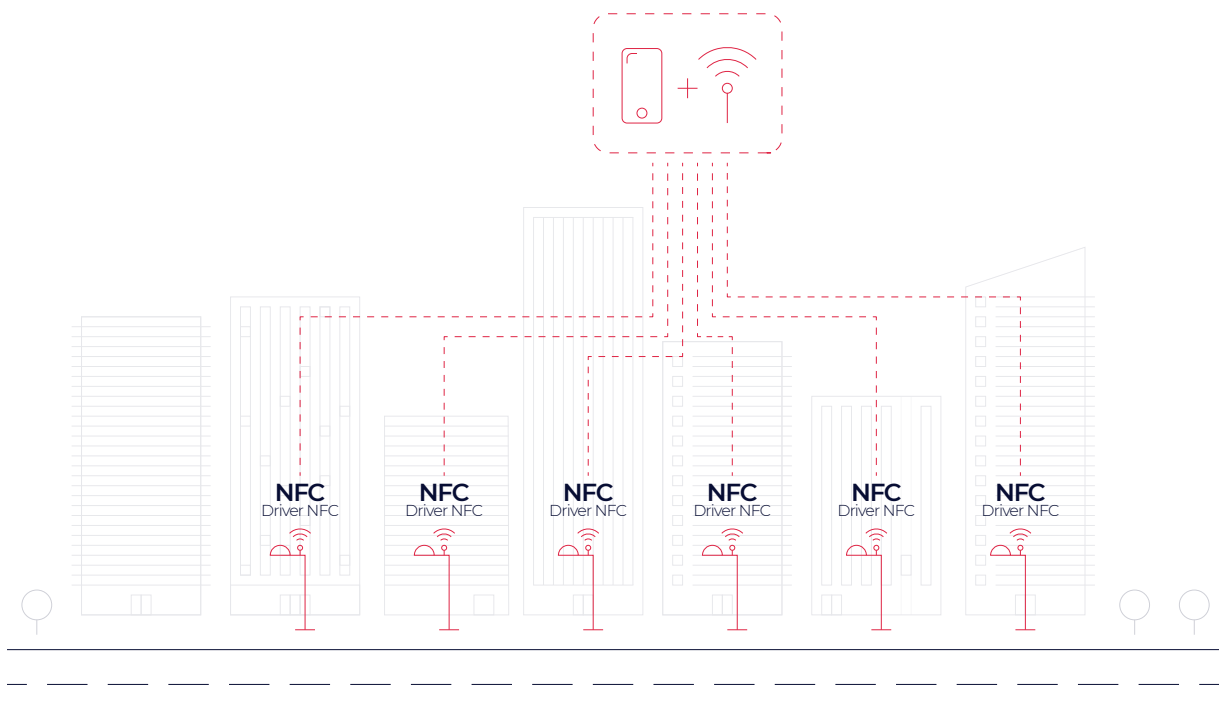

# SAFELIGHT

Solución para pasos de cebra

Optical Solution Zebra Crossing

Solution de passage piéton

Solução de faixa de pedestres



## Ñ

Según los estudios, un alto porcentaje de los atropellos que tienen lugar en vías urbanas se produce en los pasos de cebra no señalizados con semáforos y con una iluminación inadecuada o inexistente lo que conlleva a una escasa y deficiente visibilidad de los peatones en la zona de paso de la vía.

Para evitar esto Prilux ha desarrollado SAFELIGHT una solución de tres modalidades, donde a través de una adecuada iluminación, se consigue captar la atención del conductor, reduciendo además el riesgo de deslumbramiento, acentuando la iluminación en el entorno del paso de cebra incrementando por un lado el nivel de luz en la zona de la acera que accede al paso de cebra y por otro, aumentando la iluminación sobre el peatón.

## F

Selon les études, un pourcentage élevé des abus qui ont lieu sur les routes urbaines se produisent dans des passages piétons non marqués de feux de circulation et avec un éclairage inadéquat ou inexistant, ce qui conduit à une mauvaise et mauvaise visibilité des piétons dans la zone de passage de la piste.

Pour éviter cela, Prilux a développé SAFELIGHT une solution, de trois modalités, grâce à un éclairage adapté, on arrive à capter l'attention du conducteur, réduisant également le risque d'éblouissement, en accentuant l'éclairage de l'environnement du passage piétons en augmentant d'une part le niveau de lumière dans la zone du trottoir qui donne accès au passage piétons et d'autre part, en augmentant l'éclairage sur le piéton.

## E

According to the studies, a high percentage of the abuses that take place in urban roads occur in zebra crossings not marked with traffic lights and with inadequate or non-existent lighting which leads to poor and poor visibility of pedestrians in the area of passage of the track.

To prevent this, Prilux has developed SAFELIGHT, a solution of three modalities, a solution that uses proper lighting to attract drivers' attention, also reducing the risk of glare, around zebra crossings, thus increasing not only the amount of lighting around pedestrians as they approach zebra crossings, but also intensifying the lighting on them both vertically and horizontally.

## P

Segundo estudos, uma alta porcentagem dos abusos ocorridos nas estradas urbanas ocorre em cruzamentos de zebra não marcados com semáforos e com iluminação inadequada ou inexistente, o que leva a uma baixa e baixa visibilidade dos pedestres na área de passagem da pista.

Para evitar isso Prilux desenvolveu SAFELIGHT, uma solução, de três modalidades onde através de iluminação adequada, consegue capturar a atenção do motorista, reduzindo também o risco de ofuscamento acentuando iluminação no cruzamento ambiente zebra levantando um lado o nível de luz na área da calçada acessando o passeadeira e, por outro, aumentar a iluminação do pedestre.



# Safelight / Sensor Safelight



Safelight

**SAFELIGHT** permite la iluminación de pasos de cebra con luminarias viales adaptadas con ópticas especiales para esta aplicación que iluminan con luz blanca con un nivel continuo del 100%.

SAFELIGHT allows the lighting of zebra crossings with road luminaires adapted with special optics for this application that illuminate with white light with a continuous level of 100%.

SAFELIGHT permet l'éclairage de passages piétons avec des luminaires adaptés avec des optiques spéciales pour cette application qui éclairent avec une lumière blanche avec un niveau continu de 100%.

SAFELIGHT permite a iluminação de passadeiras com luzes rodoviárias adaptadas com óticas especiais para esta aplicação que iluminam com luz branca a um nível contínuo de 100%.



Sensor Safelight

**SENSOR SAFELIGHT**, provisto de un sensor de presencia orientado hacia la acera, mantiene la iluminación del paso de peatones a un nivel de luminosidad del 50% en ausencia de usuarios, regulando al 100% en el momento en que el sensor detecte la presencia de algún peatón dispuesto a cruzar por el paso de cebra. Lo que proporciona un gran ahorro energético y económico.

SENSOR SAFELIGHT is equipped with a presence sensor facing the sidewalk, maintains the illumination of the crosswalk at a brightness level of 50% in the absence of users, regulating 100% at the time the sensor detects the presence of a pedestrian willing to cross the zebra crossing. Which provides great energy and economic savings.

SENSOR SAFELIGHT, équipé d'un capteur de présence orienté vers le trottoir, maintient l'éclairage du passage clouté à un niveau de luminosité de 50% en l'absence de piétons, passant à 100% lorsque le capteur détecte la présence d'un piéton prêt à traverser le passage clouté. Ce qui offre de grandes économies d'énergie et économiques.

SENSOR SAFELIGHT, equipado com um sensor de presença voltado para a calçada, mantém a iluminação da faixa de pedestres em um nível de luminosidade de 50% na ausência de usuários, diminuindo para 100% quando o sensor detecta a presença de um pedestre disposto a atravessar a passadeira. O que proporciona grande economia de energia e economia.



Sin Presencia  
No Presence  
Pas de Présence  
Sem Presença



Con Presencia  
With Presence  
Avec Présence  
Com Presença

	CTT	Nivel de luminosidad Luminosity level Niveau de luminosité Nível de brilho	Nivel de luminosidad Luminosity level Niveau de luminosité Nível de brilho
Safelight	4.000K	100%	100%
Sensor Safelight	4.000K	50%	100%



# Luminarias compatibles

Compatible luminaires / Luminaires compatibles / Luminárias compatíveis

Avatar



Veria



Arisa Top 1



Arisa Road



Barcode	Model	W <sub>LED</sub>	W <sub>T</sub>	Beam	K	Light	Dimensions
589727	VERIA SL 8N DA CMR	32W	34,3W	PPDL0M	740	32	620 x 295 x 165mm
589734	VERIA SL 8N DA CMR	32W	34,3W	PPIL0M	740	32	620 x 295 x 165mm
589512	VERIA SL SENSOR	32W	34,3W	PPDL0M	740	32	620 x 295 x 165mm
589529	VERIA SL SENSOR	32W	34,3W	PPIL0M	740	32	620 x 295 x 165mm
589673	AVATAR SL 8N DA CMR	36W	37,0W	PPDL0M	740	24	525 x 255 x 125mm
589680	AVATAR SL 8N DA CMR	36W	37,0W	PPIL0M	740	24	525 x 255 x 125mm
589697	AVATAR SL SENSOR	36W	37,0W	PPDL0M	740	24	525 x 255 x 125mm
589703	AVATAR SL SENSOR	36W	37,0W	PPIL0M	740	24	525 x 255 x 125mm
589772	ARISA ROAD SL 8N DA CM	32W	34,3W	PPDL0M	740	32	670 x 468 x 140mm
589789	ARISA ROAD SL 8N DA CM	32W	34,3W	PPIL0M	740	32	670 x 468 x 140mm
589796	ARISA ROAD SL SENSOR	32W	34,3W	PPDL0M	740	32	670 x 468 x 140mm
589802	ARISA ROAD SL SENSOR	32W	34,3W	PPIL0M	740	32	670 x 468 x 140mm
589819	ARISA TOP1 SL 8N DA CM	32W	34,3W	PPDL0M	740	32	478 x 468 x 547mm
589826	ARISA TOP1 SL 8N DA CM	32W	34,3W	PPIL0M	740	32	478 x 468 x 547mm
589833	ARISA TOP1 SL SENSOR	32W	34,3W	PPDL0M	740	32	478 x 468 x 547mm
589840	ARISA TOP1 SL SENSOR	32W	34,3W	PPIL0M	740	32	478 x 468 x 547mm

# WAS outdoor

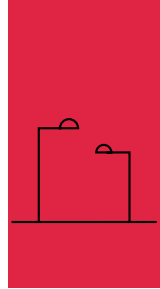

## Ñ

PRILUX ha desarrollado la solución WAS OUTDOOR que adapta la iluminación de calles, parques, avenidas...mediante el cambio de la temperatura de color y nivel adecuandola a las franjas horarias nocturnas y sus diferentes niveles de tráfico rodado y tránsito de viandantes. El uso de WAS OUTDOOR mejora las condiciones de visibilidad a la vez que se obtiene un ahorro económico y energético. Además no se influye negativamente en el normal desarrollo de los ciclos vitales del ser humano y la fauna urbana.

Las luminarias WAS OUTDOOR funcionan de manera autónoma y disponen de un perfil preprogramado de 5 escalones que permite el cambio gradual en la temperatura de color; de fría (4.000K) a cálida (PC AMBAR) y de nivel (de 100% a 50%) y viceversa adaptando su nivel de luminosidad a las distintas fases de la noche según la actividad que tenga lugar, en la ciudad, en esa franja horaria.

## F

PRILUX a développé la solution WAS OUTDOOR qui adapte l'éclairage des rues, des parcs, des avenues ... en modifiant la couleur et le niveau de température en l'adaptant aux plages horaires nocturnes et à leurs différents niveaux de circulation routière et piétonne. L'utilisation de WAS OUTDOOR améliore les conditions de visibilité tout en réalisant des économies économiques et énergétiques. De plus, le développement normal des cycles de vie des êtres humains et de la faune urbaine n'est pas influencé négativement.

Les luminaires équipés WAS OUTDOOR fonctionnent de forme autonome et disposent d'un profil préprogrammé de 5 paliers qui permet le changement progressif au niveau de la température de couleur ; de froid (4000 K) à chaud (PC AMBAR) et de niveau (de 100 % à 50 %) et vice-versa, adapté à leur niveau de luminosité lors des différentes phases de la nuit, en fonction de l'activité qui a lieu dans la ville lors de cette tranche horaire

## E

PRILUX has developed the WAS OUTDOOR solution that adapts the lighting of streets, parks, avenues ... by changing the color and level temperature adapting it to the night time slots and their different levels of road traffic and pedestrian traffic. The use of WAS OUTDOOR improves visibility conditions while achieving economic and energy savings. In addition, the normal development of life cycles of human beings and urban fauna is not negatively influenced.

The luminaires WAS OUTDOOR work in an autonomous way and have a pre-set profile of 5 steps which allows a progressive change in the colour temperature, from cold (4.000k) to warm (PC AMBAR), and of level (from 100% to 50%) and vice versa, adapting its level of brightness to the different stages of the night, depending on the activity taking place in the city at that time slot.

## P

A PRILUX desenvolveu a solução WAS OUTDOOR que adapta a iluminação de ruas, parques, avenidas ... alterando a cor e a temperatura nivelada, adaptando-a às faixas horárias noturnas e aos seus diferentes níveis de tráfego rodoviário e pedonal. O uso do WAS OUTDOOR melhora as condições de visibilidade e, ao mesmo tempo, economiza energia e economia. Além disso, o desenvolvimento normal dos ciclos de vida dos seres humanos e da fauna urbana não é influenciado negativamente.

As luminárias com WAS OUTDOOR funcionam de modo autónomo e dispõem de um perfil pré-programado de 5 escalões que permite a mudança gradual da temperatura de cor; de fria (4.000K) a quente (PC AMBAR) e de nível (de 100% a 50%) e vice-versa adaptando o seu nível de luminosidade às distintas fases da noite segundo a actividade que tenha lugar, na cidade, naquela faixa horária.



# Funcionalidades

## Functionalities / Fonctionnalités / Funcionalidades

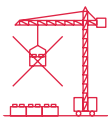

### Sin obras

No job needed  
Sans travaux  
Sem obras

No requiere cambios, ni adaptaciones de ningún tipo en la instalación existente.

It doesn't require changes or adaptations of any kind in the former installation.

Aucun changement ou aucune adaptation de quelque type que ce soit ne sont nécessaires au niveau de l'installation existante.

Não requer mudanças, nem adaptações de nenhum tipo na instalação existente.



### Otras Configuraciones

Other settings  
Autres configurations  
Outras configurações.

La solución WAS OUTDOOR de PRILUX dispone de otras temperaturas de color y permite la configuración de otros perfiles de regulación horario para el cambio de CCT y nivel, todo ello bajo pedido.

PRILUX's WAS OUTDOOR solution offers different colour temperatures and allows the setting of different profiles of time adjustment for the change of CCTs and levels, all of this upon request.

La solution WAS OUTDOOR de PRILUX dispose d'autres températures de couleur et permet la configuration d'autres profils de régulation horaire pour le changement de CCT et de niveau, tout ceci sur demande.

A solução WAS OUTDOOR da PRILUX dispõe de outras temperaturas de cor e permite a configuração de outros perfis de regulação horária para a mudança de CCT e nível, tudo a pedido.



### Listo para usar

Ready for use  
Prêt à l'utilisation  
Pronto para usar

Nuestras luminarias WAS OUTDOOR se sirven con manguera y conector de 5 polos que permite una fácil instalación.

Our WAS OUTDOOR luminaires are equipped with a hose and a 5-pole connector which allows an easy mounting.

Nos luminaires WAS OUTDOOR sont fournis avec un câble et un connecteur à 5 pôles, qui permet une installation facile.

As nossas luminárias WAS OUTDOOR servem-se com cabo e ligadores de 5 polos que permite uma fácil instalação.



### Desde el minuto 1

From the very first minute  
Depuis la 1ère minute  
Desde o minuto

Las luminarias WAS OUTDOOR funcionan de manera autónoma, regulando CCT o nivel de luminosidad desde el primer encendido. Otras luminarias necesitan hasta tres días de aprendizaje.

The WAS OUTDOOR luminaires work in an autonomous way, adjusting CCT or the level of brightness from the moment they are activated. Other luminaires need up to three days of learning.

Les luminaires WAS OUTDOOR fonctionnent de forme autonome, en réglant CCT ou le niveau de luminosité dès le premier allumage.

Les autres luminaires ont besoin de jusqu'à trois jours d'apprentissage

As luminárias WAS OUTDOOR funcionam de modo autónomo, regulando CCT ou em nível de luminosidade desde a primeira ligação. Outras luminárias necessitam até três dias de aprendizagem.



# Luminarias compatibles

Compatible luminaires / Luminaires compatibles / Luminárias compatíveis

Avatar



Veria



Ircana



Gaudium



Arisa Top 1



Arisa Top 2



Arisa Top 4



Arisa Road



Arisa Catenaria



## COMPATIBILIDAD / COMPATIBILITY / COMPATIBILITÉ / COMPATIBILIDADE



**Ñ:** La tecnología WAS (White Adaptive System) proporciona a las luminarias PRILUX la capacidad de cambiar tanto la cantidad de luz que proporcionan como la temperatura de color correlacionada, CCT.

**E:** The WAS (White Adaptive System) technology gives PRILUX luminaires the ability to change both the amount of light they provide and the correlated color temperature, CCT.

**F:** La technologie WAS (White Adaptive System) permet aux luminaires PRILUX de modifier à la fois la quantité de lumière qu'ils fournissent et la température de couleur corrélée, CCT, intrinsèques.

**P:** A tecnologia WAS (White Adaptive System) oferece às luminárias PRILUX a capacidade de alterar tanto a quantidade de luz que fornecem quanto a temperatura de cor correlacionada, CCT.





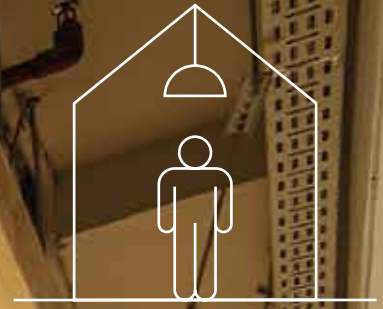

Soluciones de iluminación INTERIOR  
INDOOR lighting solutions  
Solutions d'éclairage INTÉRIEUR  
Soluções de iluminação INTERIOR



# WAS Indoor

## Solución White Adaptative System



### Ñ

La solución WAS INDOOR está especialmente orientada a hospitales, residencias geriátricas, centros de wellness, aulas, despachos en los que aumenta el bienestar del usuario. En centros de trabajo la iluminación circadiana se aplica para mejorar las condiciones visuales, la comodidad y el rendimiento de los trabajadores, lo que afecta de manera directa a su productividad, lo cual repercute de manera muy positiva al desarrollo de la empresa.

### F

La solution WAS INDOOR est destinée spécialement aux hôpitaux, résidences gériatriques, centres de bien-être, salles de cours, bureaux, où elle augmente le bien-être de l'utilisateur. Sur les lieux de travail, l'éclairage circadien est appliqué pour améliorer les conditions visuelles, le confort et le rendement des travailleurs, ce qui a un impact direct sur leur productivité et se répercute de forme très positive sur le développement de l'entreprise.

### E

The WAS INDOOR solution is specifically aimed at increasing the well-being of users in places such as hospitals, nursing homes, wellness centres, classrooms and offices. The circadian lighting is applied in workplaces to improve visual conditions, comfort and the workers' performance, resulting in a higher productivity and a better development of the company.

### P

A solução WAS INDOOR está especialmente orientada para hospitais, residências geriátricas, centros de bem estar, salas de aula, escritórios nos quais se incrementa o bem estar do utilizador. Nos centros de trabalho a iluminação circadiana aplica-se para melhorar as condições visuais, a comodidade e o rendimento dos trabalhadores, o que influencia de modo directo a sua produtividade, que se repercute de modo muito positivo no desenvolvimento da empresa.





# Funcionalidades

## Functionalities / Fonctionnalités / Funcionalidades



### Aumenta la motivación y mejora el estado de ánimo

Increases motivation and favours a better mood  
Il augmente la motivation et améliore l'humeur  
Aumenta a motivaçã o e melhora o estado de ânimo



### Mejora la productividad

Increases productivity  
Il améliore la productivité  
Melhora a produtividade



### Mejora la salud y bienestar

Improves health and well-being  
Il améliore la santé et le bien-être  
Melhora a saúde e o bem estar



### Reduce bajas y absentismo laboral

Reduces leaves and work absenteeism  
Il réduit les arrêts et l'absentéisme au travail.  
Reduz o numero de baixas e absentismo laboral

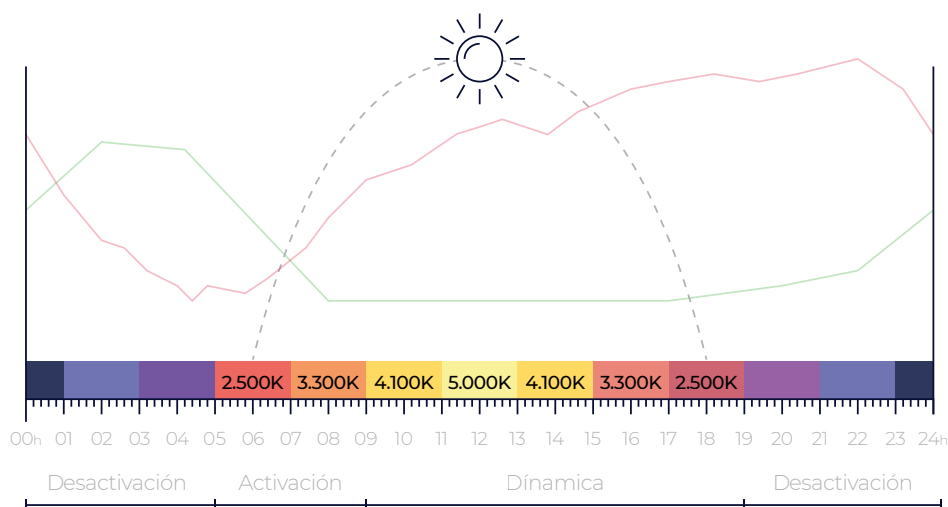

**Ñ:** Está demostrado que la luz del sol interviene en las funciones fisiológicas de los organismos, tanto la presencia de luz (día) como la ausencia de la misma (noche) producen variaciones periódicas físicas, mentales y conductuales durante las 24h del día y marcan los diferentes procesos metabólicos de los seres vivos: ciclos del sueño, periodos de alimentación y digestión, temperatura corporal, secreciones hormonales, etc.

**E:** The WAS INDOOR solution is specifically aimed at increasing the well-being of users in places such as hospitals, nursing homes, wellness centres, classrooms and offices. The circadian lighting is applied in workplaces to improve visual conditions, comfort and the workers' performance, resulting in a higher productivity and a better development of the company.

**F:** Il est démontré que la lumière du soleil intervient au niveau des fonctions physiologiques des organismes. Aussi bien la présence de lumière (jour) que l'absence de cette dernière (nuit) produisent des variations périodiques physiques, mentales et comportementales durant les 24 h de la journée et marquent les différents processus métaboliques des êtres vivants: cycle du sommeil, périodes d'alimentation et de digestion, température corporelle, sécrétions hormonales, etc.

**P:** Está demostrado que a luz do sol intervêm nas funções fisiológicas dos organismos, tanto na presença da luz (día) como na ausência da mesma (noite) produzem-se variações periódicas físicas, mentais e comportamentais durante as 24h do dia e marcam os diferentes processos metabólicos dos seres vivos: ciclos do sono, períodos de alimentação e digestão, temperatura corporal, secreções hormonais, etc.

# Luminarias compatibles

Compatible luminaires / Luminaires compatibles / Luminárias compatíveis

Stania



Lynx celosía especular



Lynx difusor PC opal



## COMPATIBILIDAD / COMPATIBILITY / COMPATIBILITÉ / COMPATIBILIDADE



**Ñ:** La tecnología WAS (White Adaptive System) proporciona a las luminarias PRILUX la capacidad de cambiar tanto la cantidad de luz que proporcionan como la temperatura de color correlacionada, CCT.

**E:** The WAS (White Adaptive System) technology gives PRILUX luminaires the ability to change both the amount of light they provide and the correlated color temperature, CCT.

**F:** La technologie WAS (White Adaptive System) permet aux luminaires PRILUX de modifier à la fois la quantité de lumière qu'ils fournissent et la température de couleur corrélée, CCT, intrinsèques.

**P:** A tecnologia WAS (White Adaptive System) oferece às luminárias PRILUX a capacidade de alterar tanto a quantidade de luz que fornecem quanto a temperatura de cor correlacionada, CCT.

# Pack CTE

Luz natural DALI

DALI Natural light

lumière naturelle DALI

Luz natural DALI

---



## Ñ

Regulación por aporte de luz natural para cumplir con las exigencias del CTE.

Control independiente de dos líneas de luminarias regulables DALI con sensor para instalar en luminaria o caja en superficie. Preconfigurado para poner en funcionamiento de manera sencilla.

## F

Régulation en fonction de l'apport de lumière naturelle, pour répondre aux exigences du code technique de la construction (CTC).

Contrôle indépendant de deux lignes de luminaires réglables DALI, avec capteur à installer sur luminaire ou dans un boîtier en surface. Préconfiguré pour être mis en service de forme simple.

## E

Dimming for natural light to comply with CTE requirements.

Separate control of the two DALI light lines with a sensor to install in the lights or in a box at floor level. Pre-configured to turn on easily.

## P

Regulação por entrada de luz natural para cumprir com as exigências do CTE.

Control independente de duas linhas de luminárias reguláveis DALI com sensor para instalar na luminária ou em caixa de superfície. Pré-configurado para poder colocar em serviço de modo facilitado.





VIALCO  
Villena (Alicante)

# Funcionalidades

## Functionalities / Fonctionnalités / Funcionalidades

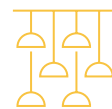

- Sistema de control digital DALI para control por presencia y regulación por aporte de luz natural. Control manual por pulsador (no hay límite de pulsadores en paralelo).
- Digital DALI control system for presence control adjustable based on the contribution of natural light. Manual control with a switch (with no limit on parallel switches).
- Système de contrôle numérique DALI pour le contrôle en fonction de la présence et la régulation conformément à l'apport de lumière naturelle. Contrôle manuel moyennant bouton (sans limite de boutons en parallèle).
- Sistema de control digital DALI para control por presença e regulação por entrada de luz natural. Control manual por botão de pressão (não há limites para botões de pressão em paralelo).



- Detección de presencia a través del multisensor incorporado.
- Presence detection with an integrated multi-sensor
- étection de présence grâce au multi-capteur incorporé.
- Detecção de presença através do multisensor incorporado.

- Múltiples opciones configurables: nivel secundario cuando no haya detección de presencia, desfase de niveles entre los dos grupos, apagado por exceso, actuación en caso de rearme, regulación manual, control independiente entre grupos control por mando IR a distancia...
- Multiple configurable options: secondary level if no presence detected, level offset between the two groups, turns off due to excess, turns on if rearmed, manual adjustment, separate control between control groups with remote IR control
- Múltiples options de configuration: niveau secondaire lorsque aucune présence n'est détectée, décalage de niveaux entre les deux groupes, extinction en raison d'un excès, action en cas de réarmement, régulation manuelle, contrôle indépendant entre groupes de contrôle par commande IR à distance...

- Múltiplas opções configuráveis: nível secundário quando não exista deteção de presença, desfasamento de níveis entre os dois grupos, desligar por excesso, acção em caso de rearme, regulação manual, control independente entre grupos control por comando IR a distância...

Luminosidad a través de multisensor con rango 10–500lx, orientado al plano de referencia y no a la entrada de luz.

Lighting from a multi-sensor with a range of 10–500lx focused on the reference plane and not on the entrance of the light.

Luminosité par l'intermédiaire de multi-capteur d'intervalle 10–500lx, orienté vers le plan de référence et non vers l'entrée de lumière.

Luminosidade através de multisensor com gama de 10–500lx, orientado para o plano de referência e não para a entrada de luz.

- Es posible conectar amplificadores DALI a la salida de control para ampliar en hasta 64 luminarias por amplificador y hasta 300m de longitud.

- DALI amplifiers can be connected to the control output to increase the light up to 64 lumen with an amplifier and up to a length of 300m.

- Il est possible de connecter des amplificateurs DALI à la sortie de contrôle pour élargir jusqu'à 64 luminaires par amplificateur et jusqu'à 300m de longueur.

- É possível ligar amplificadores DALI à saída de control para ampliar até 64 luminárias por amplificador e até 300m de comprimento.

NOTA / NOTE:  
Conectar amplificadores implica que un gran número de luminarias actuarán de la misma manera, con la misma medición de aporte de luz natural, y esto, normalmente, no es la manera de regular más eficiente ni la más precisa. Conectar amplifiers means that a large number of lights will act in the same way, with the same measurement of additional natural light, and this is usually not the most efficient or appropriate method. Connecter des amplificateurs implique qu'un grand nombre de luminaires fonctionne de la même manière, avec la même mesure d'apport de lumière naturelle, et ceci n'est pas normalement la forme de régulation la plus efficace et la plus précise. Ligar amplificadores implica que um grande número de luminárias actuarão da mesma maneira, com a mesma medição de entrada de luz natural, e isto, normalmente, não é a maneira de regular mais eficiente nem a mais precisa.

# Luminarias compatibles

Compatible luminaires / Luminaires compatibles / Luminárias compatíveis

Lynx Led Superficie \*



Lynx Led Line Superficie \*



Lynx Led Empotrar \*



Lynx Led Line Empotrar \*



Lynx Led Pared \*



Stania\*



Silent Led V IP65 \*

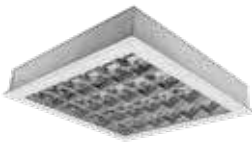

Kobe \*



Kobe Switch \*



Tribola \*



Ebro Led \*



Miño Led \*



\* Bajo pedido  
On request  
Sur commande  
A pedido

AVISO / WARNING / AVERTISSEMENT / AVISO



Las soluciones Pack CTE son de aplicación exclusivas en luminarias provistas de sistema DALI.

CTE Pack solutions apply exclusively to luminaires equipped with a DALI system.

Les solutions CTC appliquent exclusivement aux luminaires équipés d'un système DALI.

As soluções da Pack CTE aplicam-se exclusivamente a luminárias equipadas com um sistema DALI.

# Pack Aula/Despachos

Classroom/Offices Pack

Pack Salle de Cours/Bureau

Pack Sala de Aula/Esritórios



## Ñ

Regulación por aporte de luz natural y presencia stand alone.

Sistema de control de iluminación para cumplir con las exigencias del CTE y optimizar el uso de la energía aprovechando el aporte de luz natural y apagado automático en caso de ausencia.

Control independiente de dos líneas de luminarias regulables DALI y una tercera línea ON-OFF.

## F

Réglage en fonction de l'apport de lumière naturelle et de la présence stand alone.

Système de contrôle de l'éclairage pour répondre aux exigences du code technique de la construction (CTC) et optimiser l'utilisation de l'énergie en profitant de l'apport de lumière naturelle et de l'extinction automatique en cas d'absence.

Contrôle indépendant de deux lignes de luminaires réglables DALI et d'une troisième ligne ON-OFF.

## E

Dimming for addition of natural light and standalone presence.

A system to control lighting to meet CTE requirements and optimise energy use by taking advantage of natural light and automatic shut-off in the case of absence.

Independent control of two adjustable DALI lighting lines and a third on/off line.

## P

Regulação por entrada de luz natural e presença "stand alone".

Sistema de control de iluminação para cumprir com as exigências do CTE e otimizar o uso da energia aproveitando a entrada de luz natural e desligar automaticamente em caso de ausência.

Control independente de duas linhas de luminárias reguláveis DALI e uma terceira linha ON-OFF.





# Funcionalidades

## Functionalities / Fonctionnalités / Funcionalidades



Sistema de control digital DALI para control por presencia y regulación por aporte de luz natural.

Digital DALI control system for presence control adjustable based on the contribution of natural light

Système de contrôle numérique DALI pour le contrôle en fonction de la présence et le réglage conformément à l'apport de lumière naturelle.

Sistema de control digital DALI para control por presença e regulação por entrada de luz natural.



Funcionamiento automático y control manual por pulsador (Sin limite de pulsadores en paralelo).

Automatic on/off and manual control with a switch (with no limit on parallel switches).

Fonctionnement automatique et contrôle manuel moyennant bouton (sans limite de boutons en parallèle).

Funcionamento automático e control manual por botão de pressão (Sem limite de botoões de pressão em paralelo).



Detección de presencia a través del multisensor incorporado.

Presence detection with an integrated multi-sensor

détection de présence grâce au multi-capteur incorporé.

Detecção de presença através do multisensor incorporado.



Luminosidad a través de multisensor con rango 10–650lx, orientado al plano de referencia y no a la entrada de luz.

Lighting from a multi-sensor with a range of 10–650lx focused on the reference plane and not on the entrance of the light.

Luminosité par l'intermédiaire de multi-capteur d'intervalle 10–650 lx, orienté vers le plan de référence et non vers l'entrée de lumière.

Luminosidade através de multisensor com gama de 10–650lx, orientado para o plano de referência e não para a entrada de luz.



- Múltiples opciones configurables:
  - Nivel secundario cuando no haya detección de presencia
  - Desfase de niveles entre los dos grupos,
  - Apagado por exceso
  - Actuación en caso de rearme.
  - Regulación manual
  - Control independiente entre grupos control por mando IR a distancia...
- Multiple configurable options:
  - Secondary level if no presence detected
  - Level offset between the two groups
  - Turns off due to excess
  - Turns on if rearmed.
  - Manual adjustment
  - Separate control between control groups with remote IR control...

- Multiples options de configuration:
  - Niveau secondaire lors que aucune présence n'est détectée.
  - Décalage de niveaux entre les deux groupes.
  - Extinction en raison d'un excès.
  - Action en cas de réarmement.
  - Régulation manuelle
  - Contrôle indépendant entre groupes de contrôle par commande IR à distance...
- Múltiplas opções configuráveis:
  - Nivel secundário quando não exista deteção de presença
  - Desfasamento de nível entre os dois grupos,
  - Desligado por excesso
  - Actuação no caso de rearme.
  - Regulação manual
  - Control independente entre grupos de control por comando IR à distância...

# Luminarias compatibles

Compatible luminaires / Luminaires compatibles / Luminárias compatíveis

Lynx Led Superficie \*



Lynx Led Line Superficie \*



Lynx Led Empotrar \*



Lynx Led Line Empotrar \*



Lynx Led Pared \*



Stania\*



Silent Led V IP65 \*



Kobe \*



Kobe Switch \*



Tribola \*



Ebro Led \*



Miño Led \*



\* Bajo pedido  
On request  
Sur commande  
A pedido

AVISO / WARNING / AVERTISSEMENT / AVISO



Las soluciones Pack Aula / Depachos son de aplicación exclusivas en luminarias provistas de sistema DALI.  
Classroom/Offices Pack solutions apply exclusively to luminaires equipped with a DALI system.

Les solutions Pack Salle de Cours/Bureau appliquent exclusivement aux luminaires équipés d'un système DALI.

As soluções da Pack Sala de Aula/Escritórios aplicam-se exclusivamente a luminárias equipadas com um sistema DALI.

# Versión BLUETOOTH

## BLUETOOTH pack



# CASAMBI

### Ñ

Versión de nuestras luminarias con comunicación Bluetooth Casambi que a través de cualquier terminal Bluetooth® vía APP gratuita nos ofrece el control de regulación de flujo, color, configuración de escenas, comportamiento vinculado a horarios. Múltiples accesorios pueden configurarse para funcionar en la misma red para unificar el control de uno o varios espacios, siendo posible crear grupos, escenas y secuencias dinámicas a medida. El dispositivo Bluetooth® es válido para cualquier luminaria DALI.

### F

Version de nos luminaires avec communication Bluetooth Casambi qui via n'importe quel terminal Bluetooth® via APP gratuite qui offre le contrôle de la régulation de flux, la couleur, la configuration de la scène, le comportement lié aux horaires. Plusieurs accessoires peuvent être configurés pour travailler sur le même réseau pour unifier le contrôle d'un ou plusieurs espaces, être capable de créer des groupes, des scènes et des séquences dynamiques à mesurer. L'appareil Bluetooth® est valable pour tout luminaire DALI.

### E

Casambi version of our fixtures that enables through any Bluetooth® terminal via free APP that offers the control of flow regulation, color, scene configuration, behavior linked to schedules. Multiple accessories can be configured to work on the same network to unify the control of one or more spaces, being able to create groups, scenes and dynamic sequences to measure. The Bluetooth® device is valid for any DALI luminaire.

### P

Versão das nossas luminárias com comunicação Bluetooth Casambi que através de qualquer terminal Bluetooth...® via aplicativo gratuito que oferece o controle de regulação de fluxo, cor, configuração de cena, comportamento vinculado a agendas. Vários acessórios podem ser configurados para trabalhar na mesma rede para unificar o controle de um ou mais espaços, podendo criar grupos, cenas e sequências dinâmicas para medir. O dispositivo Bluetooth® é válido para qualquer luminária DALI.



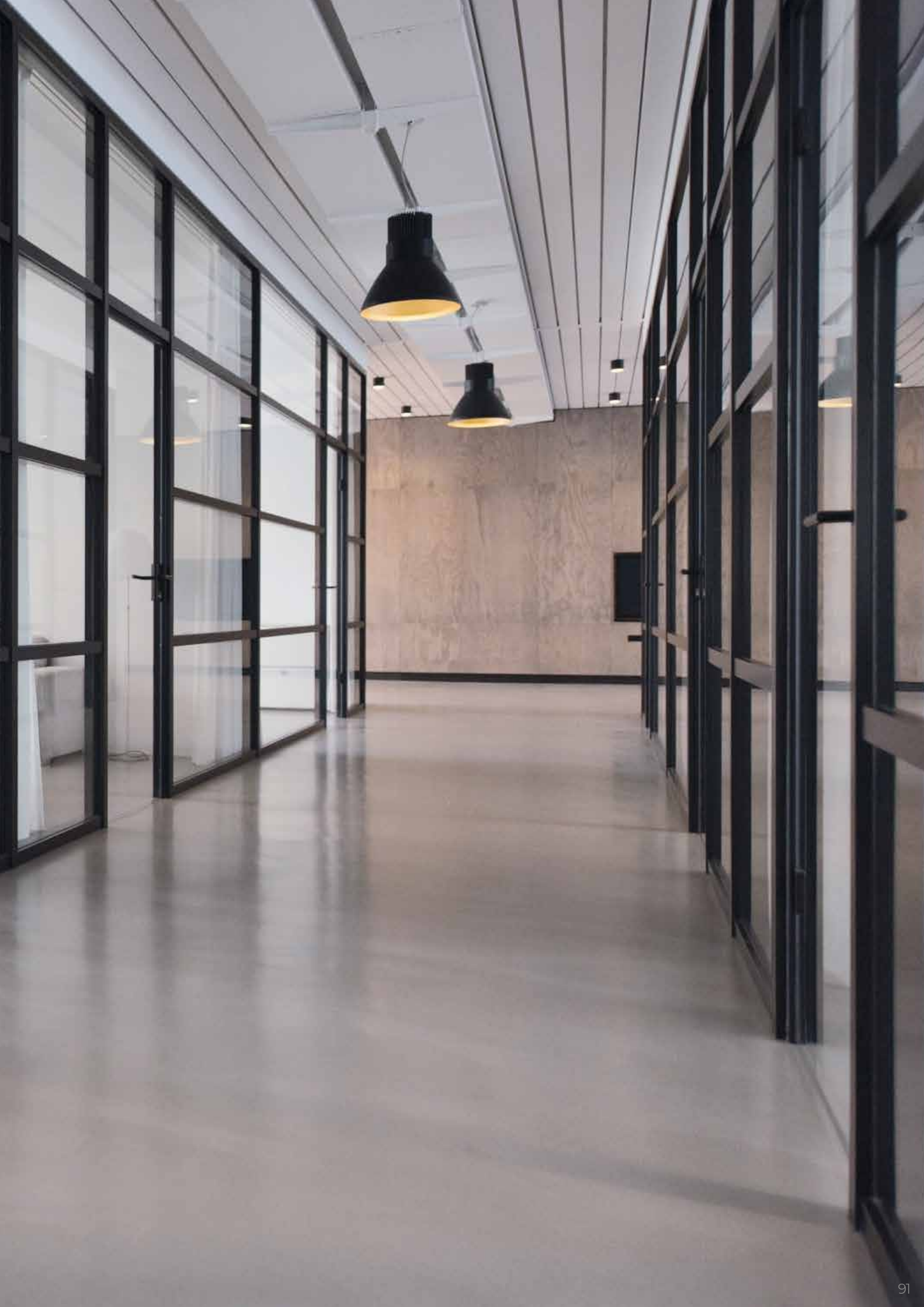

# Funcionalidades

## Functionalities / Fonctionnalités / Funcionalidades



Accesorio que habilita el control inalámbrico de luminarias regulables.

Accessory that enables the wireless control of dimmable luminaires

Accessoire qui permet la commande sans fil des luminaires dimmable.

Acessório que permite o controle sem fio de luminárias dimmable



Un dispositivo por luminaria que permite creación de grupos, escenas, dinamis-mos...

A device for luminaire that allows the creation of groups, scenes, dynamis-ms...

Un dispositif pour luminaire qui permet la création de groupes, scènes, dynamismes...

Um dispositivo para luminária que permite a criação de grupos, cenas, dinamis-mos...



Integrable en redes de control Bluetooth a través de app gratuita Casambi.

Integrated in Bluetooth control networks via free Casambi app.

Intégré dans les réseaux de contrôle Bluetooth via l'appli Casambi gratuite.

Integrado em redes de controle Bluetooth via app Casambi livre.



Dispositivo controlable de manera remota con Smartphone o Tablet Android/iOS.

Remotely controllable device with Smartphone or Android/iOS Tablet.

Appareil contrôlable à distance avec smartphone ou tablette Android/iOS..

Dispositivo remotamente controlável com smartphone ou Android/iOS Tablet.



Sin necesidad de una pasarela u otros dispositivos externos.

Without the need for a walkway or other external devices.

Sans besoin d'une passerelle ou d'autres appareils externes.

Sem a necessidade de uma passarela ou outros dispositivos externos.



Establece automáticamente una red de comunicaciones inalámbrica con un máximo de 127 nodos.

It automatically establishes a wireless communications network with a maximum of 127 nodes.

Il établit automatiquement un réseau de communications sans fil avec un maximum de 127 nœuds.

Ele estabelece automaticamente uma rede de comunicações sem fio com um máximo de 127 nós.



Las actualizaciones de firmware pueden efectuarse, sin conexión por cable, con cualquier dispositivo Android o iOS.

Firmware upgrades can be done without cable connection with any Android device or IOS

Les mises à niveau du firmware peuvent être effectuées sans connexion par câble avec un appareil Android ou IOS.

Upgrades de firmware pode ser feito sem conexão a cabo com qualquer dispositivo Android ou IOS



Fácil implementación de regulaciones de RGB y temperatura del color.

Easy implementation of RGB and color temperature regulations.

Mise en œuvre aisée des réglementations RVB et de la température des couleurs.

Fácil implementação de regulamentos de temperatura de cor e RGB



Hasta 15m de alcance.

Up to 15m of range.

Jusqu'à 15m de portée.

Até 15m de alcance.



Posibilidad de controlar la alimentación del driver mediante relé.

Possibility of controlling the power of the driver by means of a relay.

Possibilité de contrôler la puissance du conducteur au moyen d'un relais.

Possibilidade de controlar o poder do condutor por meio de um relé.



Salida digital: Compatible con DALI autónomo. Salida analógica: Compatible con 1-10V

Digital output: Compatible with stand-alone DALI. Analogic output: Compatible with 1-10V.

Sortie numérique: compatible avec DALI autonome. Sortie analogique: 1-10V conforme

Saída digital: Compatível com DALI autónomo. Saída analógica: Compatível com 1-10V



Versões com envoltório para uso interior (454230) y exterior (550994)

Versions with enclosure for interior use (454230) and exterior (550994)

Versions avec boîtier pour usage intérieur (454230) et extérieur (550994)

Versões com invólucro para uso interior (454230) e exterior (550994)



PUNCH  
TODAY  
IN THE  
FACE.





# Luminarias compatibles

Compatible luminaires / Luminaires compatibles / Luminárias compatíveis

Lynx Led Superficie \*



Lynx Led Line Superficie \*



Lynx Led Empotrar \*



Lynx Led Line Empotrar \*



Lynx Led Pared \*



Stania\*



Silent Led V IP65 \*

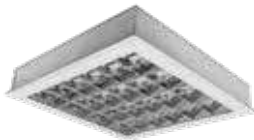

Kobe \*



Kobe Switch \*



Tribola \*



Ebro Led \*



Miño Led \*



\* Bajo pedido  
On request  
Sur commande  
A pedido

AVISO / WARNING / AVERTISSEMENT / AVISO



Versión BLUETOOTH disponible bajo pedido.  
BLUETOOTH version available on request.  
Version BLUETOOTH disponible sur demande.  
Versão BLUETOOTH disponível a pedido.





City



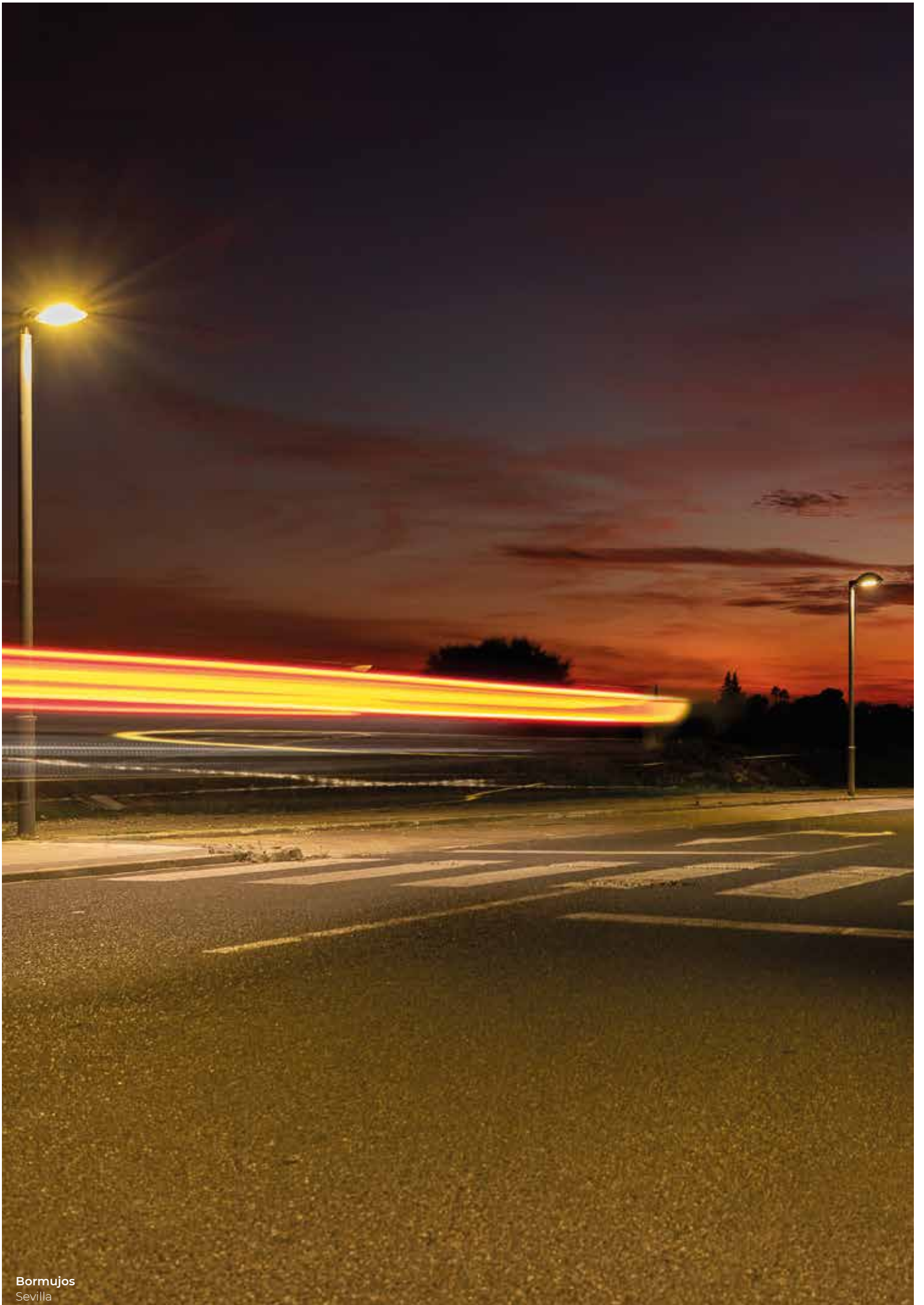

Bormujos  
Sevilla



# Tolerancias

## Tolerance/Tolérance/Tolerância

- Prilux garantiza una tolerancia  $\pm 10\%$  en las medidas de flujo lumínico.

- Prilux garantiza una tolerancia  $\pm 10\%$  en las mediciones de potencia.

- Prilux garantiza una tolerancia  $\pm 10\%$  en temperatura de color.

- Prilux guarantees a tolerance  $\pm 10\%$  in the measurements of luminous flux.

- Prilux guarantees a tolerance  $\pm 10\%$  in the measurements of power.

- Prilux guarantees a tolerance  $\pm 10\%$  in the measurements of color temperature.

- Prilux garantit une tolérance  $\pm 10\%$  dans les mesures de flux lumineux.

- Prilux garantit une tolérance  $\pm 10\%$  dans les mesures de puissance.

- Prilux garantit une tolérance  $\pm 10\%$  dans les mesures de température de couleur.

- Prilux garante uma tolerância  $\pm 10\%$  nas medidas do fluxo luminoso.

- Prilux garante uma tolerância  $\pm 10\%$  nas medidas de potência.

- Prilux garante uma tolerância  $\pm 10\%$  na temperatura de cor.

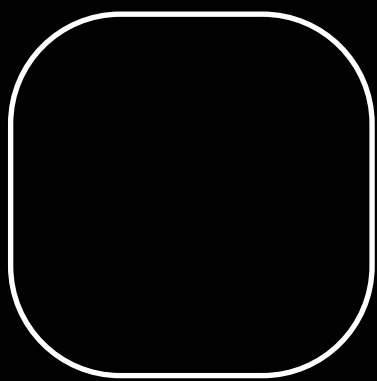

Arisa



# Arisa

**Ñ/** ARISA es la nueva luminaria urbana de PRILUX, funcional, decorativa, elegante, moderna y versátil gracias a los diferentes tipos de fijación y ópticas que dirigen la luz donde es requerida, creando espacios seguros, acogedores y confortables en armonía con el paisaje.

Una solución integral de diseño compacto, líneas actuales y sencillas con la que poder iluminar toda una ciudad manteniendo una estética homogénea.

Descubre en su dossier todo lo relacionado con nuestra luminaria Arisa.

**E/** ARISA is the new urban luminaire from PRILUX, functional, decorative, elegant, modern and versatile thanks to the different types of fixation and optics that direct the light where it is required, creating safe, welcoming and comfortable spaces in harmony with the landscape.

A comprehensive solution with a compact design, modern and simple lines with which to illuminate an entire city while maintaining a homogeneous aesthetic.

Find out everything about our Arisa luminaire in its dossier.

**F/** ARISA est le nouveau luminaire urbain de PRILUX, fonctionnel, décoratif, élégant, moderne et polyvalent grâce aux différents types de fixations et optiques qui dirigent la lumière là où elle est requise, créant des espaces sûrs, accueillants et confortables en harmonie avec le paysage.

Une solution complète au design compact, aux lignes modernes et simples pour illuminer une ville entière tout en conservant une esthétique homogène.

Découvrez dans son dossier tout ce qui concerne notre luminaire Arisa.

**P/** ARISA é a nova luminária urbana da PRILUX, funcional, decorativa, elegante, moderna e versátil graças aos diferentes tipos de fixação e ópticas que dirigem a luz para onde seja necessária, criando espaços seguros, acolhedores e confortáveis em perfeita harmonia com a paisagem.

Uma solução integral de desenho compacto, linhas atuais e simples com a qual pode iluminar toda uma cidade mantendo uma estética homogénea.

Descubra no seu dossier tudo o que está relacionado com a nossa luminária Arisa.





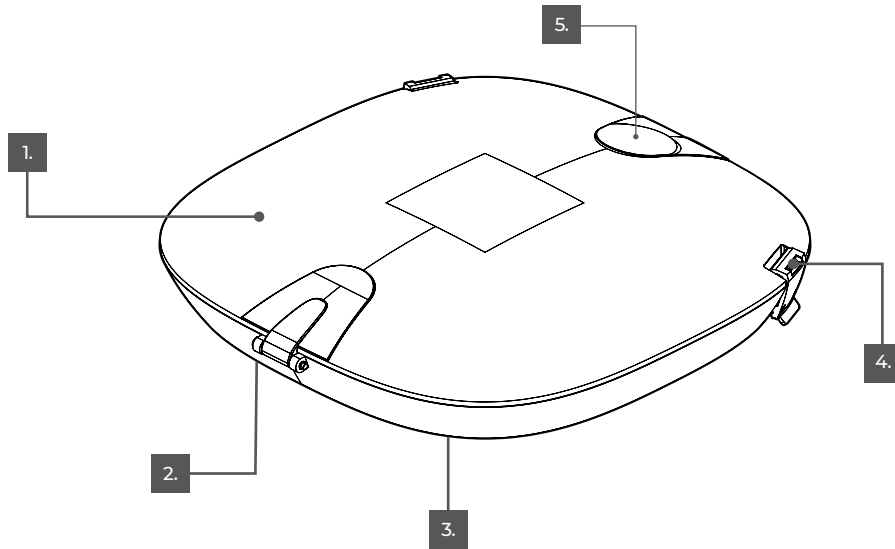

**Ñ/** Diseño compacto.  
**E/** Compact design.  
**F/** Lignes compactes.  
**P/** Lignes compactes.



**Ñ/** Alta eficacia lumínica.  
**E/** High light efficiency.  
**F/** Hautefficacité lumineuse.  
**P/** Alta eficiência luminosa.



**Ñ/** Amplia gama de potencias.  
**E/** Wide range of powers.  
**F/** Large gamme de puissances.  
**P/** Large gamme de puissances.



**Ñ/** Apertura fácil y segura.  
**E/** Easy and safe opening.  
**F/** Ouverture facile et sécurisée.  
**P/** Ouverture facile et sécurisée.



**Ñ/** Posibilidad de telegestión, se adapta para integrar conectores NEMA 7 o ZHAGA BOOK 18.  
**E/** Possibility of remote management, it can be adapted to integrate NEMA 7 or ZHAGA BOOK 18 connectors.  
**F/** Possibilité de gestion à distance, il peut être adapté pour intégrer des connecteurs NEMA 7 ou ZHAGA BOOK 18.  
**P/** Possibilidade de gerenciamento remoto, pode ser adaptado para integrar conectores NEMA 7 ou ZHAGA BOOK 18.



**Ñ/** Diámetros de serie 60 o 76mm.  
**E/** Series diameters 60 or 76mm.  
**F/** Diamètres de série 60 ou 76mm.  
**P/** Diâmetros da série 60 ou 76mm.



**Ñ/** Válvula de presiones, para evitar la formación de humedad.  
**E/** Pressure valve, to avoid the formation of humidity.  
**F/** Soupape de pression, pour éviter la formation d'humidité.  
**P/** Válvula de pressão, para evitar a formação de umidade.

# Arisa

## Road

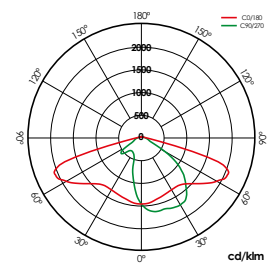
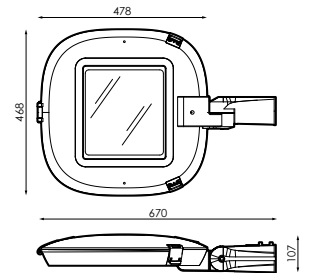

12LED VA00KOM

### ACCESORIOS / ACCESSOIRES / ACCESSORIES / ACESSÓRIOS

+ INFO PAG. 144

586566	INC. 1ud	496636	INC. 1ud	496629	INC. 1ud	501743	INC. 1ud
Kit adaptador a poste y báculo 33mm RAL 9007. Post and rod adapter kit 33mm RAL 9007. Kit adaptateur pole e tige 33mm RAL 9007. Kit de adaptador de poste 33mm e haste RAL 9007.		Kit adaptador a poste y báculo 42mm RAL 9007. Post and rod adapter kit 42mm RAL 9007. Kit adaptateur pole e tige 42mm RAL 9007. Kit de adaptador de poste 42 mme haste RAL 9007.		Kit adaptador a poste y báculo 50mm RAL 9007. Post adapter kit 50mm RAL 9007. Kit adaptateur pole e tige 50mm RAL 9007. Kit de adaptador de poste 50mm e haste RAL 9007.		Kit adaptador a poste y báculo 76mm RAL 9007. Post and rod adapter kit 76mm RAL 9007. Kit adaptateur pole e tige 76mm RAL 9007. Kit de adaptador de poste e haste 76mm RAL 9007.	

[GRÁFICOS: Unidades en mm/GRAPHIQUES: Units in mm/GRAPHICS: Units in mm/GRÁFICOS: Unidades em mm]

⚡ 220-240V

Hz 50-60Hz

☀️ VA00KOM

🌿 >70

η 85%

☀️ 0.0%

🌀 RAL 9007

📏 VT-T

📄 AL iap

📦 Max. 8Kg

📏 0,072m²

⚡ Overstorm

🛡️ Systemshield

📡 CMR

🔄 8N - DALI

🌀 Ø60mm



MADE IN SPAIN  
Desing by PRILUX



Barcode	W <sub>LED</sub>	W <sub>T</sub>	⏏	K	Φ	Φ <sub>LED (1) 25°C</sub>	Φ <sub>LED</sub>	Φ <sub>T</sub>	Φ/W	☀️
572781	12W	13,3W	350mA	3.000K	0,90	2.292lm	2.221lm	1.888lm	142lm/W	12
572804	12W	13,3W	350mA	4.000K	0,90	2.399lm	2.335lm	1.985lm	149lm/W	12
572835	18W	18,8W	500mA	3.000K	0,94	3.163lm	3.061lm	2.602lm	138lm/W	12
572866	18W	18,8W	500mA	4.000K	0,94	3.310lm	3.218lm	2.735lm	145lm/W	12
572880	24W	26,5W	700mA	3.000K	0,97	4.239lm	4.092lm	3.478lm	131lm/W	12
572897	24W	26,5W	700mA	4.000K	0,97	4.437lm	4.301lm	3.656lm	138lm/W	12
572903	36W	38,8W	1.000mA	3.000K	0,98	5.700lm	5.515lm	4.688lm	121lm/W	12
572910	36W	38,8W	1.000mA	4.000K	0,98	5.965lm	5.798lm	4.928lm	127lm/W	12
573009	32W	34,3W	350mA	3.000K	0,91	6.113lm	5.736lm	4.876lm	142lm/W	32
573016	32W	34,3W	350mA	4.000K	0,91	6.397lm	6.031lm	5.126lm	149lm/W	32
573023	48W	49,2W	500mA	3.000K	0,95	8.435lm	7.919lm	6.731lm	137lm/W	32
573030	48W	49,2W	500mA	4.000K	0,95	8.828lm	8.325lm	7.076lm	144lm/W	32
573047	64W	68,7W	500mA	3.000K	0,97	11.305lm	10.555lm	8.972lm	131lm/W	32
573054	64W	68,7W	700mA	4.000K	0,97	11.831lm	11.096lm	9.432lm	137lm/W	32
573061	96W	100,9W	1.000mA	3.000K	0,98	15.200lm	14.021lm	11.918lm	118lm/W	32
573092	96W	100,9W	1.000mA	4.000K	0,98	15.907lm	14.740lm	12.529lm	124lm/W	32

BAJO PEDIDO / ON REQUEST / SUR COMMANDE / A PEDIDO

Soluciones  
Solutions  
Des solutions  
Soluções

Was Outdoor  
Pág. 72

Safelight  
Pág. 68

Cora Manager CMR / PLC / IOT  
Pág. 58  
Consultar / Consult / Consulter / Consultar

🌿	K	🔄	📏	📏	📏
>70	2.700K	DN/LM	CII	PC-T (IK10)	Disponibile colores RAL (Consultar) Available RAL colors (Consult) Couleurs RAL disponibles (Consultar) Cores RAL disponíveis (Consultar)
>80	2.700K	DALI			
	3.000K				
	4.000K				
	PCAmbar/ PCAmbar / PCAmbre/ PCAmber (I≤700mA)				

Níveis programables  
Programmable Levels  
Niveaux programmables  
Níveis programáveis  
Pág. 350

☀️				
VA00LOM	VA00IOP	VA02LOM	SI50LOM	PPILOM
PPDLOM	VA01LOM	VA03DOP	VA04DOP	VA05IOP
VA06IOP	VA07LOP	VA08LOM	PEXLOM	

# Arisa

## Catenaria



<b>N</b> NEW	CI	IP66	IK09	L90B10 > 200,000h (500-1000mA) L90B10 > 200,000h (1-500mA)	-40~+50°C
-----------------	----	------	------	---	-----------

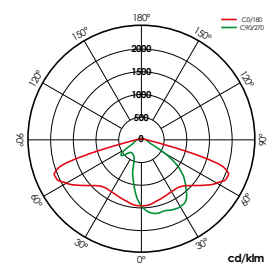
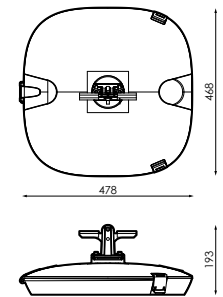

12LED VA00KOM

[GRÁFICOS: Unidades en mm/ GRAPHICS: Units in mm/GRAPHIQUES: Unités en mm/GRÁFICOS: Unidades em mm]



⚡ 220-240V

Hz 50-60Hz

☀️ VA00KOM

🌿 >70

☀️ 0.0%

🌀 RAL 9007

📏 VT-T

📄 AL iap

🏋️ Max. 7kg

🏠 0,02m²

⚡ Overstorm

🛡️ Systemshield

📺 CMR

🕒 8N - DALI



MADE IN SPAIN  
Desing by PRILUX



📏	W <sub>LED</sub>	W <sub>T</sub>	🔌	K	Φ	Φ <sub>LED (H25%)</sub>	Φ <sub>LED</sub>	Φ <sub>T</sub>	Φ/W	☀️
572354	12W	13,3W	350mA	3.000K	0,90	2.292lm	2.221lm	1.888lm	142lm/W	12
572361	12W	13,3W	350mA	4.000K	0,90	2.399lm	2.335lm	1.985lm	149lm/W	12
572378	18W	18,8W	500mA	3.000K	0,94	3.163lm	3.061lm	2.602lm	138lm/W	12
572385	18W	18,8W	500mA	4.000K	0,94	3.310lm	3.218lm	2.735lm	145lm/W	12
572392	24W	26,5W	700mA	3.000K	0,97	4.239lm	4.092lm	3.478lm	131lm/W	12
572408	24W	26,5W	700mA	4.000K	0,97	4.437lm	4.301lm	3.656lm	138lm/W	12
572415	36W	38,8W	1.000mA	3.000K	0,98	5.700lm	5.515lm	4.688lm	121lm/W	12
572422	36W	38,8W	1.000mA	4.000K	0,98	5.965lm	5.798lm	4.928lm	127lm/W	12
572491	32W	34,3W	350mA	3.000K	0,91	6.113lm	5.736lm	4.876lm	142lm/W	32
572507	32W	34,3W	350mA	4.000K	0,91	6.397lm	6.031lm	5.126lm	149lm/W	32
572514	48W	49,2W	500mA	3.000K	0,95	8.435lm	7.919lm	6.731lm	137lm/W	32
572521	48W	49,2W	500mA	4.000K	0,95	8.828lm	8.325lm	7.076lm	144lm/W	32
572538	64W	68,7W	500mA	3.000K	0,97	11.305lm	10.555lm	8.972lm	131lm/W	32
572545	64W	68,7W	700mA	4.000K	0,97	11.831lm	11.096lm	9.432lm	137lm/W	32
572552	96W	100,9W	1.000mA	3.000K	0,98	15.200lm	14.021lm	11.918lm	118lm/W	32
572569	96W	100,9W	1.000mA	4.000K	0,98	15.907lm	14.740lm	12.529lm	124lm/W	32

BAJO PEDIDO / ON REQUEST / SUR COMMANDE / A PEDIDO



K



>70

2.700K

DN/LM

CII

PC-T (IK10)

Disponibles colores RAL (Consultar)  
Available RAL colors (Consult)  
Couleurs RAL disponibles (Consultar)  
Cores RAL disponíveis (Consultar)

>80

2.700K

DALI

3.000K

4.000K

PCAmbar/PCAmbar/  
PCAmbre/PCAmber  
(I≤700mA)



VA00LOM

VA00IOP

VA02LOM

SI50LOM

PPILOM

PPDLOM

VA01LOM

VA03D0P

VA04D0P

VA05IOP

VA06IOP

VA07LOP

VA08LOM

PEXL0M

Soluciones  
Solutions  
Des solutions  
Soluções

Was Outdoor  
Pág. 72

Cora Manager CMR / PLC / IOT  
Pág. 58  
Consultar / Consult / Consultar / Consultar

Níveis programables  
Programmable Levels  
Niveaux programmables  
Níveis programáveis  
Pág. 350

# Arisa

## Top 1



<b>N</b> NEW	CI	IP66	IK09	L90B10 > 200,000h (I=500mA) L90B10 > 200,000h (I=500mA)	-40~+50°C
-----------------	----	------	------	--	-----------

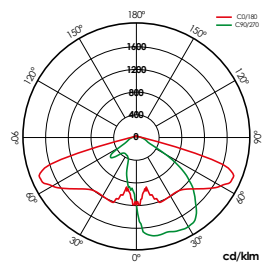
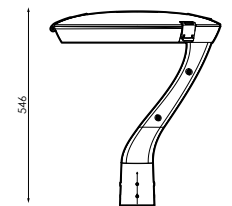
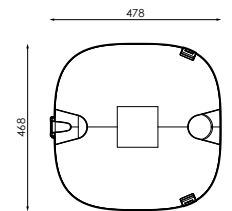

12LED VA00KOM

### ACCESORIOS / ACCESSOIRES / ACCESSORIES / ACESSÓRIOS

+ INFO PAG. 144



586566

INC. 1ud

Kit adaptador a poste y báculo 33mm RAL 9007.  
Post and rod adapter kit 33mm RAL 9007.  
Kit adaptateur pole e tige 33mm RAL 9007.  
Kit de adaptador de poste 33mm e haste RAL 9007.

496636

INC. 1ud

Kit adaptador a poste y báculo 42mm RAL 9007.  
Post and rod adapter kit 42mm RAL 9007.  
Kit adaptateur pole e tige 42mm RAL 9007.  
Kit de adaptador de poste 42 mme haste RAL 9007.

496629

INC. 1ud

Kit adaptador a poste y báculo 50mm RAL 9007.  
Post adapter kit 50mm RAL 9007.  
Kit adaptateur pole e tige 50mm RAL 9007.  
Kit de adaptador de poste 50mm e haste RAL 9007.

[GRÁFICOS: Unidades en mm/GRAPHICS: Units in mm/GRAPHIQUES: Unités en mm/GRÁFICOS: Unidades em mm]

⚡ 220-240V

Hz 50-60Hz

☀️ VA00KOM

🌿 >70

☀️ 0,0%

🌀 RAL 9007

📏 VT-T

📄 AL iap

📦 Max. 8kg

📏 0,188m<sup>2</sup>

⚡ Overstorm

🛡️ Systemshield

📄 CMR

🌀 8N - DALI

📏 Ø60/76mm



**MADE IN SPAIN**  
Desing by PRILUX



	W <sub>LED</sub>	W <sub>T</sub>	☐	K	φ	φ <sub>LED (Tj25°C)</sub>	φ <sub>LED</sub>	φ <sub>T</sub>	φ/W	☀️
573368	12W	13,3W	350mA	3.000K	0,90	2.292lm	2.189lm	1.817lm	137lm/W	12
573375	12W	13,3W	350mA	4.000K	0,90	2.399lm	2.301lm	1.910lm	144lm/W	12
573382	18W	18,8W	500mA	3.000K	0,94	3.163lm	3.017lm	2.504lm	133lm/W	12
573399	18W	18,8W	500mA	4.000K	0,94	3.310lm	3.171lm	2.632lm	140lm/W	12
573405	24W	26,5W	700mA	3.000K	0,97	4.239lm	4.033lm	3.347lm	126lm/W	12
573412	24W	26,5W	700mA	4.000K	0,97	4.437lm	4.239lm	3.518lm	133lm/W	12
573429	36W	38,8W	1.000mA	3.000K	0,98	5.700lm	5.435lm	4.511lm	116lm/W	12
573436	36W	38,8W	1.000mA	4.000K	0,98	5.965lm	5.718lm	4.746lm	122lm/W	12
573504	32W	34,3W	350mA	3.000K	0,91	6.113lm	5.653lm	4.692lm	137lm/W	32
573511	32W	34,3W	350mA	4.000K	0,91	6.397lm	5.942lm	4.932lm	144lm/W	32
573528	48W	49,2W	500mA	3.000K	0,95	8.435lm	7.804lm	6.477lm	132lm/W	32
573535	48W	49,2W	500mA	4.000K	0,95	8.828lm	8.204lm	6.809lm	138lm/W	32
573542	64W	68,7W	700mA	3.000K	0,97	11.305lm	10.401lm	8.633lm	126lm/W	32
573559	64W	68,7W	700mA	4.000K	0,97	11.831lm	10.934lm	9.075lm	132lm/W	32
573566	96W	100,9W	1.000mA	3.000K	0,98	15.200lm	13.817lm	11.468lm	114lm/W	32
573573	96W	100,9W	1.000mA	4.000K	0,98	15.907lm	14.524lm	12.055lm	119lm/W	32

**BAJO PEDIDO / ON REQUEST / SUR COMMANDE / A PEDIDO**

Soluciones  
Solutions  
Des solutions  
Soluções

Was Outdoor  
Pág. 72

Safelight  
Pág. 68

Cora Manager CMR / PLC / IOT  
Pág. 58  
Consultar / Consult / Consulter / Consultar



K



DN/LM



CII



PC-T (IK10)



>70 2.700K  
>80 2.700K  
3.000K  
4.000K

PCAmbar/PCAmbar/  
PCAmbre/PCAmber  
(I≤700mA)

Disponible colores  
RAL (Consultar)  
Available RAL colors  
(Consult)  
Couleurs RAL dispo-  
nibles (Consulter)  
Cores RAL disponí-  
veis (Consultar)



VA00L0M

VA00I0P

VA02L0M

SI50L0M

VA01L0M

VA03D0P

VA04D0P

VA05I0P

VA06I0P

VA07L0P

VA08L0M

Níveis programáveis  
Programmable Levels  
Niveaux programmables  
Níveis programáveis  
Pág. 350

# Arisa

## Top 2

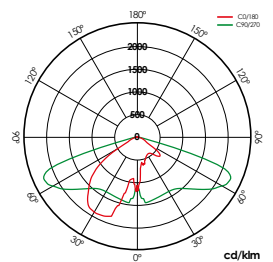
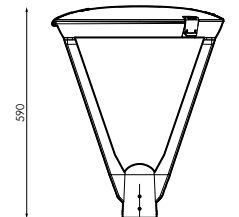
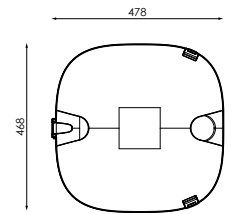

12LED VA00KOM



### ACCESORIOS / ACCESSOIRES / ACCESSORIES / ACESSÓRIOS

+ INFO PAG. 144

586566	INC. 1ud	496636	INC. 1ud	496629	INC. 1ud
Kit adaptador a poste y báculo 33mm RAL 9007. Post and rod adapter kit 33mm RAL 9007. Kit adaptateur pole e tige 33mm RAL 9007. Kit de adaptador de poste 33mm e haste RAL 9007.		Kit adaptador a poste y báculo 42mm RAL 9007. Post and rod adapter kit 42mm RAL 9007. Kit adaptateur pole e tige 42mm RAL 9007. Kit de adaptador de poste 42 mme haste RAL 9007.		Kit adaptador a poste y báculo 50mm RAL 9007. Post adapter kit 50mm RAL 9007. Kit adaptateur pole e tige 50mm RAL 9007. Kit de adaptador de poste 50mm e haste RAL 9007.	

[GRÁFICOS: Unidades en mm/GRÁFICOS: Units in mm/GRAPHICS: Units in mm/GRAPHIQUES: Units en mm/GRÁFICOS: Unidades em mm]



⚡ 220-240V

Hz 50-60Hz

☀️ VA00KOM

🌿 >70

☀️ 0.0%

🌀 RAL 9007

📏 VT-T

📄 AL iap

📦 Max. 8kg

📏 0,188m<sup>2</sup>

⚡ Overstorm

🛡️ Systemshield

📄 CMR

🕒 8N - DALI

📏 Ø60/76mm



**MADE IN SPAIN**  
Desing by PRILUX



	W <sub>LED</sub>	W <sub>T</sub>	⏏	K	φ	φ <sub>LED (1/25°C)</sub>	φ <sub>LED</sub>	φ <sub>T</sub>	φ/W	☀️
573788	12W	13,3W	350mA	3.000K	0,90	2.292lm	2.204m	1.697lm	128lm/W	12
573795	12W	13,3W	350mA	4.000K	0,90	2.399lm	2.316lm	1.783lm	134lm/W	12
573801	18W	18,8W	500mA	3.000K	0,94	3.163lm	3.036m	2.338lm	124lm/W	12
573818	18W	18,8W	500mA	4.000K	0,94	3.310lm	3.191lm	2.457lm	131lm/W	12
573825	24W	26,5W	700mA	3.000K	0,97	4.239lm	4.057lm	3.124lm	118lm/W	12
573832	24W	26,5W	700mA	4.000K	0,97	4.437lm	4.266lm	3.285lm	124lm/W	12
573849	36W	38,8W	1.000mA	3.000K	0,98	5.700lm	5.469lm	4.211lm	109lm/W	12
573856	36W	38,8W	1.000mA	4.000K	0,98	5.965lm	5.845lm	4.501lm	116lm/W	12
573924	32W	34,3W	350mA	3.000K	0,91	6.113lm	5.690lm	4.381lm	128lm/W	32
573931	32W	34,3W	350mA	4.000K	0,91	6.397lm	5.981lm	4.605lm	134lm/W	32
573955	48W	49,2W	500mA	3.000K	0,95	8.435lm	7.853lm	6.047lm	123lm/W	32
573986	48W	49,2W	500mA	4.000K	0,95	8.828lm	8.256lm	6.357lm	129lm/W	32
574013	64W	68,7W	700mA	3.000K	0,97	11.305lm	10.468lm	8.060lm	117lm/W	32
574020	64W	68,7W	700mA	4.000K	0,97	11.831lm	11.004lm	8.473lm	123lm/W	32
574037	96W	100,9W	1.000mA	3.000K	0,98	15.200lm	13.905lm	10.707lm	106lm/W	32
574075	96W	100,9W	1.000mA	4.000K	0,98	15.907lm	14.617lm	11.255lm	112lm/W	32

**BAJO PEDIDO / ON REQUEST / SUR COMMANDE / A PEDIDO**

Soluciones  
Solutions  
Des solutions  
Soluções

Was Outdoor  
Pág. 72

Cora Manager CMR / PLC / IOT  
Pág. 58  
Consultar / Consult / Consulter / Consultar

🌿	K	🕒	📏	📄	🌀
>70	2.700K	DN/LM	CII	PC-T (IK10)	Disponibile colores RAL (Consultar) Available RAL colors (Consult) Couleurs RAL disponibles (Consulter) Cores RAL disponíveis (Consultar)
>80	2.700K	DALI			
	3.000K				
	4.000K				
		PCAmbar/PCAmbar/ PCAmbre/PCAmber (I≤700mA)			

☀️				
VA00L0M	VA00I0P	VA02L0M	SI50L0M	VA01L0M
VA03D0P	VA04D0P	VA05I0P	VA06I0P	VA07L0P
VA08L0M				

Níveis programables  
Programmable Levels  
Niveaux programmables  
Níveis programáveis  
Pág. 350

# Arisa

## Top 4



<b>N</b> NEW	CI	IP66	IK09	 L90B10> 200,000h (500-1481,000mA) L90B10> 200,000h (1-500mA)	-40~+50°C
-----------------	----	------	------	---	-----------

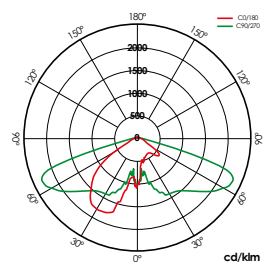
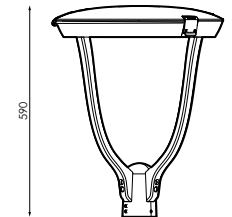
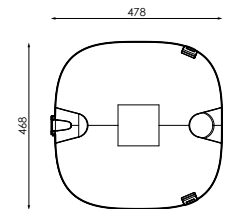

12LED VA00KOM



### ACCESORIOS / ACCESSOIRES / ACCESSORIES / ACESSÓRIOS

+ INFO PAG. 144

586566	INC. 1ud	496636	INC. 1ud	496629	INC. 1ud
Kit adaptador a poste y báculo 33mm RAL 9007. Post and rod adapter kit 33mm RAL 9007. Kit adaptateur pole e tige 33mm RAL 9007. Kit de adaptador de poste 33mm e haste RAL 9007.		Kit adaptador a poste y báculo 42mm RAL 9007. Post and rod adapter kit 42mm RAL 9007. Kit adaptateur pole e tige 42mm RAL 9007. Kit de adaptador de poste 42 mme haste RAL 9007.		Kit adaptador a poste y báculo 50mm RAL 9007. Post adapter kit 50mm RAL 9007. Kit adaptateur pole e tige 50mm RAL 9007. Kit de adaptador de poste 50mm e haste RAL 9007.	

[GRÁFICOS: Unidades en mm/GRAPHICS: Units in mm/GRAPHIQUES: Unités en mm/GRÁFICOS: Unidades em mm]

⚡ 220-240V

Hz 50-60Hz

☀️ VA00KOM

🌿 >70

☀️ 0.0%

🌀 RAL 9007

📏 VT-T

📄 ALiap

🏋️ Max. 9kg

🏠 0,187 m²

⚡ Overstorm

🛡️ Systemshield

📺 CMR

🕒 8N - DALI

📏 Ø60/76mm



MADE IN SPAIN  
Desing by PRILUX



Barcode	W <sub>LED</sub>	W <sub>T</sub>	⏏	K	Φ	Φ <sub>LED (T1,25°C)</sub>	Φ <sub>LED</sub>	Φ <sub>T</sub>	Φ/W	💡
574334	12W	13,3W	350mA	3.000K	0,90	2.292lm	2.238lm	1.701lm	128m/W	12
574358	12W	13,3W	350mA	4.000K	0,90	2.399lm	2.353lm	1.788lm	134lm/W	12
574365	18W	18,8W	500mA	3.000K	0,94	3.163lm	3.083lm	2.343lm	125m/W	12
574372	18W	18,8W	500mA	4.000K	0,94	3.310lm	3.241lm	2.463lm	131lm/W	12
574389	24W	26,5W	700mA	3.000K	0,97	4.239lm	4.121lm	3.132lm	118m/W	12
574396	24W	26,5W	700mA	4.000K	0,97	4.437lm	4.332lm	3.292lm	124lm/W	12
574419	36W	38,8W	1.000mA	3.000K	0,98	5.700lm	5.555lm	4.222lm	109m/W	12
574426	36W	38,8W	1.000mA	4.000K	0,98	5.965lm	5.825lm	4.427lm	114lm/W	12
574495	32W	34,3W	350mA	3.000K	0,91	6.113lm	5.778lm	4.391lm	128m/W	32
574501	32W	34,3W	350mA	4.000K	0,91	6.397lm	6.074lm	4.616lm	135lm/W	32
574518	48W	49,2W	500mA	3.000K	0,95	8.435lm	7.976lm	6.062lm	123m/W	32
574525	48W	49,2W	500mA	4.000K	0,95	8.828lm	8.384lm	6.372lm	130lm/W	32
574532	64W	68,7W	700mA	3.000K	0,97	11.305lm	10.632lm	8.080lm	118m/W	32
574549	64W	68,7W	700mA	4.000K	0,97	11.831lm	11.176lm	8.494lm	124lm/W	32
574556	96W	100,9W	1.000mA	3.000K	0,98	15.200lm	14.122lm	10.733lm	106m/W	32
574563	96W	100,9W	1.000mA	4.000K	0,98	15.907lm	14.846lm	11.283lm	112lm/W	32

BAJO PEDIDO / ON REQUEST / SUR COMMANDE / A PEDIDO

🌿	K	🕒	📏	📏	🌀	🛡️
>70	2.700K	DN/LM	CII	PC-T (IK10)	Disponible colores RAL (Consultar) Available RAL colors (Consult) Couleurs RAL disponibles (Consultar) Cores RAL disponíveis (Consultar)	
>80	2.700K	DALI				
	3.000K					
	4.000K					
		PCAmbar/PCAmbar/ PCAmbre/PCAmber (I≤700mA)				

☀️				
VA00LOM	VA00IOP	VA02LOM	SI50LOM	VA01LOM
VA03DOP	VA04DOP	VA05IOP	VA06IOP	VA07LOP
VA08LOM				

Soluciones  
Solutions  
Des solutions  
Soluções

Was Outdoor  
Pág. 72

Cora Manager CMR / PLC / IOT  
Pág. 58  
Consultar / Consult / Consultar / Consultar

Níveis programables  
Programmable Levels  
Niveaux programmables  
Níveis programáveis  
Pág. 350

CI	IP66	IK08	L90B10> 200,000h (500-161000mA) L90B10> 200,000h (16500mA)	-40~+50 °C (12 Led) -40~+35 °C (24 Led)
----	------	------	---	--

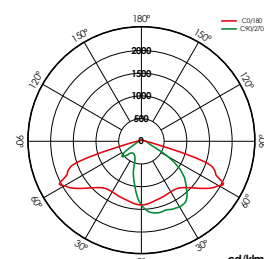
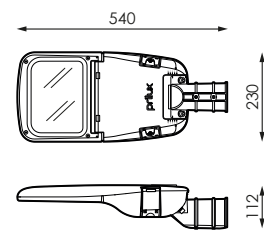

12LED VA00KOM

## ACCESORIOS / ACCESSOIRES / ACCESSORIES / ACESSÓRIOS

+ INFO PAG. 144

586566	INC. 1ud	496636	INC. 1ud	496629	INC. 1ud	501743	INC. 1ud
Kit adaptador a poste y báculo 33mm RAL 9007. Post and rod adapter kit 33mm RAL 9007. Kit adaptateur pole e tige 33mm RAL 9007. Kit de adaptador de poste 33mm e haste RAL 9007.		Kit adaptador a poste y báculo 42mm RAL 9007. Post and rod adapter kit 42mm RAL 9007. Kit adaptateur pole e tige 42mm RAL 9007. Kit de adaptador de poste 42mme haste RAL 9007.		Kit adaptador a poste y báculo 50mm RAL 9007. Post adapter kit 50mm RAL 9007. Kit adaptateur pole e tige 50mm RAL 9007. Kit de adaptador de poste 50mm e haste RAL 9007.		Kit adaptador a poste y báculo 76mm RAL 9007. Post and rod adapter kit 76mm RAL 9007. Kit adaptateur pole e tige 76mm RAL 9007. Kit de adaptador de poste e haste 76mm RAL 9007.	





# Versa L

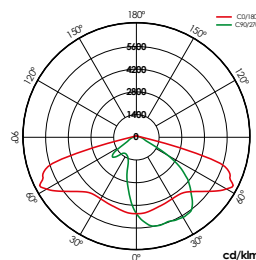
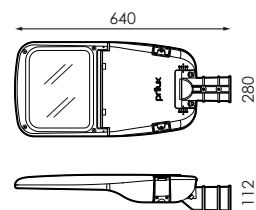

VA00K0M

## ACCESORIOS / ACCESSOIRES / ACCESSORIES / ACESSÓRIOS

+ INFO PAG. 144

586566	INC. 1ud	496636	INC. 1ud	496629	INC. 1ud	501743	INC. 1ud
Kit adaptador a poste y báculo 33mm RAL 9007. Post and rod adapter kit 33mm RAL 9007. Kit adaptateur pole e tige 33mm RAL 9007. Kit de adaptador de poste 33mm e haste RAL 9007.		Kit adaptador a poste y báculo 42mm RAL 9007. Post and rod adapter kit 42mm RAL 9007. Kit adaptateur pole e tige 42mm RAL 9007. Kit de adaptador de poste 42 mme haste RAL 9007.		Kit adaptador a poste y báculo 50mm RAL 9007. Post adapter kit 50mm RAL 9007. Kit adaptateur pole e tige 50mm RAL 9007. Kit de adaptador de poste 50mm e haste RAL 9007.		Kit adaptador a poste y báculo 76mm RAL 9007. Post and rod adapter kit 76mm RAL 9007. Kit adaptateur pole e tige 76mm RAL 9007. Kit de adaptador de poste e haste 76mm RAL 9007.	

[GRÁFICOS: Unidades en mm/GRAPHIQUES: Units in mm/GRAPHICS: Units en mm/GRÁFICOS: Unidades em mm]

⚡ 220-240V

Hz 50-60Hz

🌿 >70

☀️ 0.0%

💡 48

🌀 RAL 9007

📏 VT-T

📄 AL iap

🏋️ Max. 6,5kg

🏠 0,179m²

⚡ Overstorm

🛡️ Systemshield

📺 CMR

🕒 8N - DALI

📏 Ø60mm



MADE IN SPAIN  
Desing by PRILUX



📏	W <sub>LED</sub>	W <sub>T</sub>	🔌	K	Φ	Φ <sub>LED (15.25°C)</sub>	Φ <sub>LED</sub>	Φ <sub>T</sub>	Φ/W	🌿
569934	48W	50,4W	350mA	3.000K	0,95	9.170lm	8.855lm	7.527lm	149lm/W	VA00KOM
569880	48W	50,4W	350mA	4.000K	0,95	9.596lm	9.267lm	7.877lm	156lm/W	VA00KOM
569941	72W	73,0W	500mA	3.000K	0,97	12.653lm	12.127lm	10.308lm	141lm/W	VA00KOM
569897	72W	73,0W	500mA	4.000K	0,97	13.241lm	12.691lm	10.787lm	148lm/W	VA00KOM
569958	96W	101,8W	700mA	3.000K	0,98	16.958lm	15.906lm	13.520lm	133lm/W	VA00KOM
569903	96W	101,8W	700mA	4.000K	0,98	17.747lm	16.646lm	14.149lm	139lm/W	VA00KOM
569965	128W	134,6W	900mA	3.000K	0,98	20.925lm	19.439lm	16.523lm	123lm/W	VA00KOM
569910	128W	134,6W	900mA	4.000K	0,98	21.899lm	20.344lm	17.292lm	128lm/W	VA00KOM
569972	144W	146,7W	1000mA	3.000K	0,98	22.800lm	21.012lm	17.860lm	122lm/W	VA00IOP
569927	144W	146,7W	1000mA	4.000K	0,98	23.860lm	21.988lm	18.690lm	127lm/W	VA00IOP

### BAJO PEDIDO / ON REQUEST / SUR COMMANDE / A PEDIDO

🌿	K	🕒	📏	📏
>70	2.700K	DN/LM	CII	PC-T (IK10)
>80	2.700K	DALI		
	3.000K			
	4.000K			
PCAmbar/PCAmbar/ PCAmbre/PCAmber (I≤700mA)				

🌡️	🌀
+50 °C (Consultar potencias y ópticas disponibles) +50 °C (Consult available powers and optics) +50 °C (Consulter les puissances et optiques disponibles) +50 °C (Consulte potências e óticas disponíveis)	Disponibile colores RAL (Consultar) Available RAL colors (Consult) Couleurs RAL disponibles (Consultar) Cores RAL disponíveis (Consultar)

☀️	VA00LOM (≤900mA)	VA00IOP (≤900mA)	VA02LOM (≤900mA)	S150LOM (≤900mA)	PP1LOM (≤900mA)
	PPDLOM (≤900mA)	VA01LOM (≤900mA)	VA03DOP	VA04DOP	VA05IOP
	VA06IOP	VA07LOP	VA08LOM (≤900mA)	PEXLOM (≤900mA)	

Soluciones  
Solutions  
Des solutions  
Soluções

Cora Manager CMR / PLC / IOT  
Pág. 58  
Consultar/ Consult/ Consultar/ Consultar

Níveis programables  
Programmable Levels  
Niveaux programmables  
Níveis programáveis  
Pág. 350

# Versa XL

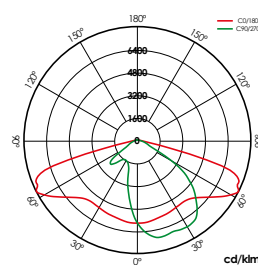
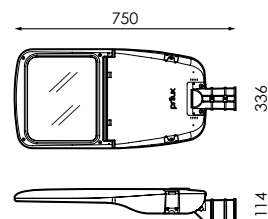

64 LEDS VA00K0M

## ACCESORIOS / ACCESSOIRES / ACCESSORIES / ACESSÓRIOS

+ INFO PAG. 144

586566	INC. 1ud	496636	INC. 1ud	496629	INC. 1ud	501743	INC. 1ud
Kit adaptador a poste y báculo 33mm RAL 9007. Post and rod adapter kit 33mm RAL 9007. Kit adaptateur pole e tige 33mm RAL 9007. Kit de adaptador de poste 33mm e haste RAL 9007.		Kit adaptador a poste y báculo 42mm RAL 9007. Post and rod adapter kit 42mm RAL 9007. Kit adaptateur pole e tige 42mm RAL 9007. Kit de adaptador de poste 42 mme haste RAL 9007.		Kit adaptador a poste y báculo 50mm RAL 9007. Post adapter kit 50mm RAL 9007. Kit adaptateur pole e tige 50mm RAL 9007. Kit de adaptador de poste 50mm e haste RAL 9007.		Kit adaptador a poste y báculo 76mm RAL 9007. Post and rod adapter kit 76mm RAL 9007. Kit adaptateur pole e tige 76mm RAL 9007. Kit de adaptador de poste e haste 76mm RAL 9007.	

[GRÁFICOS: Unidades en mm/GRAPHIQUES: Units in mm/GRAPHICS: Units en mm/GRÁFICOS: Unidades em mm]



⚡ 220-240V

Hz 50-60Hz

🌿 >70

☀️ 0.0%

🌀 RAL 9007

📏 VT-T

📄 AL iap

📦 Max. 8kg

📏 0,252m<sup>2</sup>

⚡ Overstorm

🛡️ Systemshield

🌀 CMR

🌀 Ø60mm



**MADE IN SPAIN**  
Desing by PRILUX

	W <sub>LED</sub>	W <sub>T</sub>	☐	K	Φ	Φ <sub>LED (1,25°C)</sub>	Φ <sub>LED</sub>	Φ <sub>T</sub>	Φ/W	☀️	🌿	🌀
574082	64W	67W	350mA	3.000K	0,95	12.226lm	11.408lm	10.153lm	150lm/W	64	VA00K0M	8N - DALI
574204	64W	67W	350mA	4.000K	0,95	12.795lm	11.938lm	10.625lm	156lm/W	64	VA00K0M	8N - DALI
574099	96W	97W	500mA	3.000K	0,97	16.870lm	15.696lm	13.969lm	144lm/W	64	VA00K0M	8N - DALI
574211	96W	97W	500mA	4.000K	0,97	17.655lm	16.426lm	14.619lm	151lm/W	64	VA00K0M	8N - DALI
574105	128W	134W	700mA	3.000K	0,98	22.610lm	20.444lm	18.195lm	135lm/W	64	VA00K0M	8N - DALI
574228	128W	134W	700mA	4.000K	0,98	23.662lm	21.396lm	19.042lm	141lm/W	64	VA00K0M	8N - DALI
574112	150W	154W	800mA	3.000K	0,99	25.307lm	22.703lm	20.206lm	132lm/W	64	VA00K0M	8N - DALI
574235	150W	154W	800mA	4.000K	0,99	26.484lm	23.760lm	21.146lm	138lm/W	64	VA00K0M	8N - DALI
574129	170W	174W	900mA	3.000K	0,99	27.900lm	25.322lm	22.537lm	129lm/W	64	VA00I0P	8N - DALI
574242	170W	174W	900mA	4.000K	0,99	29.198lm	26.500lm	23.585lm	135lm/W	64	VA00I0P	8N - DALI
574136	192W	194W	1.000mA	3.000K	0,99	30.400lm	27.263lm	24.264lm	124lm/W	64	VA00I0P	8N - DALI
574259	192W	194W	1.000mA	4.000K	0,99	31.813lm	28.530lm	25.392lm	130lm/W	64	VA00I0P	8N - DALI
574143	75W	82W	350mA	3.000K	0,96	15.282lm	14.054lm	12.508lm	152lm/W	80	VA00K0M	8N - DALI
574266	75W	82W	350mA	4.000K	0,96	15.993lm	14.708lm	13.090lm	159lm/W	80	VA00K0M	8N - DALI
574150	110W	117W	500mA	3.000K	0,98	21.088lm	19.313lm	17.189lm	146lm/W	80	VA00K0M	8N - DALI
574273	110W	117W	500mA	4.000K	0,98	22.069lm	20.212lm	17.989lm	153lm/W	80	VA00K0M	8N - DALI
574167	155W	166W	700mA	3.000K	0,99	28.263lm	25.551lm	22.740lm	136lm/W	80	VA00K0M	8N - DALI
574280	155W	166W	700mA	4.000K	0,99	29.576lm	26.737lm	23.796lm	143lm/W	80	VA00K0M	8N - DALI
574174*	180W	197W	800mA	3.000K	0,96	31.634lm	28.272lm	25.162lm	128lm/W	80	VA00I0P	5N - DALI
574297*	180W	197W	800mA	4.000K	0,96	33.105lm	29.587lm	26.332lm	134lm/W	80	VA00I0P	5N - DALI
574181*	206W	223W	900mA	3.000K	0,97	34.876lm	30.951lm	27.546lm	123lm/W	80	VA00I0P	5N - DALI
574303*	206W	223W	900mA	4.000K	0,97	36.498lm	32.390lm	28.827lm	129lm/W	80	VA00I0P	5N - DALI
574198*	230W	249W	1.000mA	3.000K	0,98	37.999lm	33.157lm	29.510lm	118lm/W	80	VA00I0P	5N - DALI
574310*	230W	249W	1.000mA	4.000K	0,98	39.767lm	34.700lm	30.883lm	124lm/W	80	VA00I0P	5N - DALI

**BAJO PEDIDO / ON REQUEST / SUR COMMANDE / A PEDIDO**

🌿	K	🌀	☐	📏
>70	2.700K	DN/LM	CII	PC-T (IK10)
>80	2.700K	DALI		
	3.000K			
	4.000K			

PCAmbar/PCAmbar /  
PCAmbre/PCAmber  
(I≤700mA)



+50 °C (Consultar potencias y ópticas disponibles)  
+50 °C (Consult available powers and optics)  
+50 °C (Consulter les puissances et optiques disponibles)  
+50 °C (Consulte potências e óticas disponíveis)



Disponible colores RAL (Consultar)  
Available RAL colors (Consult)  
Couleurs RAL disponibles (Consultar)  
Cores RAL disponíveis (Consultar)



VA00LOM (≤800mA 64 LEDS) (≤700mA 80 LEDS)	VA00I0P (≤800mA 64 LEDS) (≤700mA 80 LEDS)	VA02LOM (≤800mA 64 LEDS) (≤700mA 80 LEDS)	S150LOM (≤800mA 64 LEDS) (≤700mA 80 LEDS)	VA01LOM (≤800mA 64 LEDS) (≤700mA 80 LEDS)
VA03D0P	VA04D0P	VA05I0P	VA06I0P	VA07LOP
VA08LOM (≤800mA 64 LEDS) (≤700mA 80 LEDS)	PEXL0M (≤800mA 64 LEDS) (≤700mA 80 LEDS)			

•Luminaria no compatible con CORA MANAGER READY/•Luminaire not compatible with CORA MANAGER READY/  
•Luminaire non compatible avec CORA MANAGER READY/•Luminária não compatível com CORA MANAGER READY

Soluciones  
Solutions  
Des solutions  
Soluções

Cora Manager CMR/ PLC / IOT  
Pág. 58  
Consultar/ Consult/ Consultar/ Consultar

Níveis programables  
Programmable Levels  
Niveaux programmables  
Níveis programáveis  
Pág. 350

CI	IP66	IK08	L90B10-200,000h (500-181,000mA) L90B10-200,000h (14500mA)	-40~+50 °C (12 - 48W) -40~+35 °C (72W)
----	------	------	--	---

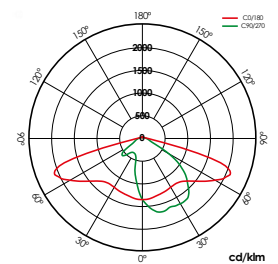
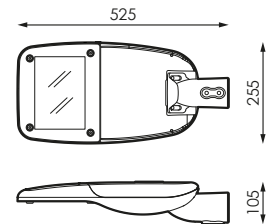

12 LEDS VA00K0M

## ACCESORIOS / ACCESSOIRES / ACCESSORIES / ACESSÓRIOS

+ INFO PAG. 144

479776	INC. 1ud	538282	INC. 1ud	534222	INC. 1ud	501743	INC. 1ud
Kit adaptador a poste y báculo 33mm RAL 9007. Post and rod adapter kit 33mm RAL 9007. Kit adaptateur pole e tige 33mm RAL 9007. Kit de adaptador de poste 33mm e haste RAL 9007.		Kit adaptador a poste y báculo 42mm RAL 9007. Post and rod adapter kit 42mm RAL 9007. Kit adaptateur pole e tige 42mm RAL 9007. Kit de adaptador de poste 42mm e haste RAL 9007.		Kit adaptador a poste y báculo 50mm RAL 9007. Post adapter kit 50mm RAL 9007. Kit adaptateur pole e tige 50mm RAL 9007. Kit de adaptador de poste 50mm e haste RAL 9007.		Kit adaptador a poste y báculo 76mm RAL 9007. Post and rod adapter kit 76mm RAL 9007. Kit adaptateur pole e tige 76mm RAL 9007. Kit de adaptador de poste e haste 76mm RAL 9007.	

⚡ 220-240V

Hz 50-60Hz

☀️ VA00KOM

🌿 >70

☀️ 0.0%

🔄 RAL 9007

📏 VT-T

📄 AL iap

📦 Max. 5kg

📏 0,151m²

⚡ Overstorm

🛡️ Systemshield

📄 CMR

🔄 8N - DALI

📏 Ø60mm



MADE IN SPAIN  
Desing by PRILUX



	W <sub>LED</sub>	W <sub>T</sub>	☐	K	Φ	Φ <sub>LED (T1,25°C)</sub>	Φ <sub>LED</sub>	Φ <sub>T</sub>	Φ/W	☀️
568890	12W	13,3W	350mA	3.000K	0,90	2.292lm	2.156lm	1.854lm	139lm/W	12
568814	12W	13,3W	350mA	4.000K	0,90	2.399lm	2.242lm	1.928lm	145lm/W	12
568906	18W	18,8W	500mA	3.000K	0,94	3.163lm	2.962lm	2.547lm	135lm/W	12
568821	18W	18,8W	500mA	4.000K	0,94	3.310lm	3.079lm	2.648lm	141lm/W	12
568913	24W	26,5W	700mA	3.000K	0,97	4.239lm	3.933lm	3.382lm	128lm/W	12
568838	24W	26,5W	700mA	4.000K	0,97	4.437lm	4.090lm	3.517lm	133lm/W	12
568920	36W	38,8W	1.000mA	3.000K	0,98	5.700lm	5.234lm	4.501lm	116lm/W	12
568845	36W	38,8W	1.000mA	4.000K	0,98	5.965lm	5.442lm	4.680lm	121lm/W	12
568937	24W	26,4W	350mA	3.000K	0,90	4.585lm	4.398lm	3.650lm	138lm/W	24
568852	24W	26,4W	350mA	4.000K	0,90	4.798lm	4.572lm	3.795lm	144lm/W	24
568944	36W	37,0W	500mA	3.000K	0,93	6.326lm	5.931lm	4.923lm	133lm/W	24
568869	36W	37,0W	500mA	4.000K	0,93	6.621lm	6.167lm	5.119lm	138lm/W	24
568951	48W	51,7W	700mA	3.000K	0,96	8.479lm	7.899lm	6.556lm	127lm/W	24
568876	48W	51,7W	700mA	4.000K	0,96	8.873lm	8.213lm	6.817lm	132lm/W	24
568975	72W	74,6W	1.000mA	3.000K	0,97	11.400lm	10.563lm	8.767lm	118lm/W	24
568883	72W	74,6W	1.000mA	4.000K	0,97	11.930lm	10.983lm	9.116lm	122lm/W	24

BAJO PEDIDO / ON REQUEST / SUR COMMANDE / A PEDIDO

🌿	K	🔄	☐	📏
>70	2.700K	DN/LM	CII	PC-T (IK10)
>80	2.700K	DALI		
	3.000K			
	4.000K			

PCAmbar/ PCAmbar /  
PCAmbre/ PCAmber  
(I≤700mA)

Filtro PCAmbar / Filtro  
PCAmbar/ Filtre PCAmbre/  
Filter PCAmber



+50 °C (Consultar potencias y ópticas disponibles)  
+50 °C (Consult available powers and optics)  
+50 °C (Consulter les puissances et optiques disponibles)  
+50 °C (Consulte potências e óticas disponíveis)



Disponibile colores RAL (Consultar)  
Available RAL colors (Consult)  
Couleurs RAL disponibles (Consulter)  
Cores RAL disponíveis (Consultar)



VA00KOM	VA00LOM	VA00IOP	VA02LOM	SI50LOM
PPILOM	PPDLOM	VA01LOM	VA03DOP	VA04DOP
VA05IOP	VA06IOP	VA07LOP	VA08LOM	PEXLOM

Soluciones  
Solutions  
Des solutions  
Soluções

Was Outdoor  
Pág. 72

Safelight  
Pág. 68

Cora Manager CMR/ PLC / IOT  
Pág. 58  
Consultar/ Consult/ Consultar/ Consultar

Níveis programables  
Programmable Levels  
Niveaux programmables  
Níveis programáveis  
Pág. 350

# Avatar L

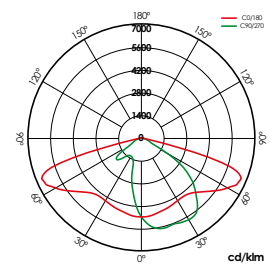
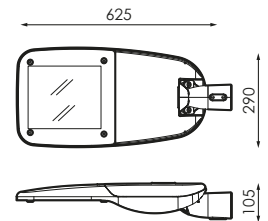

VA00KOM

## ACCESORIOS / ACCESSOIRES / ACCESSORIES / ACESSÓRIOS

+ INFO PAG. 144

479776	INC. 1ud	538282	INC. 1ud	534222	INC. 1ud	501743	INC. 1ud
Kit adaptador a poste y báculo 33mm RAL 9007. Post and rod adapter kit 33mm RAL 9007. Kit adaptateur pole e tige 33mm RAL 9007. Kit de adaptador de poste 33mm e haste RAL 9007.		Kit adaptador a poste y báculo 42mm RAL 9007. Post and rod adapter kit 42mm RAL 9007. Kit adaptateur pole e tige 42mm RAL 9007. Kit de adaptador de poste 42mm e haste RAL 9007.		Kit adaptador a poste y báculo 50mm RAL 9007. Post adapter kit 50mm RAL 9007. Kit adaptateur pole e tige 50mm RAL 9007. Kit de adaptador de poste 50mm e haste RAL 9007.		Kit adaptador a poste y báculo 76mm RAL 9007. Post and rod adapter kit 76mm RAL 9007. Kit adaptateur pole e tige 76mm RAL 9007. Kit de adaptador de poste e haste 76mm RAL 9007.	

[GRÁFICOS: Unidades en mm/GRAPHIQUES: Units in mm/GRAPHICS: Units en mm/GRÁFICOS: Unidades em mm]

⚡ 220-240V

Hz 50-60Hz

🌿 >70

☀️ 0,0%

💡 48

🌀 RAL 9007

📏 VT-T

📄 ALiap

📦 7kg

🏠 0,180m<sup>2</sup>

⚡ Overstorm

🛡️ Systemshield

📺 CMR

🕒 8N - DALI

🌀 ⌀60mm



MADE IN SPAIN  
Desing by PRILUX



📏	W <sub>LED</sub>	W <sub>T</sub>	🔌	K	φ	φ <sub>LED (1) 25°C</sub>	φ <sub>LED</sub>	φ <sub>T</sub>	φ/W	☀️
569392	48W	50,4W	350mA	3.000K	0,95	9.170lm	8.198lm	7.132lm	142lm/W	VA00KOM
569347	48W	50,4W	350mA	4.000K	0,95	9.596lm	8.578lm	7.463lm	148lm/W	VA00KOM
569408	72W	73,0W	500mA	3.000K	0,97	12.653lm	11.116lm	9.671lm	132lm/W	VA00KOM
569354	72W	73,0W	500mA	4.000K	0,97	13.241lm	11.632lm	10.120lm	139lm/W	VA00KOM
569415	96W	101,8W	700mA	3.000K	0,98	16.958lm	14.592lm	12.695lm	125lm/W	VA00KOM
569361	96W	101,8W	700mA	4.000K	0,98	17.747lm	15.271lm	13.286lm	131lm/W	VA00KOM
569422	128W	134,6W	900mA	3.000K	0,98	20.925lm	18.103lm	15.750lm	117lm/W	VA00KOM
569378	128W	134,6W	900mA	4.000K	0,98	21.899lm	18.946lm	16.483lm	122lm/W	VA00KOM
569439	144W	146,7W	1.000mA	3.000K	0,98	22.800lm	19.562lm	17.019lm	116lm/W	VA00IOP
569385	144W	146,7W	1.000mA	4.000K	0,98	23.860lm	20.471lm	17.810lm	121lm/W	VA00IOP

BAJO PEDIDO / ON REQUEST / SUR COMMANDE / A PEDIDO

🌿	K	🕒	📺	📏
>70	2.700K	DN/LM	CII	PC-T (IK10)
>80	2.700K	DALI		
	3.000K			
	4.000K			
PCAmbar/ PCAmbar / PCAmbre/ PCAmber (I≤700mA)				
Filtro PCAmbar / Filtro PCAmbar/ Filtre PCAmbre/ Filter PCAmber (I≤900mA)				
🌡️			🌀	
+50 °C (Consultar potencias y ópticas disponibles) +50 °C (Consult available powers and optics) +50 °C (Consulter les puissances et optiques disponibles) +50 °C (Consulte potências e óticas disponíveis)			Disponibile colores RAL (Consultar) Available RAL colors (Consult) Couleurs RAL disponibles (Consulter) Cores RAL disponíveis (Consultar)	

Soluciones  
Solutions  
Des solutions  
Soluções  
  
Cora Manager CMR/ PLC / IOT  
Pág. 58  
Consultar/ Consult/ Consulter/ Consultar

Níveis programables  
Programmable Levels  
Niveaux programmables  
Níveis programáveis  
Pág. 350

☀️	VA00L0M	VA00I0P	VA02L0M	SI50L0M	PPILOM
	PPDL0M	VA01L0M	VA03D0P	VA04D0P	VA05I0P
	VA06I0P	VA07L0P	VA08L0M	PEXL0M	



# Avatar XL

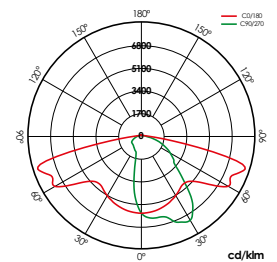
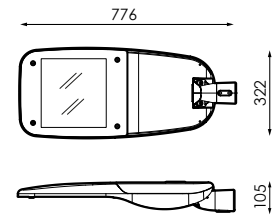

VA00KOM

## ACCESORIOS / ACCESSOIRES / ACCESSORIES / ACESSÓRIOS

+ INFO PAG. 144

479776	INC. 1ud	538282	INC. 1ud	534222	INC. 1ud	501743	INC. 1ud
Kit adaptador a poste y báculo 33mm RAL 9007. Post and rod adapter kit 33mm RAL 9007. Kit adaptateur pole e tige 33mm RAL 9007. Kit de adaptador de poste 33mm e haste RAL 9007.		Kit adaptador a poste y báculo 42mm RAL 9007. Post and rod adapter kit 42mm RAL 9007. Kit adaptateur pole e tige 42mm RAL 9007. Kit de adaptador de poste 42mm e haste RAL 9007.		Kit adaptador a poste y báculo 50mm RAL 9007. Post adapter kit 50mm RAL 9007. Kit adaptateur pole e tige 50mm RAL 9007. Kit de adaptador de poste 50mm e haste RAL 9007.		Kit adaptador a poste y báculo 76mm RAL 9007. Post and rod adapter kit 76mm RAL 9007. Kit adaptateur pole e tige 76mm RAL 9007. Kit de adaptador de poste e haste 76mm RAL 9007.	

[GRÁFICOS: Unidades en mm/GRAPHICS: Units in mm/GRAPHIQUES: Unités en mm/GRÁFICOS: Unidades em mm]

⚡ 220-240V

Hz 50-60Hz

☀️ VA

🌿 >70

☀️ 0.0%

💡 64

🌀 RAL 9007

📄 VT-T

📄 AL iap

📊 9kg

📏 0,251m²

⚡ Overstorm

🛡️ Systemshield

🌀 CMR

🕒 8N - DALI

🌀 Ø60mm



MADE IN SPAIN  
Desing by PRILUX



	W <sub>LED</sub>	W <sub>T</sub>	☐	K	φ	φ <sub>LED (Tj25°C)</sub>	φ <sub>LED</sub>	φ <sub>T</sub>	φ/W	☀️
569569	64W	67,9W	350mA	3.000K	0,95	12.226lm	11.594lm	10.087lm	149lm/W	VA00KOM
569507	64W	67,9W	350mA	4.000K	0,95	12.795lm	12.133lm	10.556lm	155lm/W	VA00KOM
569576	96W	97,0W	500mA	3.000K	0,97	16.870lm	15.707lm	13.665lm	141lm/W	VA00KOM
569514	96W	97,0W	500mA	4.000K	0,97	17.655lm	16.438lm	14.301lm	147lm/W	VA00KOM
569606	128W	135,1W	700mA	3.000K	0,98	22.610lm	20.556lm	17.884lm	132lm/W	VA00KOM
569521	128W	135,1W	700mA	4.000K	0,98	23.662lm	21.513lm	18.716lm	139lm/W	VA00KOM
569613	150W	152,8W	800mA	3.000K	0,99	25.307lm	22.614lm	19.674lm	129lm/W	VA00KOM
569538	150W	152,8W	800mA	4.000K	0,99	26.484lm	23.666lm	20.589lm	135lm/W	VA00KOM
569620	170W	175,1W	900mA	3.000K	0,99	27.900lm	25.169lm	21.897lm	125lm/W	VA00IOP
569545	170W	175,1W	900mA	4.000K	0,99	29.198lm	26.340lm	22.916lm	131lm/W	VA00IOP
569637	192W	195,0W	1.000mA	3.000K	0,99	30.400lm	26.890v	23.394lm	120lm/W	VA00IOP
569552	192W	195,0W	1.000mA	4.000K	0,99	31.813lm	28.139lm	24.481lm	126lm/W	VA00IOP

BAJO PEDIDO / ON REQUEST / SUR COMMANDE / A PEDIDO

🌿	K	🕒	☐	📄
>70	2.700K	DN/LM	CII	PC-T (IK10)
>80	2.700K	DALI		
	3.000K			
	4.000K			
	PCAmbar/ PCAmbar / PCAmbar/ PCAmbar / PCAmbre/ PCAmber (I≤700mA)			
	Filtro PCAmbar / Filtro PCAmbar/ Filtre PCAmbre/ Filter PCAmber (I≤800mA)			
🌡️			🌀	
+50 °C (Consultar potencias y ópticas disponibles) +50 °C (Consult available powers and optics) +50 °C (Consulter les puissances et optiques disponibles) +50 °C (Consulte potências e óticas disponíveis)			🌀	
			Disponible colores RAL (Consultar) Available RAL colors (Consult) Couleurs RAL disponibles (Consulte) Cores RAL disponíveis (Consultar)	

Soluciones  
Solutions  
Des solutions  
Soluções

Cora Manager CMR/ PLC / IOT  
Pág. 58  
Consultar/ Consult/ Consulte/ Consultar

Niveles programables  
Programmable Levels  
Niveaux programmables  
Níveis programáveis  
Pág. 350

☀️	VA00LOM (≤800mA)	VA00IOP (≤800mA)	VA02LOM (≤800mA)	S150LOM (≤800mA)	VA01LOM (≤800mA)
	VA03DOP	VA04DOP	VA05IOP	VA06IOP	VA07LOP
	VA08LOP (≤800mA)	PEXLOM (≤800mA)			

CI	IP66	IK09	L90B10- 200.000h (500-161000mA) L90B10- 200.000h (16500mA)	-40~+50 °C (12 - 64W) -40~+35 °C (75W)
----	------	------	---	---

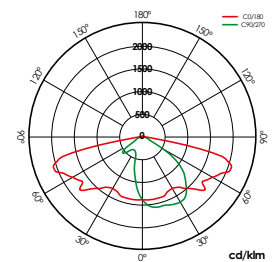
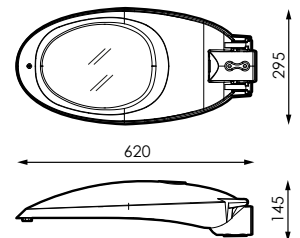

12 LEDS VA00K0M

## ACCESORIOS / ACCESSOIRES / ACCESSORIES / ACESSÓRIOS

+ INFO PAG. 144

405485	INC. 1ud	586535	INC. 1ud	405461	INC. 1ud	501743	INC. 1ud
Kit adaptador a poste y báculo 42mm RAL 9007. Post and rod adapter kit 42mm RAL 9007. Kit adaptateur pole 42mm RAL 9007. Kit de adaptador de poste 42mm e haste RAL 9007.		Kit adaptador a poste y báculo 33mm RAL 9007. Post and rod adapter kit 33mm RAL 9007. Kit adaptateur pole e tige 33mm RAL 9007. Kit de adaptador de poste 33mm e haste RAL 9007.		Kit adaptador a poste y báculo 50mm RAL 9007. Post adapter kit 50mm RAL 9007. Kit adaptateur pole 5 e tige 50mm RAL 9007. Kit de adaptador de poste 50mm e haste RAL 9007.		Kit adaptador a poste y báculo 76mm RAL 9007. Post and rod adapter kit 76mm RAL 9007. Kit adaptateur pole e tige 76mm RAL 9007. Kit de adaptador de poste e haste 76mm RAL 9007.	

## INFORMACIÓN / INFORMATION / INFORMATION / INFORMAÇÕES

**Ñ**/ Reflector de Aluminio de calidad óptica y alta reflectancia >95%.

**E**/ Aluminium reflector of optical quality and high reflectance >95%.

**F**/ Réflecteur en aluminium de qualité optique et de réflectance élevée >95%.

**P**/ Reflector em alumínio de qualidade óptica e elevada reflectância >95%.

⚡ 220-240V

Hz 50-60Hz

☀️ VA00KOM

🌱 >70

☀️ 0.0%

🔒 RAL 9007

🔧 VT-T

📄 AL iap

📦 9kg

🏠 0,231m<sup>2</sup>

⚡ Overstorm

🛡️ Systemshield

🔍 CMR

🔄 8N - DALI

🌀 Ø60mm



**MADE IN SPAIN**  
Desing by PRILUX



	W <sub>LED</sub>	W <sub>T</sub>	☐	K	φ	φ <sub>LED (1) 25°C</sub>	φ <sub>LED</sub>	φ <sub>T</sub>	φ/W	☀️
572705	12W	13,3W	350mA	3.000K	0,90	2.292lm	2.232lm	2.009lm	151lm/W	12
572606	12W	13,3W	350mA	4.000K	0,90	2.399lm	2.337lm	2.103lm	158lm/W	12
572712	18W	18,8W	500mA	3.000K	0,94	3.163lm	3.063lm	2.75lm	147lm/W	12
572613	18W	18,8W	500mA	4.000K	0,94	3.310lm	3.206lm	2.885lm	153lm/W	12
572729	24W	26,5W	700mA	3.000K	0,97	4.239lm	4.100lm	3.690lm	139lm/W	12
572620	24W	26,5W	700mA	4.000K	0,97	4.437lm	4.291lm	3.862lm	146lm/W	12
572736	36W	38,8W	1.000mA	3.000K	0,98	5.700lm	5.517lm	4.965lm	128lm/W	12
572637	36W	38,8W	1.000mA	4.000K	0,98	5.965lm	5.773lm	5.196lm	134lm/W	12
572743	32W	34,3W	350mA	3.000K	0,91	6.113lm	6.006lm	5.405lm	158lm/W	32
572644	32W	34,3W	350mA	4.000K	0,91	6.397lm	6.284lm	5.656lm	165lm/W	32
572750	48W	49,2W	500mA	3.000K	0,95	8.435lm	8.142lm	7.328lm	149lm/W	32
572651	48W	49,2W	500mA	4.000K	0,95	8.828lm	8.521lm	7.669lm	156lm/W	32
572767	64W	68,7W	700mA	3.000K	0,97	11.305lm	10.709lm	9.638lm	140lm/W	32
572668	64W	68,7W	700mA	4.000K	0,97	11.831lm	11.207lm	10.086lm	147lm/W	32
572774	75W	78,8W	800mA	3.000K	0,98	12.654lm	11.649lm	10.484lm	133lm/W	32
572682	75W	78,8W	800mA	4.000K	0,98	13.242lm	12.190lm	10.971lm	139lm/W	32

**BAJO PEDIDO / ON REQUEST / SUR COMMANDE / A PEDIDO**

Soluciones  
Solutions  
Des solutions  
Soluções

Was Outdoor  
Pág. 72

Safelight  
Pág. 68

Cora Manager CMR / PLC / IOT  
Pág. 58  
Consultar / Consult / Consulter / Consultar



>70

2.700K

DN/LM

CII

+50 °C  
(Consultar potencias y ópticas disponibles)  
+50 °C  
(Consult available powers and optics)  
+50 °C  
(Consulter les puissances et optiques disponibles)  
+50 °C  
(Consulte potências e óticas disponíveis)

Disponible colores RAL (Consultar)  
Available RAL colors (Consult)  
Couleurs RAL disponibles (Consultar)  
Cores RAL disponíveis (Consultar)

>80

2.700K

DALI

3.000K

PCAmbar/ PCAmbar /  
PCAmbre/ PCAmber  
(I≤700mA)



VA00LOM  
(≤800mA)

VA00IOP  
(≤800mA)

VA02LOM  
(≤800mA)

S150LOM  
(≤800mA)

VA01LOM  
(≤800mA)

VA03DOP

VA04DOP

VA05IOP

VA06IOP

VA07LOP

VA08LOP  
(≤800mA)

PEXLOM  
(≤800mA)

Níveis programables  
Programmable Levels  
Niveaux programmables  
Níveis programáveis  
Pág. 350

# Sfera



• Incluye Grupo Óptico con ensayos ENAC y certificación ENEC, CB, N. • Incluye Optical Group with ENAC tests and ENEC, CB, N certification. • Comprend Optical Group avec les tests ENAC et les certifications ENEC, CB, N. • Inclui Grupo Óptico com testes ENAC e certificação ENEC, CB, N

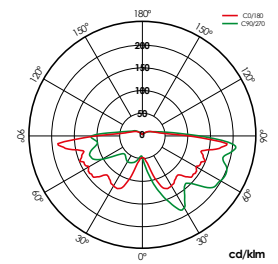
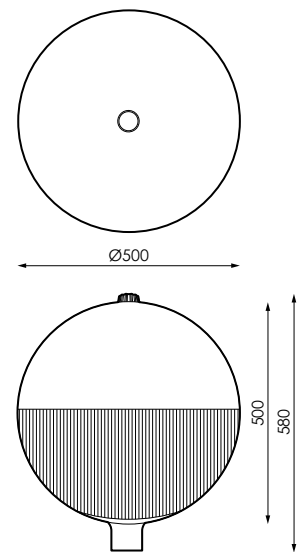

VA00LIM

## ACCESORIOS / ACCESSOIRES / ACCESSORIES / ACESSÓRIOS

+ INFO PAG. 144

587105	INC. 1ud	587112	INC. 1ud	587129	INC. 1ud	587143	INC. 1ud
Kit adaptador a poste y báculo 33mm RAL 9007. Post and rod adapter kit 33mm RAL 9007. Kit adaptateur pole e tige 33mm RAL 9007. Kit de adaptador de poste e haste 33mm RAL 9007.		Kit adaptador a poste y báculo 42mm RAL 9007. Post and rod adapter kit 42mm RAL 9007. Kit adaptateur pole e tige 42mm RAL 9007. Kit de adaptador de poste e haste 42mm RAL 9007.		Kit adaptador a poste y báculo 50mm RAL 9007. Post and rod adapter kit 50mm RAL 9007. Kit adaptateur pole e tige 50mm RAL 9007. Kit de adaptador de poste e haste 50mm RAL 9007.		Kit adaptador a poste y báculo 76mm RAL 9005. Post and rod adapter kit 76mm RAL 9005. Kit adaptateur pole e tige 76mm RAL 9005. Kit de adaptador de poste e haste 76mm RAL 9005.	

[GRÁFICOS: Unidades en mm/GRÁFICOS: Units in mm/GRAPHIQUES: Unités en mm/GRÁFICOS: Unidades em mm]



⚡ 220-240V

Hz 50-60Hz

☀️ VA00LIM

🌱 >70

☀️ 10%

⊙ RAL 9005

📄 PC-P

📄 ALiap

📄 12,5kg

📄 0,196m<sup>2</sup>

⚡ Overstorm

🛡️ Systemshield

📄 CMR

⊙ 8N - DALI

📄 Ø60mm



MADE IN SPAIN  
Desing by PRILUX



Barcode	W <sub>LED</sub>	W <sub>T</sub>	📄	K	φ	φ <sub>LED (T1 25°C)</sub>	φ <sub>LED</sub>	φ <sub>T</sub>	φ/W	☀️
569774	18W	18,8W	500mA	3.000K	0,94	3.163lm	2.966lm	1.750lm	93lm/W	12
569729	18W	18,8W	500mA	4.000K	0,94	3.310lm	3.103lm	1.831lm	97lm/W	12
569781	24W	26,5W	700mA	3.000K	0,97	4.239lm	3.973lm	2.344lm	88lm/W	12
569736	24W	26,5W	700mA	4.000K	0,97	4.437lm	4.158lm	2.453lm	93lm/W	12
569798	36W	38,8W	1.000mA	3.000K	0,98	5.700lm	5.310lm	3.133lm	81lm/W	12
569743	36W	38,8W	1.000mA	4.000K	0,98	5.965lm	5.558lm	3.279lm	85lm/W	12
569804	48W	51,7W	700mA	3.000K	0,96	8.479lm	8.002lm	4.721lm	91lm/W	24
569750	48W	51,7W	700mA	4.000K	0,96	8.873lm	8.373lm	4.940lm	96lm/W	24
569811	72W	74,6W	1.000mA	3.000K	0,97	11.400lm	11.103lm	6.551lm	88lm/W	24
569767	72W	74,6W	1.000mA	4.000K	0,97	11.930lm	11.620lm	6.856lm	92lm/W	24

BAJO PEDIDO / ON REQUEST / SUR COMMANDE / A PEDIDO

🌱	K	⊙	⊙	☀️
>70	2.700K	DN/LM	Disponibile colores RAL (Consultar) Available RAL colors (Consult) Couleurs RAL disponibles (Consultar) Cores RAL disponiveis (Consultar)	S150L1M
>80	2.700K	DALI		
	3.000K			
	4.000K	PCAmbar/PCAmbar/ PCAmbre/PCAmber (I≤700mA)		

Soluciones  
Solutions  
Des solutions  
Soluções

Cora Manager CMR  
Pág. 58

Níveis programables  
Programmable Levels  
Niveaux programmables  
Níveis programáveis  
Pág. 350

# Netta



• Incluye Grupo Óptico con ensayos ENAC y certificación ENEC, CB, N. • Incluye Optical Group with ENAC tests and ENEC, CB, N certification. • Comprend Optical Group avec les tests ENAC et les certifications ENEC, CB, N. • Inclui Grupo Óptico com testes ENAC e certificação ENEC, CB, N

CI	CO / IP67 (12 -24 Led)	IK08	L90B10> 200.000h (50% a 1000mA)	-40~+35°C
	CO / IP66 (32 Led)		L90B10> 200.000h (L=500mA)	

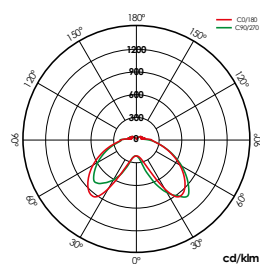
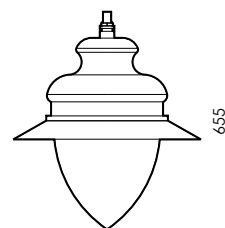
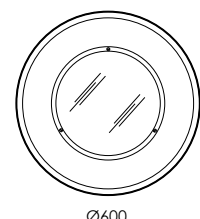

12 LEDS VA00LIM



[GRÁFICOS: Unidades en mm/ GRAPHICS: Units in mm/ GRAPHIQUES: Unités en mm/ GRÁFICOS: Unidades em mm]

⚡ 220-240V

Hz 50-60Hz

🌿 >70

☀️ 0.0%

🌀 RAL 9005

📄 PC-T

📄 AL iap

📄 10kg

📄 0,282m²

⚡ Overstorm

🛡️ Systemshield

🌀 CMR

🌀 8N - DALI

🌀 Ø60mm



MADE IN SPAIN  
Desing by PRILUX



📄	W <sub>LED</sub>	W <sub>T</sub>	📄	K	φ	φ <sub>LED (1) 25°C</sub>	φ <sub>LED</sub>	φ <sub>T</sub>	φ/W	☀️	🌿
572279	18W	18,8W	500mA	3.000K	0,94	3.163lm	3.133lm	2.600lm	138lm/W	12	VA00L1M
572200	18W	18,8W	500mA	4.000K	0,94	3.310lm	3.278lm	2.721lm	145lm/W	12	VA00L1M
572286	24W	26,5W	700mA	3.000K	0,97	4.239lm	4.146lm	3.441lm	130lm/W	12	VA00L1M
572217	24W	26,5W	700mA	4.000K	0,97	4.437lm	4.340lm	3.602lm	136lm/W	12	VA00L1M
572293	36W	38,8W	1.000mA	3.000K	0,98	5.700lm	5.449lm	4.523lm	117lm/W	12	VA00L1M
572224	36W	38,8W	1.000mA	4.000K	0,98	5.965lm	5.702lm	4.733lm	122lm/W	12	VA00L1M
572309	48W	51,7W	700mA	3.000K	0,96	8.479lm	7.840lm	6.507lm	126lm/W	24	VA00L1M
572231	48W	51,7W	700mA	4.000K	0,96	8.873lm	8.204lm	6.809lm	132lm/W	24	VA00L1M
572316	32W	34,3W	350mA	3.000K	0,91	6.113lm	5.756lm	4.029lm	117lm/W	32	VA00K0M
572248	32W	34,3W	350mA	4.000K	0,91	6.397lm	6.023lm	4.216lm	123lm/W	32	VA00K0M
572323	48W	49,2W	500mA	3.000K	0,95	8.435lm	8.043lm	5.630lm	114lm/W	32	VA00K0M
572255	48W	49,2W	500mA	4.000K	0,95	8.828lm	8.417lm	5.892lm	120lm/W	32	VA00K0M
572330	64W	68,7W	700mA	3.000K	0,97	11.305lm	10.609lm	7.426lm	108lm/W	32	VA00K0M
572262	64W	68,7W	700mA	4.000K	0,97	11.831lm	11.101lm	7.771lm	113lm/W	32	VA00K0M

### BAJO PEDIDO / ON REQUEST / SUR COMMANDE / A PEDIDO

🌿	K	🌀	🌀	☀️
>70	2.700K	DN/LM	Disponibile colores RAL (Consultar) Available RAL colors (Consult) Couleurs RAL disponibles (Consultar) Cores RAL disponiveis (Consultar)	S150L1M
>80	2.700K	DALI		S150L0M
	3.000K			
	4.000K			
PCAmbar/ PCAmbar/ PCAmbre/ PCAmber (I≤700mA)				

Soluciones  
Solutions  
Des solutions  
Soluções

Cora Manager CMR  
Pág. 58

Níveis programables  
Programmable Levels  
Niveaux programmables  
Níveis programáveis  
Pág. 350

CI	GO / IP67	DIF / IK09	L90B10 > 200.000h (I<sub>500</sub>=I<sub>1.000</sub>mA)	-40~+35°C
			L90B10 > 200.000h (I<sub>500</sub>=I<sub>1.000</sub>mA)	

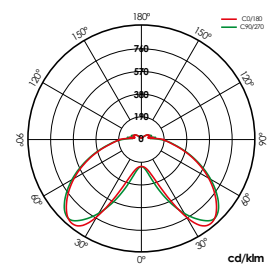
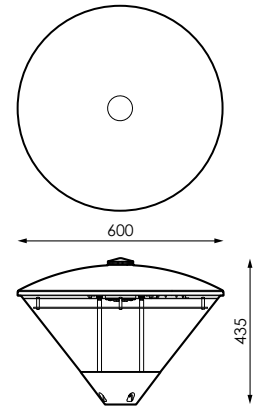

SI50LIM

## ACCESORIOS / ACCESSOIRES / ACCESSORIES / ACESSÓRIOS

+ INFO PAG. 144



587105	INC. 1ud	587112	INC. 1ud	587129	INC. 1ud	587136	INC. 1ud	
Kit adaptador a poste y báculo 33mm RAL 9007. Post and rod adapter kit 33mm RAL 9007. Kit adaptateur pole e tige 33mm RAL 9007. Kit de adaptador de poste e haste 33mm RAL 9007.		Kit adaptador a poste y báculo 42mm RAL 9007. Post and rod adapter kit 42mm RAL 9007. Kit adaptateur pole e tige 42mm RAL 9007. Kit de adaptador de poste e haste 42mm RAL 9007.		Kit adaptador a poste y báculo 50mm RAL 9007. Post and rod adapter kit 50mm RAL 9007. Kit adaptateur pole e tige 50mm RAL 9007. Kit de adaptador de poste e haste 50mm RAL 9007.		Kit adaptador a poste y báculo 76mm RAL 9007. Post and rod adapter kit 76mm RAL 9007. Kit adaptateur pole e tige 76mm RAL 9007. Kit de adaptador de poste e haste 76mm RAL 9007.		

⚡ 220-240V

Hz 50-60Hz

☀️ S150LIM

🌿 >70

☀️ 8,5%

💡 12

🌀 RAL 9007

📄 PC-T

📄 AL iap

📖 9,5kg

📏 0,151m²

⚡ Overstorm

🛡️ Systemshield

📄 CMR

🌀 Ø60mm



MADE IN SPAIN  
Desing by PRILUX



📊	W <sub>LED</sub>	W <sub>T</sub>	🔌	K	φ	φ <sub>LED (1) 25°C</sub>	φ <sub>LED</sub>	φ <sub>T</sub>	φ/W	🌀
572842	24W	26,5W	700mA	3.000K	0,97	4.239lm	3.327lm	2.595lm	98lm/W	8N - DALI
572811	24W	26,5W	700mA	4.000K	0,97	4.437lm	3.482lm	2.716lm	102lm/W	8N - DALI
572873	36W	38,8W	1.000mA	3.000K	0,98	5.700lm	4.435lm	3.459lm	89lm/W	8N - DALI
572828	36W	38,8W	1.000mA	4.000K	0,98	5.965lm	4.641lm	3.620lm	93lm/W	8N - DALI
573351*	44W	47,1W	1.200mA	3.000K	0,96	6.591lm	5.042lm	3.933lm	84lm/W	-
407298*	44W	47,1W	1.200mA	4.000K	0,96	6.897lm	5.277lm	4.116lm	87lm/W	-

\* Luminaria no compatible con CORA MANAGER READY/ \* Luminaire not compatible with CORA MANAGER READY/ \* Luminaire non compatible avec CORA MANAGER READY/ \* Luminária não compatível com CORA MANAGER READY

\* Luminaria no compatible con SYSTEMSHIELD/ \* Luminaire not compatible with SYSTEMSHIELD/ \* Luminaire non compatible avec/ \* Luminaria no compatible con SYSTEMSHIELD/ \* Luminária não compatível com SYSTEMSHIELD

### BAJO PEDIDO / ON REQUEST / SUR COMMANDE / A PEDIDO

Soluciones  
Solutions  
Des solutions  
Soluções

Cora Manager CMR  
Pág. 58

Níveis programables  
Programmable Levels  
Niveaux programmables  
Níveis programáveis  
Pág. 350

🌿	K	🌀	☀️
>70	2.700K	DN/LM	VA00LIM
>80	2.700K	DALI	
	3.000K		
	4.000K		
PCAmbar/PCAmbar/PCAmbr/ PCAmber (I≤700mA)			



# Ircana



• Incluye Grupo Óptico con certificación ENEC, CB, N. • Includes Optical Group with ENEC, CB, N certification. • Comprend Optical Group avec les certifications ENEC, CB, N. • Inclui Grupo Óptico com certificação ENEC, CB, N

CI	GO / IP66-IP67 (12-24 Led) GO / IP66 (32 Led)	GO / IK10 (12-24 Led) GO / IK09 (32 Led)	L90B10> 200.000h (500-1s/1000mA) L90B10> 200.000h (1s/500mA)	-40~+55 °C (12 Led) -40~+35 °C (24 /32 Led)
----	--	---	---	--



3/4 GAS de serie  
3/4 GAS serial  
3/4 GAZ en série  
3/4 GAS serial

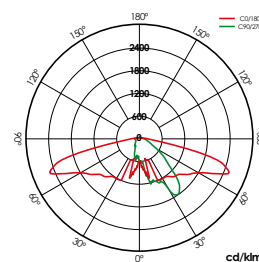
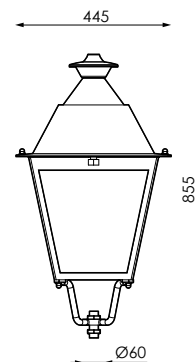

12 LEDS VA00L1P

## ACCESORIOS / ACCESSOIRES / ACCESSORIES / ACESSÓRIOS

+ INFO PAG. 144

594851	INC. 1ud	594868	INC. 1ud	594875	INC. 1ud	503372	INC. 1ud	594882	INC. 1ud
Kit adaptador a poste y báculo 33mm RAL 9005. Post and rod adapter kit 33mm RAL 9005. Kit adaptateur pole e tige 33mm RAL 9005. Kit de adaptador de poste e haste 33mm RAL 9005.		Kit adaptador a poste y báculo 42mm RAL 9005.. Post and rod adapter kit 42mm RAL 9005.. Kit adaptateur pole e tige 42mm RAL 9005.. Kit de adaptador de poste e haste 42mm RAL 9005..		Kit adaptador a poste y báculo 50mm RAL 9005.. Post and rod adapter kit 50mm RAL 9005.. Kit adaptateur pole e tige 50mm RAL 9005.. Kit de adaptador de poste e haste 50mm RAL 9005..		Adaptador a báculo 60mm 60mm rod adapter Adaptateur de tige de 60mm Adaptador de haste de 60mm		Adaptador a poste RAL 9005.. 76mm Post adapter kit 76mm RAL 9005.. Kit adaptateur pole 76mm RAL 9005.. Kit de adaptador de poste 76mm RAL 9005..	

[GRÁFICOS: Unidades en mm/GRÁFICOS: Units in mm/GRAPHIQUES: Unités en mm/GRÁFICOS: Unidades em mm]

⚡ 220-240V

Hz 50-60Hz

🌿 >70

☀️ 0,0%

🌀 RAL 9005

📄 AL

📊 Max. 10kg

📏 0,310m<sup>2</sup>

⚡ Overstorm

🛡️ Systemshield

📄 CMR

🔄 8N - DALI

📏 Ø60mm



MADE IN SPAIN  
Desing by PRILUX



	W <sub>LED</sub>	W <sub>T</sub>	☐	K	φ	φ <sub>LED (1) 25°C</sub>	φ <sub>LED</sub>	φ <sub>T</sub>	φ/W	☀️	☀️
571395	12W	13,3W	350mA	3.000K	0,90	2.292lm	2.155lm	1.595lm	120lm/W	12	VA00LIP
571388	12W	13,3W	350mA	4.000K	0,90	2.399lm	2.255lm	1.669lm	125lm/W	12	VA00LIP
571425	18W	18,8W	500mA	3.000K	0,94	3.163lm	2.964lm	2.193lm	117lm/W	12	VA00LIP
571401	18W	18,8W	500mA	4.000K	0,94	3.310lm	3.101lm	2.295lm	122lm/W	12	VA00LIP
571449	24W	26,5W	700mA	3.000K	0,97	4.239lm	3.966lm	2.935lm	111lm/W	12	VA00LIP
571432	24W	26,5W	700mA	4.000K	0,97	4.437lm	4.151lm	3.072lm	116lm/W	12	VA00LIP
571463	36W	38,8W	1.000mA	3.000K	0,98	5.700lm	5.332lm	3.946lm	102lm/W	12	VA00LIP
571456	36W	38,8W	1.000mA	4.000K	0,98	5.965lm	5.580lm	4.129lm	106lm/W	12	VA00LIP
571517	48W	51,7W	700mA	3.000K	0,96	8.479lm	8.227lm	6.088lm	118lm/W	24	VA00LIP
571500	48W	51,7W	700mA	4.000K	0,96	8.873lm	8.609lm	6.371lm	123lm/W	24	VA00LIP
571531	72W	74,6W	1.000mA	3.000K	0,97	11.400lm	11.226lm	8.307lm	111lm/W	24	VA00LIP
571524	72W	74,6W	1.000mA	4.000K	0,97	11.930lm	11.747lm	8.693lm	117lm/W	24	VA00LIP
571555	32W	34,3W	350mA	3.000K	0,91	6.113lm	5.886lm	3.708lm	108lm/W	32	VA00KOM
571548	32W	34,3W	350mA	4.000K	0,91	6.397lm	6.159lm	3.880lm	113lm/W	32	VA00KOM
571579	48W	49,2W	500mA	3.000K	0,95	8.435lm	8.108lm	5.108lm	104lm/W	32	VA00KOM
571562	48W	49,2W	500mA	4.000K	0,95	8.828lm	8.486lm	5.346lm	109lm/W	32	VA00KOM
571593	64W	68,7W	700mA	3.000K	0,97	11.305lm	10.819lm	6.816lm	99lm/W	32	VA00KOM
571586	64W	68,7W	700mA	4.000K	0,97	11.831lm	11.322lm	7.133lm	104lm/W	32	VA00KOM
571616	75W	78,8W	800mA	3.000K	0,98	12.654lm	12.098lm	7.622lm	97lm/W	32	VA00KOM
571609	75W	78,8W	800mA	4.000K	0,98	13.242lm	12.660lm	7.976lm	101lm/W	32	VA00KOM

BAJO PEDIDO / ON REQUEST / SUR COMMANDE / A PEDIDO

🌿	K	🔄	☐	📄	🌀
>70	2.700K	DN/LM	CII	PC-T (IK10) (Cierre módulo 32LEDs) (Close module 32 LEDs) (Fermer module 32 LEDs) (Feche o módulo 32 LEDs)	Disponible colores RAL (Consultar) Available RAL colors (Consult) Couleurs RAL disponibles (Consulter) Cores RAL disponíveis (Consultar)
>80	2.700K	DALI			
	3.000K				
	4.000K				
	PCAmbar/ PCAmbar/ PCAmbre/ PCAmber (I≤700mA)				

☀️				
VA00L0M	VA00I0P	VA02L0M	S150I1P	S150L0M
VA01L0M	VA03D0P	VA04D0P	VA05I0P	VA06I0P
VA07L0P	VA08L0M	S138L0M		

Soluciones  
Solutions  
Des solutions  
Soluções

Was Outdoor  
Pág. 72

Cora Manager CMR  
Pág. 58

Níveis programables  
Programmable Levels  
Niveaux programmables  
Níveis programáveis  
Pág. 350

# Gaudium



••Incluye Grupo Óptico con ensayos ENAC y certificación ENEC, CB, N. ••Includes Optical Group with ENAC tests and ENEC, CB, N certification. ••Comprend Optical Group avec les tests ENAC et les certifications ENEC, CB, N. ••Inclui Grupo Óptico com testes ENAC e certificação ENEC, CB, N

CI	GO/ IP66-IP67 (12-24 Led) GO/IP66 (32 Led)	L/IK08	L90B10> 200.000h (500-151000mA) L90B10> 200.000h (15500mA)	-40~+35°C
----	--	--------	---	-----------

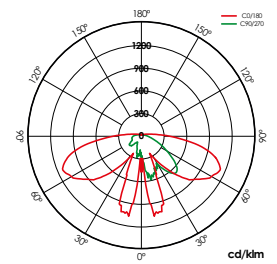
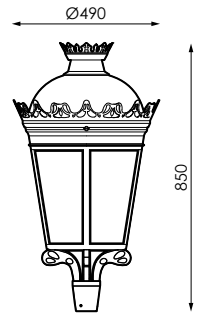

12 LEDS VA00LIP

## ACCESORIOS / ACCESSOIRES / ACCESSORIES / ACESSÓRIOS

+ INFO PAG. 144



587105	INC. 1ud	587112	INC. 1ud	587129	INC. 1ud	587143	INC. 1ud
Kit adaptador a poste y báculo 33mm RAL 9007. Post and rod adapter kit 33mm RAL 9007. Kit adaptateur pole e tige 33mm RAL 9007. Kit de adaptador de poste e haste 33mm RAL 9007.		Kit adaptador a poste y báculo 42mm RAL 9007. Post and rod adapter kit 42mm RAL 9007. Kit adaptateur pole e tige 42mm RAL 9007. Kit de adaptador de poste e haste 42mm RAL 9007.		Kit adaptador a poste y báculo 50mm RAL 9007. Post and rod adapter kit 50mm RAL 9007. Kit adaptateur pole e tige 50mm RAL 9007. Kit de adaptador de poste e haste 50mm RAL 9007.		Kit adaptador a poste y báculo 76mm RAL 9005. Post and rod adapter kit 76mm RAL 9005. Kit adaptateur pole e tige 76mm RAL 9005. Kit de adaptador de poste e haste 76mm RAL 9005.	

••Incluye Grupo Óptico con ensayos ENAC y certificación ENEC, CB, N. ••Includes Optical Group with ENAC tests and ENEC, CB, N certification. ••Comprend Optical Group avec les tests ENAC et les certifications ENEC, CB, N. ••Inclui Grupo Óptico com testes ENAC e certificação ENEC, CB, N

[GRÁFICOS: Unidades en mm/GRAPHIQUES: Units in mm/GRAPHICS: Units in mm/GRÁFICOS: Unidades em mm]

⚡ 220-240V

Hz 50-60Hz

🌿 >70

☀️ 1.3%

🌀 RAL 9005

📏 PC-P

📄 AL iap

🏋️ 9kg

🏠 0,417m²

⚡ Overstorm

🛡️ Systemshield

🌀 CMR

🕒 8N - DALI

🌀 Ø60mm



MADE IN SPAIN  
Desing by PRILUX



📏	W <sub>LED</sub>	W <sub>T</sub>	🔌	K	φ	φ <sub>LED (17.25°)</sub>	φ <sub>LED</sub>	φ <sub>T</sub>	φ/W	☀️	🌿
573252	18W	18,8W	500mA	3.000K	0,94	3.163lm	2.697lm	2.077lm	110lm/W	12	VA00LIP
573184	18W	18,8W	500mA	4.000K	0,94	3.310lm	2.823lm	2.174lm	116lm/W	12	VA00LIP
573269	24W	26,5W	700mA	3.000K	0,97	4.239lm	3.584lm	2.760lm	104lm/W	12	VA00LIP
573191	24W	26,5W	700mA	4.000K	0,97	4.437lm	3.752lm	2.889lm	109lm/W	12	VA00LIP
573276	36W	38,8W	1.000mA	3.000K	0,98	5.700lm	4.775lm	3.677lm	95lm/W	12	VA00LIP
573207	36W	38,8W	1.000mA	4.000K	0,98	5.965lm	4.997lm	3.848lm	99lm/W	12	VA00LIP
573283	48W	51,7W	700mA	3.000K	0,96	8.479lm	6.960lm	5.359lm	104lm/W	24	VA00LIP
573214	48W	51,7W	700mA	4.000K	0,96	8.873lm	7.283lm	5.608lm	108lm/W	24	VA00LIP
573290	32W	34,3W	350mA	3.000K	0,91	6.113lm	4.824lm	3.473lm	101lm/W	32	VA00KOM
573221	32W	34,3W	350mA	4.000K	0,91	6.397lm	5.047lm	3.634lm	106lm/W	32	VA00KOM
573306	48W	49,2W	500mA	3.000K	0,95	8.435lm	6.565lm	4.727lm	96lm/W	32	VA00KOM
573238	48W	49,2W	500mA	4.000K	0,95	8.828lm	6.871lm	4.947lm	101lm/W	32	VA00KOM
573313	64W	68,7W	700mA	3.000K	0,97	11.305lm	8.668lm	6.241lm	91lm/W	32	VA00KOM
573245	64W	68,7W	700mA	4.000K	0,97	11.831lm	9.071lm	6.531lm	95lm/W	32	VA00KOM

BAJO PEDIDO / ON REQUEST / SUR COMMANDE / A PEDIDO

Soluciones  
Solutions  
Des solutions  
Soluções

Was Outdoor  
Pág 72

Cora Manager CMR  
Pág. 58

🌿	K	🕒	📏
>70	2.700K	DN/LM	CII
>80	2.700K	DALI	
	3.000K		
	4.000K		

PCAmbar/ PCAmbar/ PCAmbre/  
PCAmber (I≤700mA)

Niveles programables  
Programmable Levels  
Niveaux programmables  
Níveis programáveis  
Pág. 350

📏	🌀	☀️
PC-T (IK10) (Cierre módulo 32LEDs)	Disponible colores RAL (Consultar) Available RAL colors (Consult) Couleurs RAL disponibles (Consulter) Cores RAL disponíveis (Consultar)	S15011P S150L0M





# Grupo Óptico

LUMINARIA  
TIPO VILLA

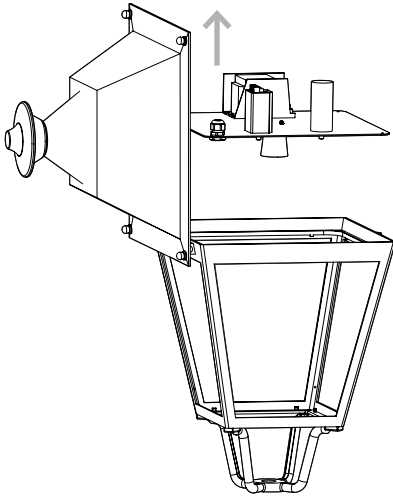

LUMINARIA  
TIPO DECORATIVA

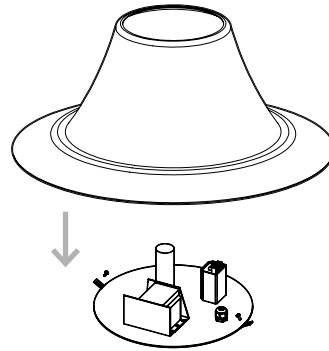

LUMINARIA  
TIPO FERNANDINA

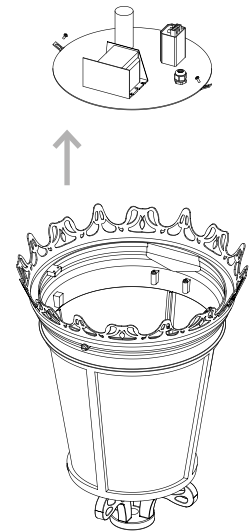

GRUPO ÓPTICO UNIVERSAL  
UNIVERSAL OPTICAL GROUP  
GROUPE OPTIQUE UNIVERSAL  
OPTICAL GROUP UNIVERSAL

ESTUDIO DE ADAPTACIÓN  
ADAPTATION STUDY  
ETUDE DE ADAPTATION  
ESTUDO DE ADAPTAÇÃO

**N/** El grupo óptico universal de PRILUX está ideado para la fácil sustitución de grupos ópticos sin recuperador de flujo de luminarias de alumbrado vial tipo Villa. Es la solución perfecta para la sustitución de grupos ópticos con medidas comprendidas entre 315 y 408mm. Para dimensiones fuera de rango PRILUX realiza estudios de adaptación de módulos LED ajustando a las dimensiones de la luminarias de nuestro cliente.

**E/** The universal PRILUX optical group is conceived for the easy substitution of optical groups without luminaires flux recovery system for street lighting of Villa type. This is the perfect solution for the substitution of optical groups with measures between 315 and 408mm. For different dimensions PRILUX makes adaptation studies of the LED module adapting to the client's luminaires.

**F/** Le groupe optique universel de PRILUX est crée pour la substitution facile de groupes optiques sans récupérateur de flux de luminaires routières type Villa. C'est la parfaite solution pour la substitution de groupes optiques avec des mesures entre 315 et 408mm. Pour des dimensions différentes PRILUX réalise des études d'adaptation de modules à LED adaptant les mesures aux luminaires de notre client.

**P/** O grupo óptico universal da PRILUX, foi idealizado para uma fácil substituição dos grupos ópticos existentes sem recuperador de fluxo em luminárias de iluminação pública tipo Villa. É a solução perfeita para a substituição de grupos opticos com medidas entre 315 e 408mm. Para dimensões fora desta gama a PRILUX realiza estudos de adaptação dos módulos de LED, ajustando às dimensões das luminárias do nosso cliente.

# Grupo Óptico Universal



CI	CO / IP66-IP67 (12 / 24 Led) CO / IP66 (32 Led)	CO / IK10 (12 / 24 Led) CO / IK09 (32 Led)	L90B10 200.000h (500-151.000mA) L90B10 200.000h (15500mA)	-40~+50 °C (12 / 24 Led) -40~+45 °C (32 Led)
----	--	---	--	---

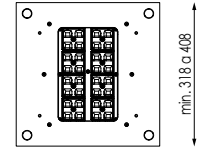
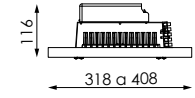

32LEDs

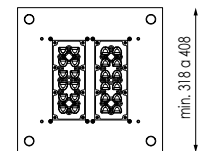
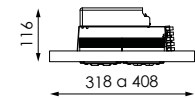

24LEDs

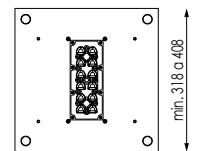
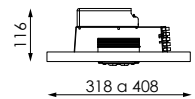

12LEDs

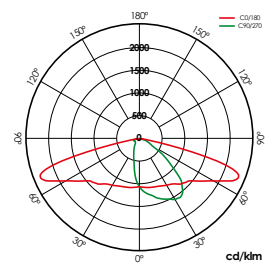
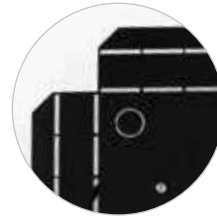
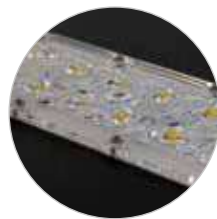

VA00LIP

AVISO / WARNING / AVERTISSEMENT / AVISO

**Ñ /** EI GRUPO OPTICO UNIVERSAL ha sido ensayado satisfactoriamente en nuestro laboratorio dentro de un farol tipo villa a 35°C de temperatura ambiente.

**E /** The UNIVERSAL OPTICAL GROUP has been tested satisfactorily in our laboratory within a villa type lamp at 35°C ambient temperature.

**F /** UNIVERSAL GROUPE OPTIQUE a été testé avec succès dans notre laboratoire dans 35°C température villa type de chambre lanterne.

**P /** UNIVERSAL OPTICAL GROUP foi testado com sucesso em nosso laboratório dentro de 35°C villa temperatura tipo de quarto lanterna.

[GRÁFICOS: Unidades en mm/GRÁFICOS: Units in mm/GRAPHIQUES: Unités en mm/GRÁFICOS: Unidades em mm]

⚡ 220-240V

Hz 50-60Hz

🌿 >70

☀️ 0,0%

🌀 RAL 9005

📦 Max. 4,5kg

⚡ Overstorm

🛡️ Systemshield

📷 CMR

🔄 8N - DALI



**MADE IN SPAIN**  
Desing by PRILUX



12LEDs



24LEDs



32LEDs



	W <sub>LED</sub>	W <sub>T</sub>	📏	K	φ	φ <sub>LED (Tj 25°C)</sub>	φ <sub>LED</sub>	φ <sub>T</sub>	φ/W	☀️	🌿
570909	12W	13,3W	350mA	3.000K	0,90	2.292lm	2.099lm	1.847lm	139lm/W	12	VA00LIP
570893	12W	13,3W	350mA	4.000K	0,90	2.170lm	1.910lm	1.44lm/W	139lm/W	12	VA00LIP
570930	18W	18,8W	500mA	3.000K	0,94	3.163lm	2.886lm	2.540lm	135lm/W	12	VA00LIP
570923	18W	18,8W	500mA	4.000K	0,94	3.310lm	2.985lm	2.627lm	140lm/W	12	VA00LIP
570954	24W	26,5W	700mA	3.000K	0,97	4.239lm	3.863lm	3.399lm	128lm/W	12	VA00LIP
570947	24W	26,5W	700mA	4.000K	0,97	4.437lm	3.995lm	3.516lm	133lm/W	12	VA00LIP
570978	36W	38,8W	1.000mA	3.000K	0,98	5.700lm	5.198lm	4.574lm	118lm/W	12	VA00LIP
570961	36W	38,8W	1.000mA	4.000K	0,98	5.965lm	5.376lm	4.731lm	122lm/W	12	VA00LIP
570992	48W	51,7W	700mA	3.000K	0,96	8.479lm	7.950lm	6.996lm	135lm/W	24	VA00LIP
570985	48W	51,7W	700mA	4.000K	0,96	4.239lm	3.863lm	3.399lm	128lm/W	24	VA00LIP
571029	32W	35,9W	350mA	3.000K	0,92	6.397lm	4.896lm	4.406lm	123lm/W	32	VA00KOM
571012	32W	35,9W	350mA	4.000K	0,92	4.437lm	3.995lm	3.516lm	133lm/W	32	VA00KOM
571043	48W	50,5W	500mA	3.000k	0,96	8.479lm	7.950lm	6.996lm	135lm/W	32	VA00KOM
571036	48W	50,5W	500mA	4.000K	0,96	8.873lm	8.319lm	7.321lm	142lm/W	32	VA00KOM
571067	64W	70,2W	700mA	3.000k	0,97	11.305lm	8.701lm	7.831lm	112lm/W	32	VA00KOM
571050	64W	70,2W	700mA	4.000K	0,97	11.831lm	9.000lm	8.100lm	115lm/W	32	VA00KOM
571081	75W	80,4W	800mA	3.000k	0,98	12.654lm	9729lm	8.756lm	109lm/W	32	VA00KOM
571074	75W	80,4W	800mA	4.000K	0,98	13.242lm	10.063lm	9.057lm	113lm/W	32	VA00KOM

**BAJO PEDIDO / ON REQUEST / SUR COMMANDE / A PEDIDO**

🌿	K	🌀	📏	📷	🌀
>70	2.700K	DN/LM		CII	PC-T (IK10) (Cierre módulo 32LEDs)
>80	2.700K	DALI			Disponibles colores RAL (Consultar) Available RAL colors (Consult) Couleurs RAL disponibles (Consulter) Cores RAL disponíveis (Consultar)
	3.000K				
	4.000K				
	PCAmbar/PCAmbar/ PCAmbre/PCAmber (I≤700mA)				



VA00LOM	VA00IOP	VA02LOM	S150IIP	S150LOM
VA01LOM	VA03DOP	VA04DOP	VA05IOP	VA06IOP
VA07LOP	VA08LOM	S138LOM		

Soluciones  
Solutions  
Des solutions  
Soluções

Cora Manager CMR  
Pág. 58

Níveis programáveis  
Programmable Levels  
Niveaux programmables  
Níveis programáveis  
Pág.350

# Zereus

## Switch



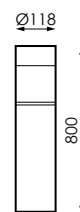

**Con selector de t<sup>º</sup> de color a través de interruptor**  
**With t<sup>º</sup> color selector through switch**  
**Avec sélecteur t<sup>º</sup> de couleur par commutateur**  
**Com o seletor de cores através da chave**

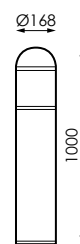

12W

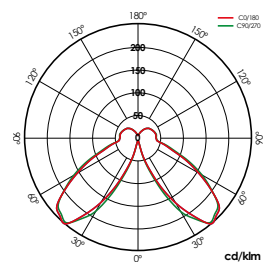

25W



25W

⚡ 100-240V ac

Hz 50-60Hz

Φ 0,9

△ 130°

🌿 >70

⊙ RAL 7010

📄 ALiap



📊	△	W <sub>LED</sub>	W <sub>T</sub>	📄	K	Φ <sub>LED</sub>	Φ <sub>T</sub>	📄
518383	Cuadrada	12W	13W	500mA	3.000K	1.310lm	1.061lm	PC-O
	Cuadrada	12W	13W	500mA	4.000K	1.364lm	1.092lm	PC-O
518413	Circular	25W	26W	1.200mA	3.000K	2.590lm	2.099lm	PC-T
	Circular	25W	26W	1.200mA	4.000K	2.670lm	2.163lm	PC-T



# Accesorios

Accessories

Accessoires

Accessórios

	Arisa Road	Arisa Top 1	Arisa Top 2	Arisa Top 4	Versa	Versa L	Versa XL	Avatar	Avatar L	Avatar XL	Veria	Livia	Sfera	Ircana	Gaudium
586566	.				.	.	.								
586573		.	.	.											
479776								.	.	.					
586535											.				
496636	.				.	.	.								
581417		.	.	.											
538282								.	.	.					
405485											.				
496629	.				.	.	.								
579827		.	.	.											
534222								.	.	.					
405461											.				
501743	.	.	.	.	.	.	.	.	.	.	.				
587105												.	.		.
594851														.	
587112												.	.		.
594868														.	
587129												.	.		.
594875														.	
503372														.	
594882														.	
587136												.			
587143													.		.



586566 INC. 1ud

Kit adaptador a poste y báculo 33mm RAL 9007.  
Post and rod adapter kit 33mm RAL 9007.  
Kit adaptateur pole e tige 33mm RAL 9007.  
Kit de adaptador de poste 33mm e haste RAL 9007.



586573 INC. 1ud

Kit adaptador a poste y báculo 33mm RAL 9007.  
Post and rod adapter kit 33mm RAL 9007.  
Kit adaptateur pole e tige 33mm RAL 9007.  
Kit de adaptador de poste 33mm e haste RAL 9007.



479776 INC. 1ud

Kit adaptador a poste y báculo 33mm RAL 9007.  
Post and rod adapter kit 33mm RAL 9007.  
Kit adaptateur pole e tige 33mm RAL 9007.  
Kit de adaptador de poste 33mm e haste RAL 9007.



586535 INC. 1ud

Kit adaptador a poste y báculo 33mm RAL 9007.  
Post and rod adapter kit 33mm RAL 9007.  
Kit adaptateur pole e tige 33mm RAL 9007.  
Kit de adaptador de poste 33mm e haste RAL 9007.



496636 INC. 1ud

Kit adaptador a poste y báculo 42mm RAL 9007.  
Post and rod adapter kit 42mm RAL 9007.  
Kit adaptateur pole e tige 42mm RAL 9007.  
Kit de adaptador de poste 42 mm e haste RAL 9007.



581417 INC. 1ud

Kit adaptador a poste y báculo 42mm RAL 9007. Post and rod adapter kit 42mm RAL 9007. Kit adaptateur pole e tige 42mm RAL 9007. Kit de adaptador de poste 42mm e haste RAL 9007.



538282 INC. 1ud

Kit adaptador a poste y báculo 42mm RAL 9007. Post and rod adapter kit 42mm RAL 9007. Kit adaptateur pole e tige 42mm RAL 9007. Kit de adaptador de poste 42mm e haste RAL 9007.



405485 INC. 1ud

Kit adaptador a poste y báculo 42mm RAL 9007. Post and rod adapter kit 42mm RAL 9007. Kit adaptateur pole e tige 42mm RAL 9007. Kit de adaptador de poste 42mm e haste RAL 9007.



496629 INC. 1ud

Kit adaptador a poste y báculo 50mm RAL 9007. Post adapter kit 50mm RAL 9007. Kit adaptateur pole e tige 50mm RAL 9007. Kit de adaptador de poste 50mm e haste RAL 9007.



579827 INC. 1ud

Kit adaptador a poste y báculo 50mm RAL 9007. Post adapter kit 50mm RAL 9007. Kit adaptateur pole e tige 50mm RAL 9007. Kit de adaptador de poste 50mm e haste RAL 9007.



534222 INC. 1ud

Kit adaptador a poste y báculo 50mm RAL 9007. Post adapter kit 50mm RAL 9007. Kit adaptateur pole e tige 50mm RAL 9007. Kit de adaptador de poste 50mm e haste RAL 9007.



405461 INC. 1ud

Kit adaptador a poste y báculo 50mm RAL 9007. Post adapter kit 50mm RAL 9007. Kit adaptateur pole e tige 50mm RAL 9007. Kit de adaptador de poste 50mm e haste RAL 9007.



501743 INC. 1ud

Kit adaptador a poste y báculo 76mm RAL 9007. Post and rod adapter kit 76mm RAL 9007. Kit adaptateur pole e tige 76mm RAL 9007. Kit de adaptador de poste e haste 76mm RAL 9007.



587105 INC. 1ud

Kit adaptador a poste y báculo 33mm RAL 9007. Post and rod adapter kit 33mm RAL 9007. Kit adaptateur pole e tige 33mm RAL 9007. Kit de adaptador de poste e haste 33mm RAL 9007.



594851 INC. 1ud

Kit adaptador a poste y báculo 33mm RAL 9005. Post and rod adapter kit 33mm RAL 9005. Kit adaptateur pole e tige 33mm RAL 9005. Kit de adaptador de poste e haste 33mm RAL 9005.



587112 INC. 1ud

Kit adaptador a poste y báculo 42mm RAL 9007. Post and rod adapter kit 42mm RAL 9007. Kit adaptateur pole e tige 42mm RAL 9007. Kit de adaptador de poste e haste 42mm RAL 9007.



594868 INC. 1ud

Kit adaptador a poste y báculo 42mm RAL 9005. Post and rod adapter kit 42mm RAL 9005. Kit adaptateur pole e tige 42mm RAL 9005. Kit de adaptador de poste e haste 42mm RAL 9005.



587129 INC. 1ud

Kit adaptador a poste y báculo 50mm RAL 9007. Post and rod adapter kit 50mm RAL 9007. Kit adaptateur pole e tige 50mm RAL 9007. Kit de adaptador de poste e haste 50mm RAL 9007.



594875 INC. 1ud

Kit adaptador a poste y báculo 50mm RAL 9005. Post and rod adapter kit 50mm RAL 9005. Kit adaptateur pole e tige 50mm RAL 9005. Kit de adaptador de poste e haste 50mm RAL 9005.



503372 INC. 1ud

Adaptador a báculo 60mm RAL 9005. 60mm rod adapter. Adaptateur de tige de 60mm. Adaptador de haste de 60mm.



594882 INC. 1ud

Adaptador a poste RAL 9005. 76mm Post adapter kit 76mm RAL 9005. Kit adaptateur pole 76mm RAL 9005. Kit de adaptador de poste 76mm RAL 9005.



587136 INC. 1ud

Kit adaptador a poste y báculo 76mm RAL 9007. Post and rod adapter kit 76mm RAL 9007. Kit adaptateur pole e tige 76mm RAL 9007. Kit de adaptador de poste e haste 76mm RAL 9007.



587143 INC. 1ud

Kit adaptador a poste y báculo 76mm RAL 9005. Post and rod adapter kit 76mm RAL 9005. Kit adaptateur pole e tige 76mm RAL 9005. Kit de adaptador de poste e haste 76mm RAL 9005.



# Realizaciones

Realizations

Réalisations

Realizações



Proyecto de Iluminación  
L'Alcora  
Valencia

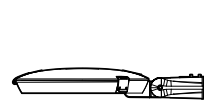

Arisa Road

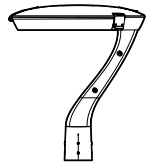

Arisa Top1









Avatar









Proyecto de Iluminación  
Urb. Río Seco  
Murcia

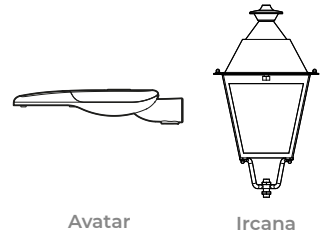









Veria





Veria





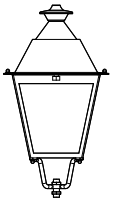

Ircana





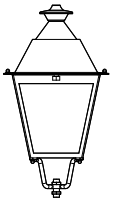

Ircana







Zereus  
Switch













Industrial



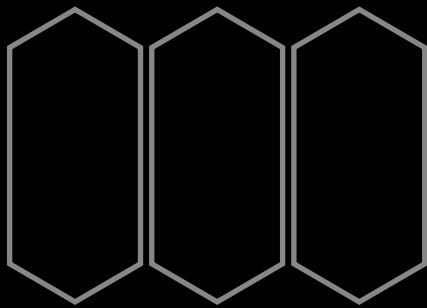

Hexagon  
Zenit





# Hexagon Zenit

**N**/La iluminación industrial requiere soluciones robustas y eficientes. Hexagon Zenit aporta a estas instalaciones una potencia superior y un máximo rendimiento gracias a un flujo luminoso de hasta 51.081 lm y un índice de reproducción cromática mayor a 80.

Hexagon Zenit cuenta con protecciones de sobretensión y protección térmica adecuados a las zonas industriales mediante tecnologías como Overstorm y SystemShield.

**E**/ Industrial lighting requires robust and efficient solutions. Hexagon Zenit provides these installations with superior power and maximum performance thanks to a luminous flux of up to 51,081 lm and a color rendering index greater than 80.



Hexagon Zenit has surge protection and thermal protection suitable for industrial areas through technologies such as Overstorm and SystemShield.

**F**/ L'éclairage industriel nécessite des solutions robustes et performantes. Hexagon Zenit apporte à ces installations une puissance supérieure et des performances maximales grâce à un flux lumineux pouvant atteindre 51 081 lm et un indice de rendu des couleurs supérieur à 80.

Hexagon Zenit dispose d'une protection contre les surtensions et d'une protection thermique adaptées aux zones industrielles grâce à des technologies telles que Overstorm et SystemShield.

**P**/ A iluminação industrial requer soluções robustas e eficientes. O Hexagon Zenit oferece a essas instalações uma potência superior e desempenho máximo graças a um fluxo luminoso de até 51.081 lm e um índice de reprodução de cores superior a 80.

O Hexagon Zenit possui proteção contra surtos e proteção térmica adequada para áreas industriais através de tecnologias como Overstorm e SystemShield.

48Led		144Led	
1x		1x	
Box Integrado		Box Integrado	
PEXL0M	S028L0M	S060L0P	
AINL0M	S068L0M	S090L0P	
AEXL0M	S134L0M	-	
PINL0M	S152L0M	-	
S016L0M	-	-	
Ra ≥70/ 4.000K		Ra ≥70/ 4.000K	
Ra ≥80/ 4.000K		Ra ≥70/ 5.000K	
			

TECNOLOGÍAS/  
+ INFO PAG. 21



De serie/ Serial/ En série/ Serial

playtech

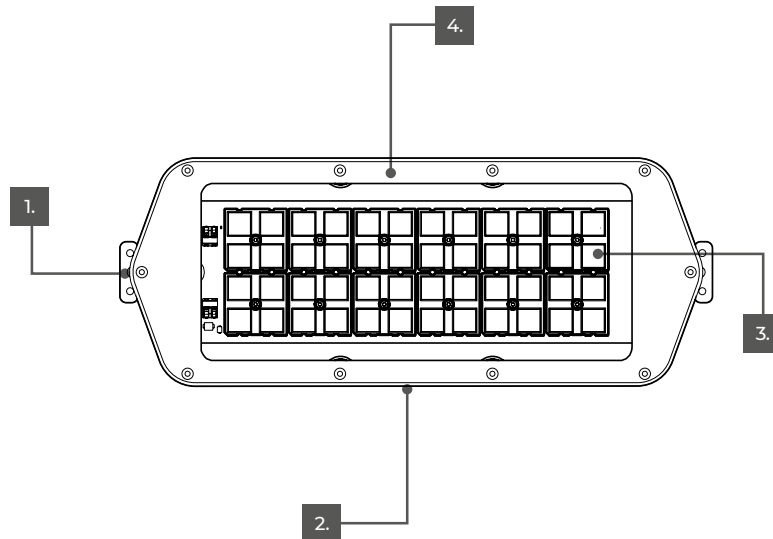

**Ñ/** Cuerpo aluminio inyectado.  
**E/** Die-cast aluminium body.  
**F/** Corps en aluminium moulé sous pression.  
**P/** Corpo em alumínio fundido sob pressão.

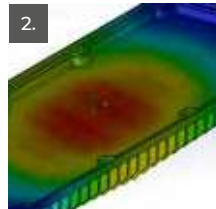

**Ñ/** Disipación de calor.  
**E/** Heat dissipation.  
**F/** Dissipation de la chaleur.  
**P/** Dissipação de calor.



**Ñ/** Diversas Ópticas.  
**E/** Diverse Optics.  
**F/** Optiques diverses.  
**P/** Várias Ópticas.



**Ñ/** Cierre: Difusor de policarbonato con tratamiento UV.  
**E/** Closure: Polycarbonate diffuser with UV-treatment.  
**F/** Fermeture: Diffuseur en polycarbonate avec traitement UV.  
**P/** Fechamento: Difusor em policarbonato com tratamento UV.

# Hexagon

## Zenit 48 Leds

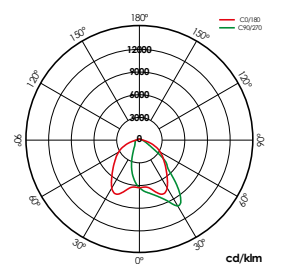
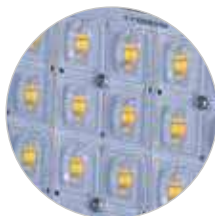
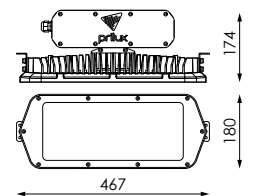

PEXL0M

[GRÁFICOS: Unidades en mm/ GRAPHICS: Units in mm/ GRAPHIQUES: Unités en mm/ GRÁFICOS: Unidades em mm]



⚡ 220-240V

Hz 50-60Hz

Φ 0,98

☀️ PEXL0M

🌸 >70

K 4.000K

☀️ 0,0%

💡 48

🔄 RAL 9007

📏 PC

📦 AL iap

📖 7kg

⚡ Overstorm

🛡️ Systemshield

👤 HCB

🛡️ TESS

🔄 DALI



MADE IN SPAIN  
Desing by PRILUX



468268

$W_{LED}$

144W

$W_T$

150W



1.000mA

$\phi_{LED}$

21.737lm

$\phi_T$

17.403lm

$\phi/W$

116lm/W

BAJO PEDIDO / ON REQUEST / SUR COMMANDE / A PEDIDO



Ra>80

K

4.000K



AINL0M

AEXL0M

PINL0M

SO16L0M

SO28L0M

SO68L0M

SI34L0M

SI52L0M



Kit de emergencia  
Emergency kit  
Kit d'urgence  
Kit de emergência

Soluciones  
Solutions  
Des solutions  
Soluções

Cora Industry Lite  
Pág. 34

# Hexagon

## Zenit 144 Leds

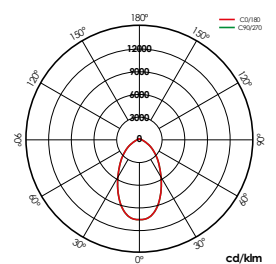
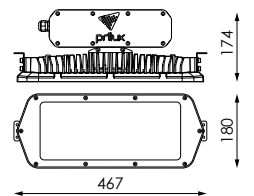
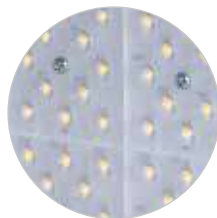

S060L0P

[GRÁFICOS: Unidades en mm/ GRÁFICOS: Units in mm/GRAPHIQUES: Unités en mm/GRÁFICOS: Unidades em mm]

⚡ 220-240V

Hz 50-60Hz

Φ 0,98

☀️ S060L0P

☀️ 0.0%

💡 144

🌀 RAL 9007

📏 VT

📄 AL iap

📊 7kg

⚡ Overstorm

🛡️ Systemshield

🛡️ HCB

🛡️ TESS

🔄 DALI



MADE IN SPAIN  
Desing by PRILUX



BAJO PEDIDO / ON REQUEST / SUR COMMANDE / A PEDIDO

📏	$W_{LED}$	$W_T$	📏	$\phi_{LED}$	$\phi_T$	$\phi/W$	K	🌞
474207	80W	84W	600mA	16.500lm	14.200lm	169lm/W	5000K	>70
474214	80W	84W	600mA	14.800lm	12.800lm	152lm/W	4000K	>80

BAJO PEDIDO / ON REQUEST / SUR COMMANDE / A PEDIDO



PC (IK10)



S090L0P

Soluciones  
Solutions  
Des solutions  
Soluções

Cora Industry  
Pág. 34

# Berlín AVANT

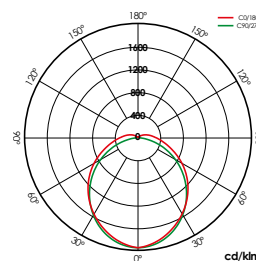
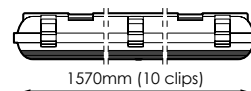
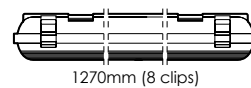
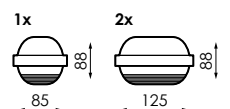

1200mm

## ACCESORIOS / ACCESSOIRES / ACCESSORIES / ACESSÓRIOS

+ INFO PAG.176

378369 INC. 6ud

Kit 6 clips plástico 600mm  
Kit 6 plastic clips 600mm  
Kit 6 clips plastique 600mm  
Kit 6 clips de plástico 600mm

378376 INC. 8ud

Kit 8 clips plástico 1.200mm  
Kit 8 plastic clips 1.200mm  
Kit 8 clips plastique 1.200mm  
Kit 8 clips de plástico 1.200mm

378406 INC. 10ud

Kit 10 clips plástico 1.500mm  
Kit 10 plastic clips 1.500mm  
Kit 10 clips plastique 1.500mm  
Kit 10 clips de plástico 1.500mm



⚡ 220-240V

Hz 50-60Hz

🌿 >80

🌀 GR Claro

📄 PO

📄 PC

📦 2,6kg

↑ Superficie



MADE IN SPAIN  
Desing by PRILUX

	W <sub>LED</sub>	W <sub>T</sub>	☐	φ	φ <sub>LED</sub>	φ <sub>T</sub>	K	☀	↕
550420	1x13W	15W	350mA	0,9	1.641lm	1.444lm	3.000K	24	660 x 85 x 88mm - 1x
550437	1x13W	15W	350mA	0,9	1.710lm	1.505lm	4.000K	24	660 x 85 x 88mm - 1x
550444	1x13W	15W	350mA	0,9	1.795lm	1.581lm	5.000K	24	660 x 85 x 88mm - 1x
550758	1x 22W	24W	300mA	0,93	2.880lm	2.534lm	3.000K	48	1.270 x 85 x 88mm - 1x
550765	1x 22W	24W	300mA	0,93	3.000lm	2.640lm	4.000K	48	1.270 x 85 x 88mm - 1x
550772	1x 22W	24W	300mA	0,93	3.150lm	2.772lm	5.000K	48	1.270 x 85 x 88mm - 1x
550789	1x 26W	28W	350mA	0,95	3.282lm	2.888lm	3.000K	48	1.270 x 85 x 88mm - 1x
550796	1x 26W	28W	350mA	0,95	3.420lm	3.010lm	4.000K	48	1.270 x 85 x 88mm - 1x
550802	1x 26W	28W	350mA	0,95	3.591lm	3.161lm	5.000K	48	1.270 x 85 x 88mm - 1x
550819	1x 30W	32W	390mA	0,95	3.696lm	3.252lm	3.000K	48	1.270 x 85 x 88mm - 1x
550826	1x 30W	32W	390mA	0,95	3.850lm	3.388lm	4.000K	48	1.270 x 85 x 88mm - 1x
550833	1x 30W	32W	390mA	0,95	4.043lm	3.558lm	5.000K	48	1.270 x 85 x 88mm - 1x
550840	1x 28W	30W	300mA	0,95	3.600lm	3.096lm	3.000K	60	1.570 x 85 x 88mm - 1x
550857	1x 28W	30W	300mA	0,95	3.750lm	3.225lm	4.000K	60	1.570 x 85 x 88mm - 1x
550864	1x 28W	30W	300mA	0,95	3.938lm	3.387lm	5.000K	60	1.570 x 85 x 88mm - 1x
550871	1x 33W	35W	350mA	0,96	4.200lm	3.612lm	3.000K	60	1.570 x 85 x 88mm - 1x
550888	1x 33W	35W	350mA	0,96	4.375lm	3.763lm	4.000K	60	1.570 x 85 x 88mm - 1x
550895	1x 33W	35W	350mA	0,96	4.594lm	3.952lm	5.000K	60	1.570 x 85 x 88mm - 1x
550901	1x 37W*	39W	390mA	0,96	4.619lm	3.973lm	3.000K	60	1.570 x 85 x 88mm - 1x
550918	1x 37W*	39W	390mA	0,96	4.812lm	4.139lm	4.000K	60	1.570 x 85 x 88mm - 1x
550925	1x 37W*	39W	390mA	0,96	5.053lm	4.346lm	5.000K	60	1.570 x 85 x 88mm - 1x
550574	2 x 11W	24W	300mA	0,94	2.800lm	2.534lm	3.000K	48	660 x 125 x 88mm - 2x
550581	2 x 11W	24W	300mA	0,94	3.000lm	2.640lm	4.000K	48	660 x 125 x 88mm - 2x
550598	2 x 11W	24W	300mA	0,94	3.150lm	2.772lm	5.000K	48	660 x 125 x 88mm - 2x
550604	2 x 22W	46W	300mA	0,96	5.760lm	5.069lm	3.000K	96	1.270 x 125 x 88mm - 2x
550611	2 x 22W	46W	300mA	0,96	6.000lm	5.280lm	4.000K	96	1.270 x 125 x 88mm - 2x
550628	2 x 22W	46W	300mA	0,96	6.300lm	5.554lm	5.000K	96	1.270 x 125 x 88mm - 2x
550635	2 x 26W	54W	350mA	0,97	6.564lm	5.776lm	3.000K	96	1.270 x 125 x 88mm - 2x
550642	2 x 26W	54W	350mA	0,97	6.840lm	6.019lm	4.000K	96	1.270 x 125 x 88mm - 2x
550659	2 x 26W	54W	350mA	0,97	7.182lm	6.320lm	5.000K	96	1.270 x 125 x 88mm - 2x
550666	2 x 30W	62W	400mA	0,98	7.392lm	6.504lm	3.000K	96	1.270 x 125 x 88mm - 2x
550673	2 x 30W	62W	400mA	0,98	7.700lm	6.776lm	4.000K	96	1.270 x 125 x 88mm - 2x
550680	2 x 30W	62W	400mA	0,98	8.086lm	7.116lm	5.000K	96	1.270 x 125 x 88mm - 2x
550697	2 x 28W	57W	300mA	0,97	7.200lm	6.192lm	3.000K	120	1.570 x 125 x 88mm - 2x
550703	2 x 28W	57W	300mA	0,97	7.500lm	6.450lm	4.000K	120	1.570 x 125 x 88mm - 2x
550710	2 x 28W	57W	300mA	0,97	7.875lm	6.773lm	5.000K	120	1.570 x 125 x 88mm - 2x
550727	2 x 37W*	76W	400mA	0,96	9.240lm	7.946lm	3.000K	120	1.570 x 125 x 88mm - 2x
550734	2 x 37W*	76W	400mA	0,96	9.625lm	8.278lm	4.000K	120	1.570 x 125 x 88mm - 2x
550741	2 x 37W*	76W	400mA	0,96	10.107lm	8.692lm	5.000K	120	1.570 x 125 x 88mm - 2x

Soluciones  
Solutions  
Des solutions  
Soluções

Cora Industry  
Pág. 34



Necesita driver DALI  
You need DALI driver  
Vous avez besoin d'un driver DALI  
Você precisa da driver DALI

BAJO PEDIDO / ON REQUEST / SUR COMMANDE / A PEDIDO

K

6.500K



1-10V

DALI  
(mod.1.200mm/1.500mm)



Kit de emergencia 3h.  
Emergency kit 3h.  
Kit d'urgence 3h.  
Kit de emergência 3h.  
(mod.1.200mm/1.500mm)



Sensor de presencia y  
luminosidad  
Presence and brightness  
sensor  
Présence et capteur de  
lumière  
Sensor de presença e  
luminosidade.  
(mod.1.200mm/1.500mm)

\*Máxima temperatura de trabajo 30°C / \*Maximum working temperature 30°C /  
\*La température maximale de 30°C / \*A temperatura máxima de 30°C

# Benzine Élite

## Empotrar

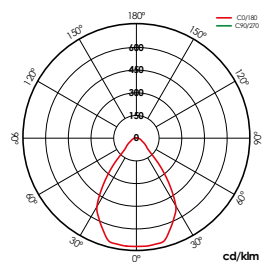
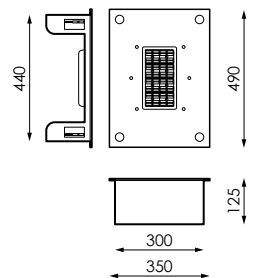
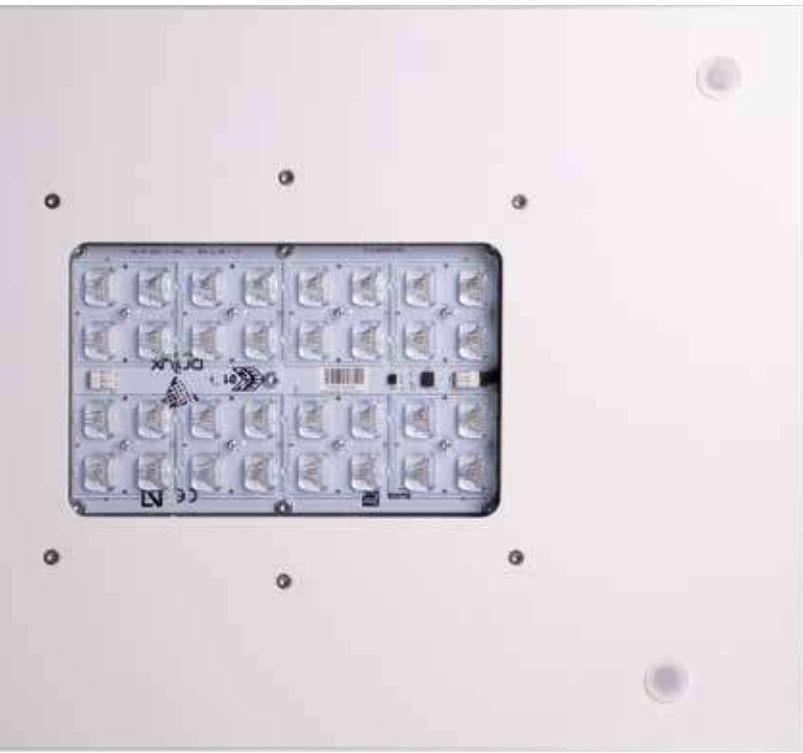

S069L0P

ACCESORIOS / ACCESSOIRES / ACCESSORIES / ACESSÓRIOS

+ INFO PAG. 176

493994

INC. 1ud

Marco Benzine Élite  
 Frame Benzine Élite  
 Cadre Benzine Élite  
 Quadro Benzine Élite

[GRÁFICOS: Unidades en mm/GRÁFICOS: Unités en mm/GRÁFICOS: Unidades em mm/GRÁFICOS: Unidades em mm]

⚡ 220-240V

Hz 50-60Hz

Φ >0.9

🌿 >70

K 4.000K

☀️ S069L0P

☀️ 0.0%

💡 32

🔗 BL

📏 VT

📦 FE

📦 15kg

⚡ Overstorm

🛡️ Systemshield

🕒 DN/LM

↑ Empotrar



MADE IN SPAIN  
Desing by PRILUX



491662



96W



97W



1.000mA



14.893lm



13.033lm



440x300mm

Soluciones  
Solutions  
Des solutions  
Soluções

Cora Industry  
Pág. 34



Necesita driver DALI  
You need DALI driver  
Vous avez besoin d'un driver DALI  
Você precisa da driver DALI

BAJO PEDIDO / ON REQUEST / SUR COMMANDE / A PEDIDO

K

3.000K

5.000K

PCAmbar/PCAmbar/PCAmbar/  
PCAmbar/PCAmbre/PCAmber  
(I≤700mA)



5N

# Benzine Élite

## Superficie

- CI
- GO / IP65
- IK08
- L90B10> 200,000h
- 30~+35°C

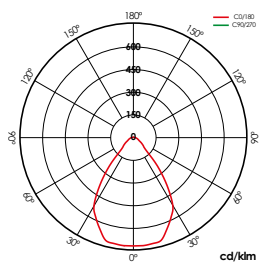
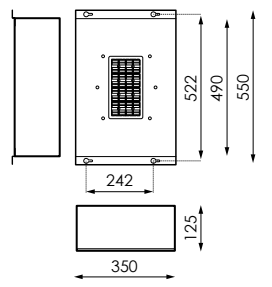
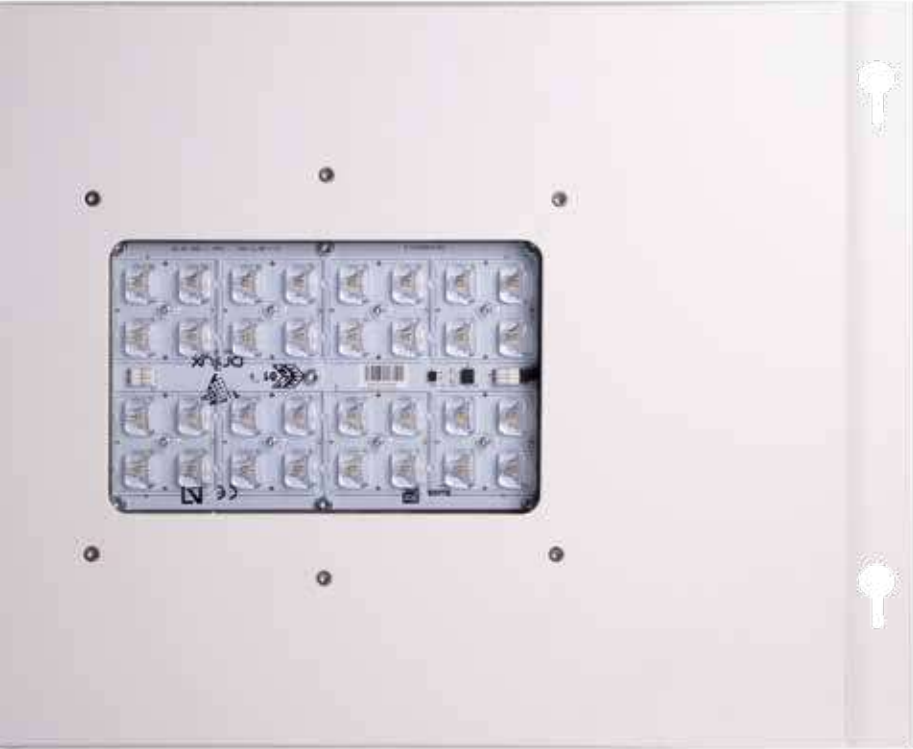

S069L0P

[GRÁFICOS: Unidades en mm/ GRAPHSICS: Units in mm/GRAPHIQUES: Unités en mm/GRÁFICOS: Unidades em mm]



⚡ 220-240V

Hz 50-60Hz

Φ >0.9

🌿 >70

K 4.000K

☀️ S069L0P

☀️ 0.0%

💡 32

🔗 BL

📏 VT

📦 FE

📦 15kg

⚡ Overstorm

🛡️ Systemshield

🕒 DN/LM

↑ Empotrar



MADE IN SPAIN  
Desing by PRILUX



491679

W<sub>LED</sub>

96W

W<sub>T</sub>

97W



1.000mA

Φ<sub>LED</sub>

14.893lm

Φ<sub>T</sub>

13.033lm

BAJO PEDIDO / ON REQUEST / SUR COMMANDE / A PEDIDO

K

3.000K

5.000K

PCAmbar/PCAmbar/PCAmbar/  
PCAmbar/PCAmbre/PCAmber  
(I≤700mA)



5N

Soluciones  
Solutions  
Des solutions  
Soluções

Cora Industry  
Pág. 34



Necesita driver DALI  
You need DALI driver  
Vous avez besoin d'un driver DALI  
Você precisa da driver DALI

# Accesorios

Accessories

Accessoires

Acessórios

	Berlin Avant			Benzine Elite Empotrar
	600mm	1.200mm	1.500mm	
378369	.			
378376		.		
378406			.	
493994				.



378369 INC. 6ud

Kit 6 clips plástico 600mm  
Kit 6 plastic clips 600mm  
Kit 6 clips en plastique 600mm  
Kit 6 cliques de plástico de 600mm



378376 INC. 8ud

Kit 8 clips plástico 1.200mm  
Kit 8 plastic clips 1.200mm  
Kit 8 clips en plastique 1.200mm  
Kit 8 cliques de plástico de 1.200mm



378406 INC. 10ud

Kit 10 clips plástico 1.500mm  
Kit 10 plastic clips 1.500mm  
Kit 10 clips en plastique 1.500mm  
Kit 10 cliques de plástico de 1.500mm



493994 INC. 1ud

Marco Benzine Élite  
Frame Benzine Élite  
Cadre Benzine Élite  
Quadro Benzine Élite

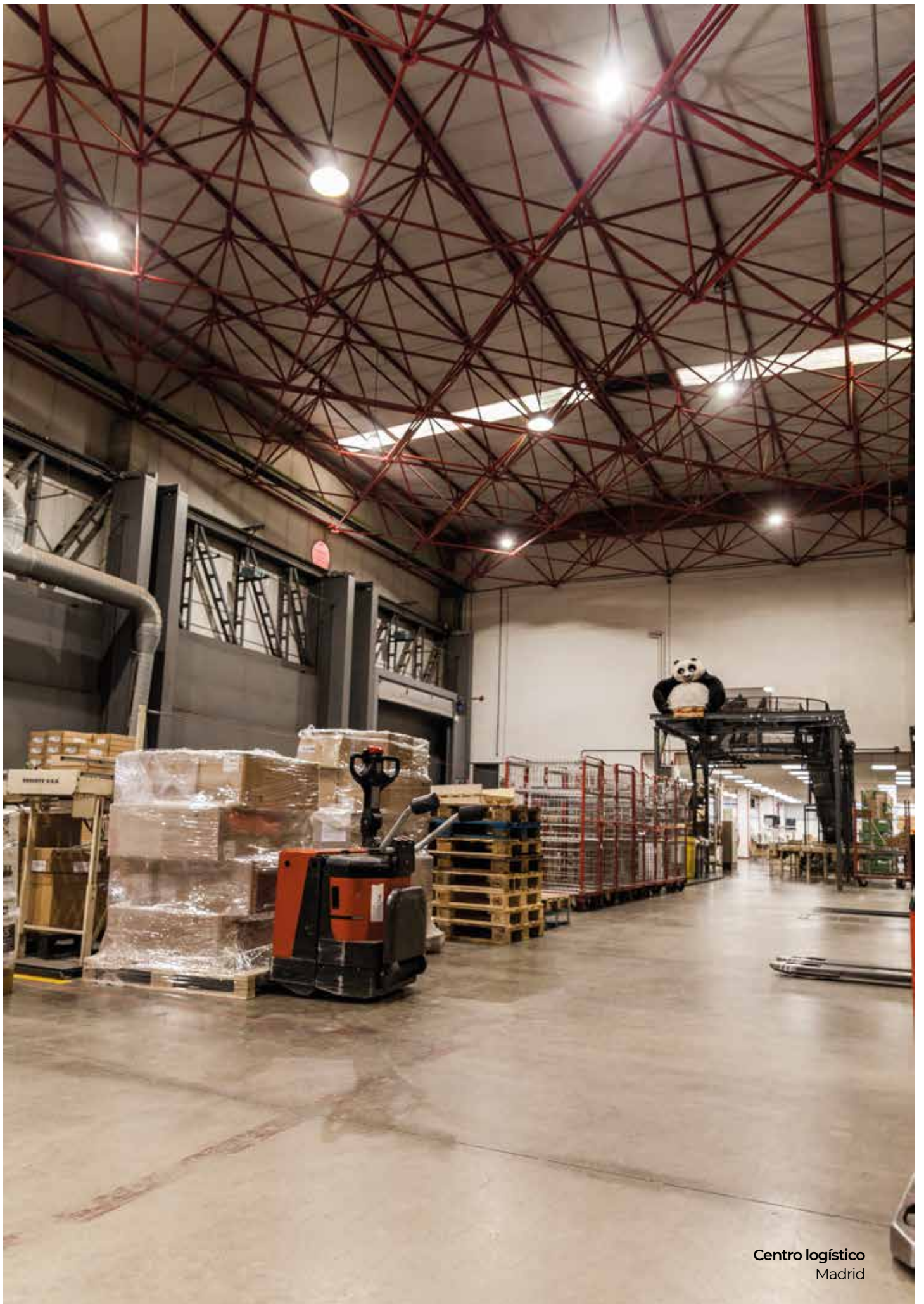

Centro logístico  
Madrid







# Realizaciones

Realizations

Réalisations

Realizações





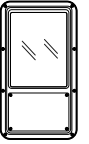





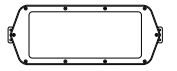

Hexagon Zenit







Berlin Avant





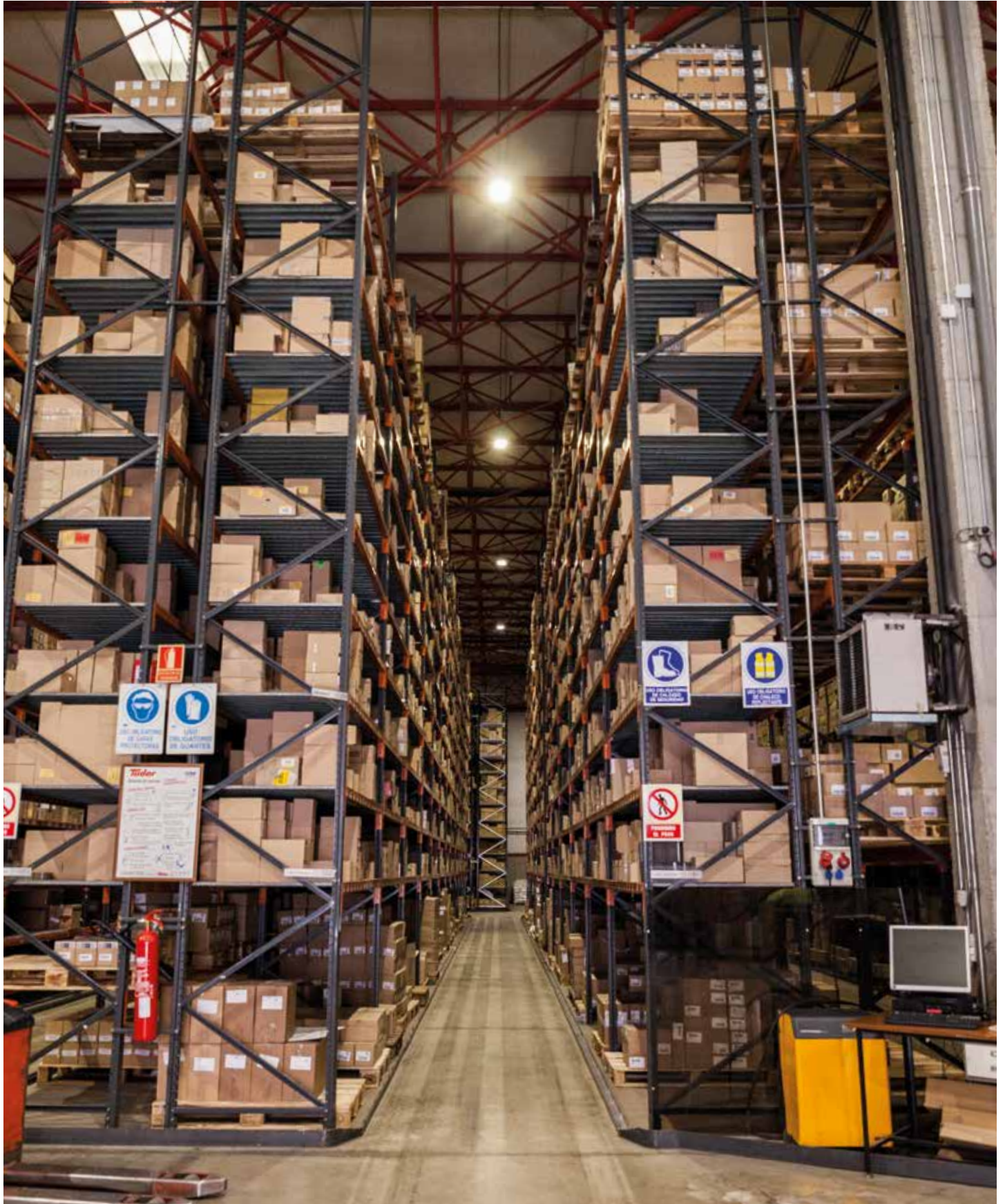







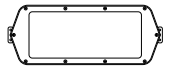

Hexagon Zenit









TELEFONIA Y ANEXO DE LA FEDERACION www.ihf.info

Callaghan

IBERDROLA

helvetia

WWW.IHKINFO

Santander

COMUNIDAD AUTONOMA DE MADRID

IBERDROLA

IBERDROLA

IBERDROLA



# Projection

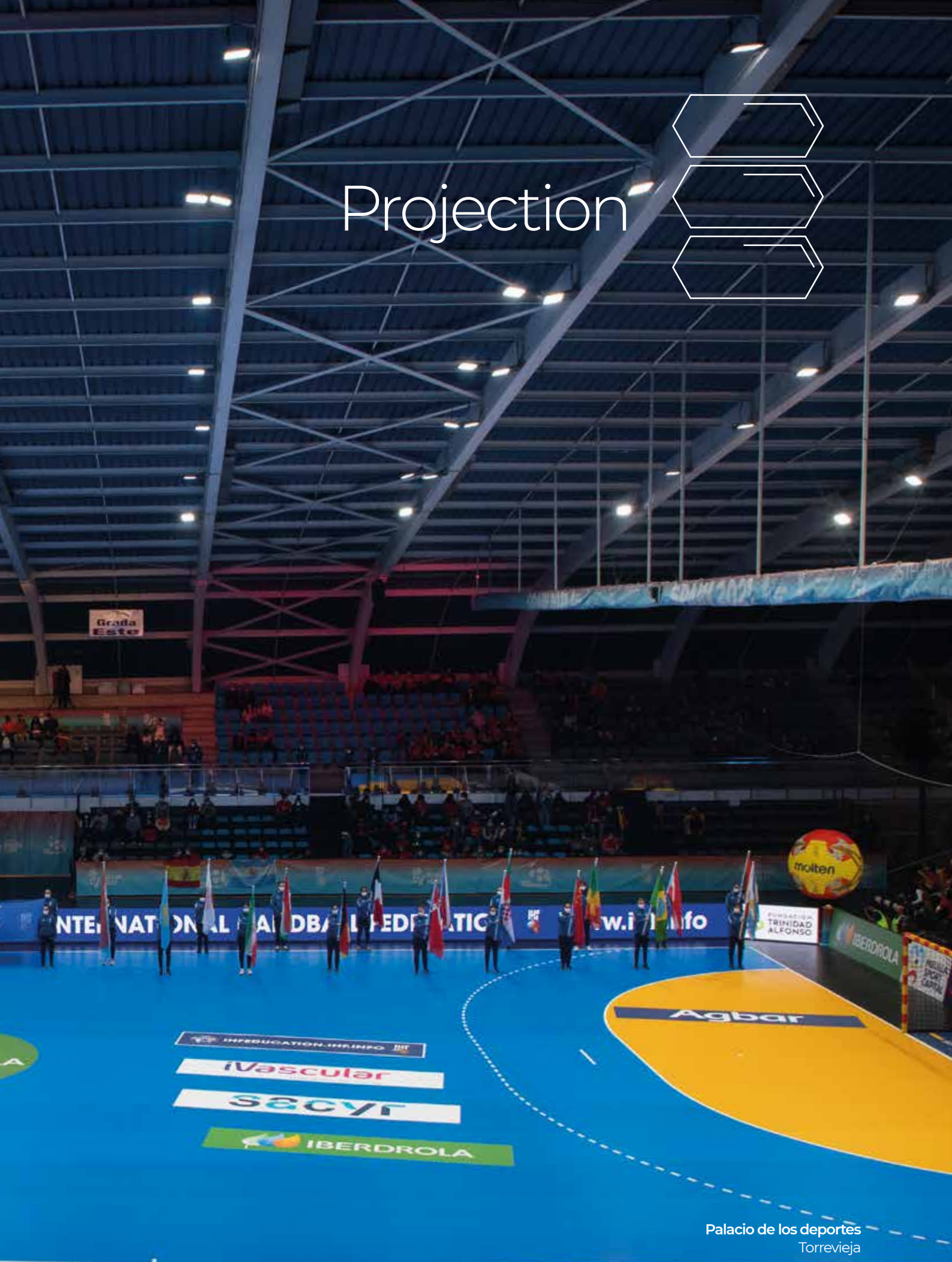

Palacio de los deportes  
Torrevieja



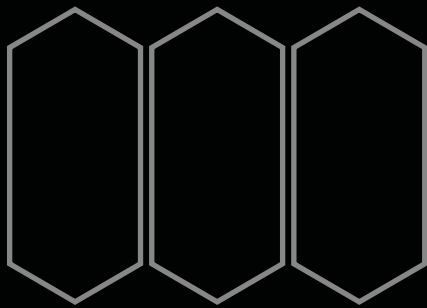

Hexagon  
Play





# Hexagon PLAY

**N/** HEXAGON PLAY es la familia de proyectores modulares de última generación diseñado por PRILUX para grandes espacios con altos requerimientos técnicos que, asociado al sistema de control CORA ofrece ahorros energéticos superiores al 70%.

Su diseño compacto basado en grupos ópticos combinables, de hasta 5 módulos, dotan a la luminaria de gran flexibilidad para adaptarse a las características de los diferentes proyectos lumínicos.

Además, son compatibles con nuestros sistemas de control y regulación CORA de gestión en remoto.

**E/** HEXAGON PLAY is the family of state-of-the-art modular projectors designed by PRILUX for large spaces with high technical requirements that, associated with the CORA control system, offer energy savings of over 70%.

Its compact design based on combinable optical groups, with up to 5 modules, give the luminaire great flexibility to adapt to the characteristics of different lighting projects.

In addition, they are compatible with our remote management CORA control and regulation systems.

**F/** HEXAGON PLAY est la famille de projecteurs modulaires de dernière génération conçue par PRILUX pour les grands espaces aux exigences techniques élevées qui, associés au système de contrôle CORA, permettent des économies d'énergie supérieures au 70 %.







Leur conception compacte basé sur des groupes optiques combinables, de maximum 5 plélines LED, munissent au luminaire d'une grande flexibilité et lui permet de s'adapter aux caractéristiques des différents projets d'éclairage.

Ils sont aussi compatibles avec nos systèmes de contrôle CORA

**P/** HEXAGON PLAY é a família de projetores modulares de última geração desenhados pela PRILUX para grandes espaços com elevados requisitos técnicos que, associados ao sistema de controlo CORA, oferecem poupanças energéticas superiores a 70%.

O seu design compacto baseado em grupos óticos combináveis, de até 5 módulos, confere à luminária uma grande flexibilidade para se adaptar às características dos diferentes projetos lumínicos.

Além disso, são compatíveis com os nossos sistemas de controlo e regulação CORA de gestão à distância.

Essential	Óptima		Was		Match Unity	Match	Arena 4K
1X	1X 2X 3X 4X 5X		1X 2X		2X	2X 3X 4X	2X 3X 4X
Driver Integrado	Box Integrado		Box Integrado		Box Integrado	Box Remoto	Box Remoto
S055I2P	AEXL0M	S028L0M	S033L0M	S014L0M	S030I2P	S030I2P	S026I2P
S025I2P	AINL0M	S068L0M	AINTL0M	S069L0M	S060I2P	S060I2P	S026I2P
S090I2P	PINL0M	SI34L0M	AEXTL0M	SI38L0M	S090I2P	S020I2P	S037I2P
S /LENTE	PEXL0M	SI52L0M	PINTL0M	SI50L0M	S020I2P	S090I2P	S090I2P
-	S016L0M	-	PEXTL0M	-	-	-	-
Ra ≥70 / 4.000K	Ra ≥70 / 4.000K	ROJO I≤700mA (620-625mm)	Ra≥70 / 4.000K		Ra ≥70 / 4.000K	Ra ≥70 / 4.000K	Ra≥90 / 6.000K
Ra≥70 / 3.000K	Ra≥70 / 3.000K	VERDE I≤700mA (520-535mm)	PCAmbar/ PCAmbar/ PCAmbré/ PCAmber		Ra≥70 / 5.000K	Ra ≥70 / 5.000K	-
Ra≥70 / 5.000K	Ra≥70 / 5.000K	AZUL I≤700mA (465-480mm)	-		Ra≥70 / 3.000K	Ra≥70 / 3.000K	-
-	-	-	-		Ra≥80 / 3.000K	Ra≥80 / 3.000K	-
-							
-	-	-	-		-	-	

## Tecnologías/ Technologies/ Technologies/ Tecnologias

+ INFO PAG. 21



De serie/ Serial/ De série/ Em série

playtech

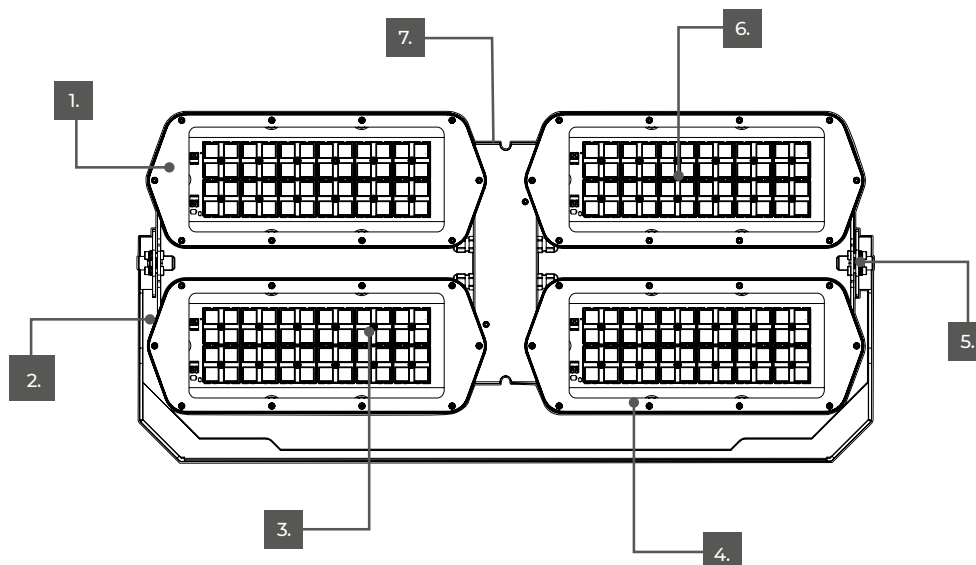

**Ñ**/ Cuerpo aluminio inyectado.  
**E**/ Die-cast aluminium body.  
**F**/ Corps en aluminium moulé sous pression.  
**P**/ Corpo em alumínio fundido sob pressão.

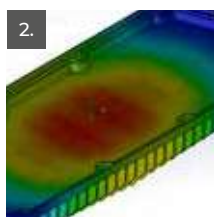

**Ñ**/ Disipación de calor.  
**E**/ Heat dissipation.  
**F**/ Dissipation de la chaleur.  
**P**/ Dissipação de calor.



**Ñ**/ Diversas Ópticas.  
**E**/ Diverse Optics.  
**F**/ Optiques diverses.  
**P**/ Várias Ópticas.



**Ñ**/ Cierre: Difusor de policarbonato con tratamiento UV.  
**E**/ Closure: Polycarbonate diffuser with UV-treatment.  
**F**/ Fermeture: Diffuseur en polycarbonate avec traitement UV.  
**P**/ Fechamento: Difusor em policarbonato com tratamento UV.

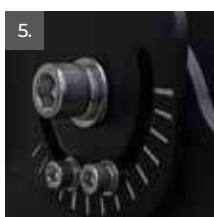

**Ñ**/ Instalación: Ajustable.  
**E**/ Installation: Adjustable.  
**F**/ Installation: Réglable.  
**P**/ Instalação: Ajustável.



**Ñ**/ Nivel de deslumbramiento controlado y alta uniformidad.  
**E**/ Controlled glare level and high uniformity.  
**F**/ Niveau d'éblouissement contrôlé et uniformité élevée.  
**P**/ Nível de brilho controlado e alta uniformidade.



**Ñ**/ Box Integrado o Box Remoto.  
**E**/ Integrated Box or Remote Box.  
**F**/ Boîte intégrée ou boîte à distance.  
**P**/ Caixa Integrada ou Caixa Remota.

# Hexagon

## PLAY

### Box remoto/ Box remoto

**N**/ Los proyectores provistos de box remoto permiten la instalación a distancias de hasta 80m, lo que permite fijar los proyectores a grandes alturas, sobre torretas, aleros, cubiertas y estructuras, y agrupar por otro lado los boxes en espacios en niveles fácilmente accesibles para el instalador o personal de mantenimiento.

**E**/ The projectors equipped with a remote box allow installation at distances of up to 80m, which allows the projectors to be fixed at great heights, on turrets, eaves, roofs and structures, and on the other hand to group the boxes in spaces on levels easily accessible to the installer or maintenance staff.

**F**/ Les projecteurs munis d'un box déporté contenant l'appareillage électrique permettent son installation jusqu' à une distance de 80m, ce qui permet d'installer les projecteurs à grande hauteur sur des mats, plafonds et autres structures et grouper, d'un autre cot les box dans des endroits facilement accessibles par l'installateur.

**P**/ Os projetores equipados com box remota permitem a instalação a distâncias de até 80 m, o que permite fixar os projetores a grandes alturas, sobre torres, beirais, coberturas e estruturas, e agrupar por outro lado as boxes em espaços em níveis facilmente acessíveis para o instalador ou pessoal de manutenção.

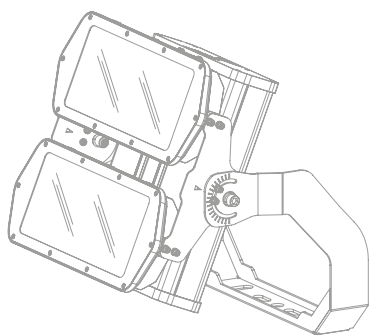

Box Integrado/  
Integrated Box/  
Box Intégré/  
Box Integrado/

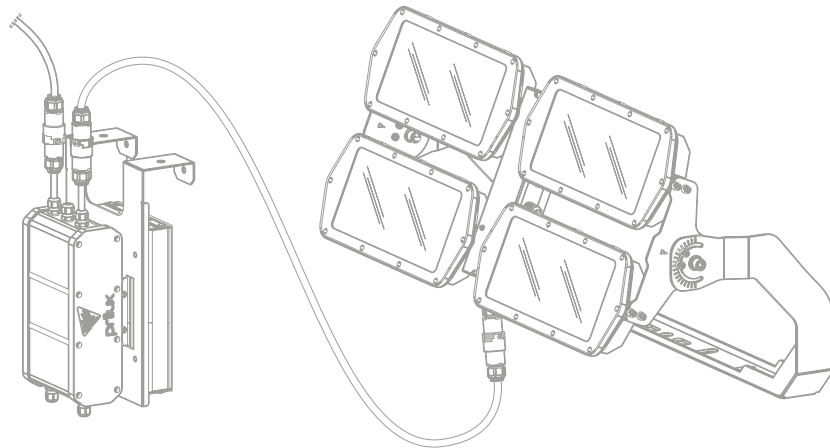

Box Remoto/  
Remote Box/  
Box Déporté/  
Box Remoto/

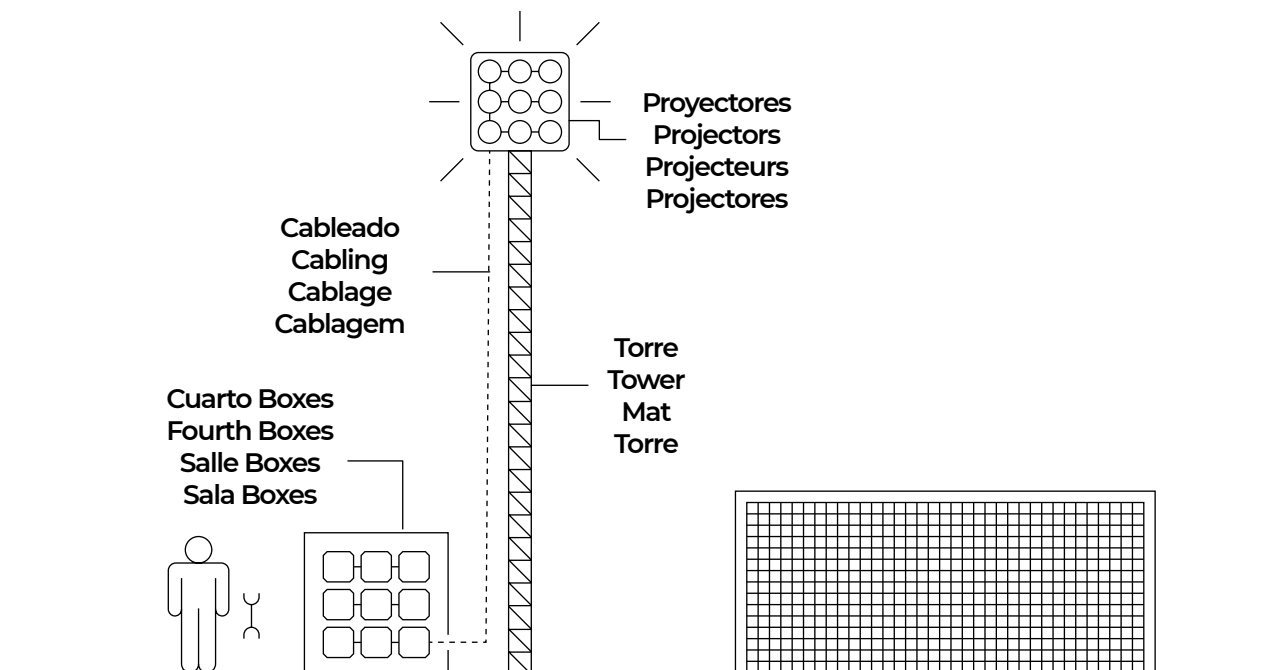

**Fácil mantenimiento/  
Facile maintenance  
Simplicidade na  
manutenção/**

**Ñ/** Las instalaciones provistas con box remoto permiten un mantenimiento más rápido y sencillo al encontrarse en niveles muy accesibles para el personal de mantenimiento.

**E/** The facilities provided with a remote box allow faster and easier maintenance as they are located at levels that are very accessible to maintenance personnel.

**F/** Les installations munies de box déportés permettent une maintenance plus rapide et simple, en plaçant ces derniers dans des endroits facilement accessibles.

**P/** As instalações fornecidas com box remota permitem uma manutenção mais rápida e simples ao estarem colocadas em zonas facilmente acessíveis.



**Mantenimiento seguro/  
Installations sécurisées/  
Instalações seguras/**

**Ñ/** Al estar los boxes centralizados en espacios a niveles accesibles se evita exponer a los operarios de mantenimiento a grandes alturas con los riesgos que ello acarrea.

**E/** As the boxes are centralized in spaces at accessible levels, it avoids exposing maintenance workers to great heights with the risks that this entails.

**F/** L'installation du box déporté facilite un niveau de sécurité supplémentaire pour les installateurs, en évitant les travaux de maintenance en grandes hauteurs tout en allégeant le poids du luminaire.

**P/** A instalação da box à distância proporciona uma maior segurança para os operários ao evitar a manutenção a grandes alturas e aligeirar o peso das torres.

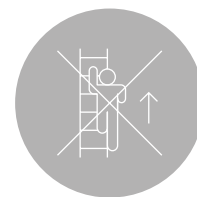

**Ahorro económico/  
Economies et efficience/  
Poupança económica e eficiência/**

**Ñ/** Posibilita el ahorro económico al no necesitar de medios auxiliares para acceder a los proyectores así como elementos de seguridad.

Reducción de los tiempos de mantenimiento al estar los boxes centralizados en un espacio.

**F/** Economies financières car il n'y a plus besoin d'utiliser des moyens auxiliaires, comme des grues, plateformes élévatrices en cas de réparations.

Réduction des temps de maintenance car les box sont centralisés dans un seul espace.

**E/** It enables economic savings by not needing auxiliary means to access the projectors as well as security elements.

Reduction of maintenance times as the boxes are centralized in one space.

**P/** Poupança económica ao não exigir meios auxiliares como gruas telescópicas ou plataformas elevatórias em caso de incidente.

Redução dos tempos de manutenção, pois as caixas são centralizadas em um único espaço.



# Hexagon PLAY



**Ñ**/ Proyector compacto de gran rendimiento lumínico y potencia contenida. Ideal para instalaciones industriales y deportivas con requerimientos lumínicos básicos. (ej. Pistas deportivas recreativas).

**E**/ Compact projector with great light output and contained power. Ideal for industrial and sports facilities with basic lighting requirements. (eg recreational sports courts).

## HEXAGON PLAY ESSENTIAL

**F**/ Projecteur compact à haut rendement lumineux et puissance modérée. Idéal pour les installations industrielles et sportives aux exigences lumineuses basiques. (Par ex. terrains de sport de loisir).

**P**/ Projetor compacto de elevado rendimiento lumínico e potência contida. Ideal para instalações desportivas com requisitos lumínicos básicos. (Ex: Recintos desportivos recreativas).



**Ñ**/ Proyector de hasta 720W de potencia, ideal para aplicaciones donde la solución lumínica requiere el uso de asimetrías y ópticas especiales. (ej. Espacios deportivos de cualquier nivel con montajes a menor altura que la ideal, naves industriales dedicadas al almacenaje en pasillos, espacios con altas restricciones de emisión al hemisferio superior).

**E**/ Projector with up to 720W of power, ideal for applications where the lighting solution requires the use of asymmetries and special optics. (eg sports spaces of any level with assemblies at a lower height than the ideal, industrial warehouses dedicated to storage in corridors, spaces with high emission restrictions to the upper hemisphere).

## HEXAGON PLAY ÓPTIMA

**F**/ Projecteur dont la puissance peut aller jusqu' à 720W, parfait pour les applications où la solution lumineuse exige l'utilisation d'asymétries et d'optiques spéciales. (Par ex. espaces sportifs de tout niveau, avec des montages à une hauteur inférieure à la hauteur idéale).

**P**/ Projetor de até 720W de potência, ideal para aplicações em que a solução lumínica exige a utilização de assimetrias e óticas especiais. (Ex: Espaços desportivos de qualquer nível com montagens a uma altura inferior à ideal).



**Ñ**/ Proyector con cambio dinámico de temperatura de color, perfecto para ambientes donde deseamos influir en los estados de ánimo, sensaciones y mejorar el bienestar del ocupante. (ej. Naves industriales, pabellones polidesportivos).

**E**/ Projector with dynamic color temperature change, perfect for environments where we want to influence moods, sensations and improve the well-being of the occupant. (eg industrial buildings, sports halls).

## HEXAGON PLAY WAS

**F**/ Projecteur à changement dynamique de température de couleur, parfait pour créer des ambiances où l'on souhaite réaliser une influence sur les états d'esprit, les sensations et améliorer le bien-être des utilisateurs. (Par ex. salles omnisports).

**P**/ Projetor com alteração dinâmica de temperatura de cor, perfeito para ambientes em que se pretenda influir nos estados de espírito, sensações e melhorar o bem-estar do utilizador. (Ex: Pavilhões polidesportivos).



## HEXAGON PLAY MATCH UNITY

**Ñ/** Solución integrada de hasta 500W pensada en pequeños espacios deportivos con un alto requerimiento lumínico donde la fuente lumínica y el equipo electrónico deben permanecer juntos. (ej. Pistas de tenis, pistas de pádel).

**E/** Integrated solution of up to 500W designed for small sports spaces with a high lighting requirement where the light source and the electronic equipment must remain together. (eg tennis courts, paddle tennis courts).

**F/** Solution intégrée allant jusqu'à 500 W, pensée pour les petits espaces sportifs aux exigences lumineuses élevées, où la source lumineuse et l'équipement électronique doivent se trouver au même endroit. (Par ex. courts de tennis, terrains de pádel).

**P/** Solução integrada de até 500W projetada para pequenos espaços esportivos com alta necessidade de iluminação onde a fonte de luz e o equipamento eletrônico devem permanecer juntos. (por exemplo, campos de ténis, campos de pádel).



## HEXAGON PLAY MATCH

**Ñ/** Máximas prestaciones lumínicas con gran durabilidad y robustez. Ideal para espacios deportivos de gran tamaño o donde los requerimientos lumínicos sean muy exigentes. (ej. Campos de fútbol clase I y clase II, polideportivo clase I, grandes espacios abiertos)

**E/** Maximum light performance with great durability and robustness. Ideal for large sports spaces or where lighting requirements are very demanding. (eg, class I and class II soccer fields, class I sports center, large open spaces)

**F/** Prestations lumineuses maximales, alliées à une grande durabilité et robustesse. Parfait pour les espaces sportifs aux grandes dimensions ou bien où les exigences lumineuses sont très élevées. (Par ex. Stades de football, salle omnisports, grands espaces ouverts)

**P/** Máximas prestações lumínicas com grande durabilidade e robustez. Ideal para espaços desportivos de grandes dimensões ou em que os requisitos lumínicos sejam muito exigentes. (Ex: Campos de futebol classe I e classe II, polidesportivo classe I, grandes espaços abertos)



## HEXAGON PLAY ARENA

**Ñ/** Proyector de máximas prestaciones pensado para la retransmisión televisiva. Con una consistencia cromática top en el mercado y llegando a flujos lumínicos pensados para grandes eventos de clase mundial.

**E/** High-performance projector designed for broadcasting television. With a top chromatic consistency in the market and reaching luminous fluxes designed for large world-class events.

**F/** Projecteur aux prestations maximales, pensé pour la retransmission télévisée. Avec le rendu chromatique plus élevée du marché et des flux lumineux pensés pour des grands événements d'envergure internationale.

**P/** Projetor de máximas prestações pensado para a transmissão televisiva. Garante uma reprodução cromática fiel à realidade e atinge fluxos lumínicos pensados para grandes eventos de competições profissionais.

# Hexagon

## Play Essential

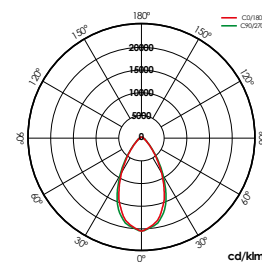
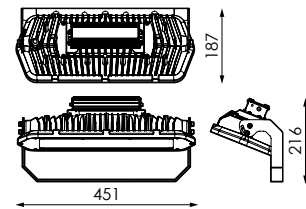

S055I2P

### ACCESORIOS / ACCESSOIRES / ACCESSORIES / ACESSÓRIOS

+ INFO PAG. 226

**N** 541855 INC. 1ud

Conector Enchufable IP66 3P  
IP66 3P Plug-in Connector  
Connecteur enfichable IP66 3P  
Conector de encaixe IP66 3P

**N** 524292 INC. 1ud

SPD Con Manguera  
SPD With Hose  
SPD avec tuyau  
SPD com Mangueira



⚡ 220-240V

Hz 50-60Hz

☀️ S055I2P

🌿 >70

K 4.000K

☀️ 0.0%

💡 144

🌀 RAL 9007

📐 PC-T

📦 AL iap

🏋️ 5,2kg

🛡️ TESS



MADE IN SPAIN  
Desing by PRILUX



📊	$W_{LED}$	$W_T$	🔌	$\phi$	$\phi_{LED}$	$\phi_T$	$\phi/W$	🌡️
561440	90W	97W	630mA	0,97	14.522lm	13.418lm	138m/W	-30°C~+50 °C
520362	145W	159W	1.000mA	0,98	21.198lm	19.587lm	123lm/W	-30°C~+50 °C
520355	180W	192W	1.200mA	0,99	24.183lm	22.291lm	116lm/W	-30°C~+45 °C

BAJO PEDIDO / ON REQUEST / SUR COMMANDE / A PEDIDO

🌿	K	☀️
Ra ≥70	3000K	S025I2P
	5000K	S090I2P
		Sin lente/ Without lens/ Sans objectif/ Sem lente/



# Hexagon

## Play Óptima

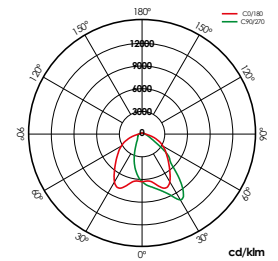

1X/2X AEXL0M

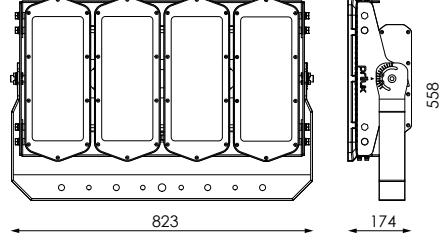
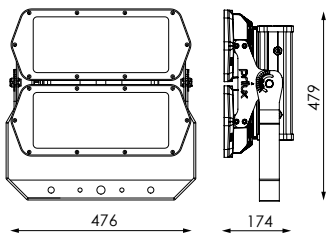
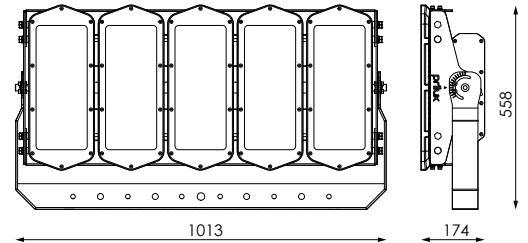
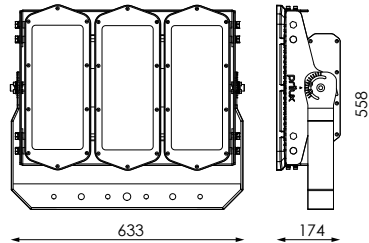
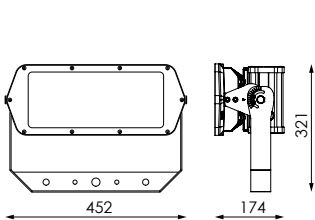

1X	460 x 343 x 174mm		8,8kg	0,082m <sup>2</sup>
2X	476 x 479 x 174mm		16,0kg	0,169m <sup>2</sup>
3X	633 x 558 x 174mm		26,0kg	0,261m <sup>2</sup>
4X	823 x 558 x 174mm		32,5kg	0,352m <sup>2</sup>
5X	1013 x 558 x 174mm		42,0kg	0,434m <sup>2</sup>

### ACCESORIOS / ACCESSOIRES / ACCESSORIES / ACESSÓRIOS

+ INFO PAG. 226

452311 INC. 1ud

Aletas móveis 1X  
Mobile fins 1X  
Palmes mobiles 1X  
Palas orientáveis 1X

452328 INC. 1ud

Aletas móveis 5X  
Mobile fins 5X  
Palmes mobiles 5X  
Palas orientáveis 5X

452335 INC. 1ud

Visera 1X  
Visor 1X  
Visière 1X  
Viseira 1X

452342 INC. 1ud

Visera 5X  
Visor 5X  
Visière 5X  
Viseira 5X

[GRÁFICOS: Unidades en mm/GRAPHIQUES: Units in mm/GRAPHIQUES: Units en mm/GRÁFICOS: Unidades em mm]

⚡ 220-240V

Hz 50-60Hz

☀️ AEXLOM

🌿 >70

K 4.000K

☀️ 0.0%

🌀 RAL 9007

📄 PC

📱 AL iap

⚡ Overstorm

🛡️ Systemshield

🛡️ HCB

🛡️ TESS

🌀 DALI



MADE IN SPAIN  
Desing by PRILUX



📏	🔍	W <sub>LED</sub>	W <sub>T</sub>	📏	φ <sub>LED</sub>	φ <sub>T</sub>	φ/W	☀️
467988	1X	144W	150W	1.000mA	21.737lm	17.403lm	116lm/W	48
467995	2X	288W	300W	1.000mA	43.474lm	34.806lm	116lm/W	96
468008	3X	432W	450W	1000mA	65.211lm	52.011lm	116lm/W	144
468015	4X	576W	600W	1.000mA	86.948lm	69.348lm	116lm/W	192
468022	5X	720W	750W	1.000mA	108.685lm	86.685lm	116lm/W	240

BAJO PEDIDO / ON REQUEST / SUR COMMANDE / A PEDIDO



K



Ra ≥70

3000K

AINLOM S028LOM

5000K

PINLOM S068LOM

ROJO ≤700mA (620-625mm)

PEXLOM S134LOM

VERDE ≤700mA (520-535mm)

S016LOM S152LOM

AZUL ≤700mA (465-480mm)

Soluciones  
Solutions  
Des solutions  
Soluções

Cora Sport  
Pág. 42

Cora Industry Lite  
Pág. 34

# Hexagon

## Play WAS

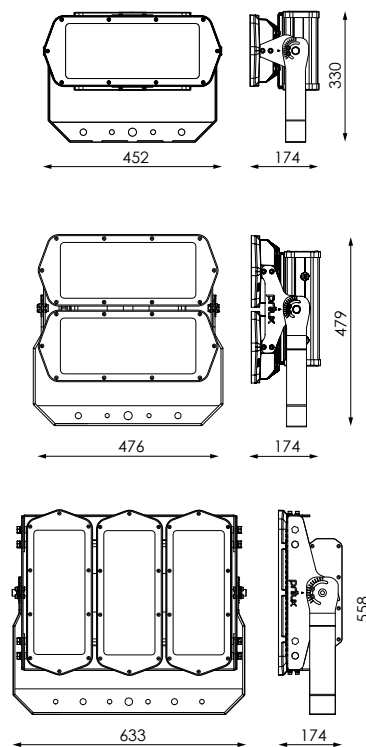

	↕	↔	⚖	📏
1X	460 x 343 x 174mm	9,0kg	0,082m <sup>2</sup>	
2X	476 x 479 x 174mm	17,0kg	0,169m <sup>2</sup>	
3X	633 x 558 x 174mm	29,0kg	0,261m <sup>2</sup>	

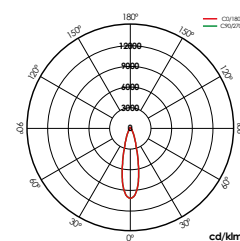

ACCESORIOS / ACCESSOIRES / ACCESSORIES / ACESSÓRIOS  
+ INFO PAG. 226

452311 INC. 1ud

Aletas móveis 1X  
Mobile fins 1X  
Palmes mobiles 1X  
Palas orientáveis 1X

452335 INC. 1ud

Visera 1X  
Visor 1X  
Visière 1X  
Viseira 1X

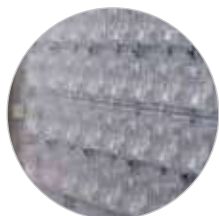

⚡ 220-240V

Hz 50-60Hz

☀️ S033LOM

🌿 >70

☀️ 0.0%

⊙ RAL 9007

🔪 PC-T

📄 ALiap

⚡ Overstorm

🛡️ HCB

🛡️ TESS



MADE IN SPAIN  
Desing by PRILUX



📊	🔍	W <sub>LED</sub>	W <sub>T</sub>	🔌	K	φ <sub>LED</sub>	φ <sub>T</sub>	☀️
501118	1X	60W	65W	1000mA	4.000K	8.695lm	7.906lm	20
		40W	46W	700mA	PCAmbar	3.232lm	2.939lm	20
501125	2X	120W	130W	1000mA	4.000K	17.390lm	15.812lm	40
		80W	92W	700mA	PCAmbar	6.464lm	5.878lm	40
501132	3X	180W	195W	1000mA	4.000K	26.085lm	23.178lm	60
		120W	138W	700mA	PCAmbar	9.696lm	8.817lm	60

BAJO PEDIDO / ON REQUEST / SUR COMMANDE / A PEDIDO



AINLOM	S014LOM
AEXLOM	S069LOM
PINLOM	S138LOM
PEXLOM	S150LOM



# Hexagon

## Play Match Unity

 CI	 IP66	 GO / IK09	 L90B10> 200.000h L95B10> 100.000h	 -30~+40°C
--	---	--	---	--

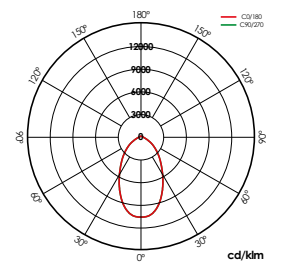
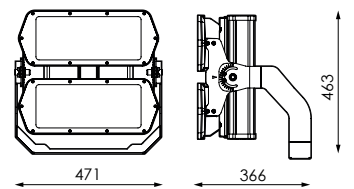

S060I2P

[GRÁFICOS: Unidades em mm/ GRAPHICS: Units in mm/GRAPHIQUES: Unités en mm/GRÁFICOS: Unidades em mm]

⚡ 220-240V

Hz 50-60Hz

🌿 >70

☀️ 0,0%

💡 288

🌀 RAL 9007

🔧 VT-T

📄 AL iap

📦 20kg

📏 0,169m<sup>2</sup>

⚡ Overstorm

🛡️ Systemshield

🛡️ HCB

🛡️ TESS



MADE IN SPAIN  
Desing by PRILUX



Barcode	W <sub>LED</sub>	W <sub>T</sub>	🔧	K	ϕ <sub>LED</sub>	ϕ <sub>T</sub>	ϕ/W	☀️	🌀
524087	500W	546W	3.800mA	4.000K	82.050lm	70.964lm	130lm/W	S030I2P	DALI
524100	500W	546W	3.800mA	4.000K	82.050lm	69.599lm	127lm/W	S060I2P	DALI
561846	500W	546W	3.800mA	4.000K	82.050lm	69.380lm	127lm/W	S090I2P	DALI
524124	500W	546W	3.800mA	5.000K	82.050lm	70.964lm	130lm/W	S030I2P	DALI
524148	500W	546W	3.800mA	5.000K	82.050lm	69.599lm	127lm/W	S060I2P	DALI
561860	500W	546W	3.800mA	5.000K	82.050lm	69.380lm	127lm/W	S090I2P	DALI
524070	500W	546W	3.800mA	4.000K	82.050lm	70.964lm	130lm/W	S030I2P	NO
524094	500W	546W	3.800mA	4.000K	82.050lm	69.599lm	127lm/W	S060I2P	NO
561877	500W	546W	3.800mA	4.000K	82.050lm	69.380lm	127lm/W	S090I2P	NO
524117	500W	546W	3.800mA	5.000K	82.050lm	70.964lm	130lm/W	S030I2P	NO
524131	500W	546W	3.800mA	5.000K	82.050lm	69.599lm	127lm/W	S060I2P	NO
561952	500W	546W	3.800mA	5.000K	82.050lm	69.380lm	127lm/W	S090I2P	NO

BAJO PEDIDO / ON REQUEST / SUR COMMANDE / A PEDIDO

🌿	K	🔧	☀️
Ra>70	3.000K	PC-T (IK10)	S020I2P
Ra>80	3.000K		

Soluciones  
Solutions  
Des solutions  
Soluções

Cora Sport  
Pág. 42

Cora Industry Lite  
Pág. 34



Necesita driver DALI  
You need DALI driver  
Vous avez besoin d'un driver DALI  
Você precisa da driver DALI

# Hexagon

Play Match / Arena







# Hexagon

## Play Match / Arena

**Ñ/** Diseñamos soluciones para las competiciones deportivas más exigentes y para los grandes estadios de uso profesional.

La iluminación artificial tiene un impacto directo sobre la calidad de la imagen en televisión y en consecuencia sobre la percepción visual. Los eventos deportivos no solo deben tener en cuenta los requisitos lumínicos imprescindibles que exige la norma para llevar a cabo las actividades, sino que ha de cumplir las condiciones visuales específicas para la retransmisión televisiva si es requerida.

La iluminación del estadio debe permitir que la retransmisión del evento cumpla con un alto estándar de calidad digital. HEXAGON ARENA es la luminaria perfecta para adaptarse a los estándares y normas de retransmisión televisiva por las federaciones deportivas. Proporciona una iluminación óptima para la retransmisión en 4K ya que maximiza el resultado de la imagen. Con un TLCl >94 (índice de consistencia de la iluminación de la televisión), garantiza una reproducción cromática fiel a la realidad.

**E/** Diseñamos soluciones para las competiciones deportivas más exigentes y para los grandes estadios de uso profesional.

La iluminación artificial tiene un impacto directo sobre la calidad de la imagen en televisión y en consecuencia sobre la percepción visual. Los eventos deportivos no solo deben tener en cuenta los requisitos lumínicos imprescindibles que exige la norma para llevar a cabo las actividades, sino que ha de cumplir las condiciones visuales específicas para la retransmisión televisiva si es requerida.

La iluminación del estadio debe permitir que la retransmisión del evento cumpla con un alto estándar de calidad digital. HEXAGON ARENA es la luminaria perfecta para adaptarse a los estándares y normas de retransmisión televisiva por las federaciones deportivas. Proporciona una iluminación óptima para la retransmisión en 4K ya que maximiza el resultado de la imagen. Con un TLCl >94 (índice de consistencia de la iluminación de la televisión), garantiza una reproducción cromática fiel a la realidad.

**F/** Diseñamos soluciones para las competiciones deportivas más exigentes y para los grandes estadios de uso profesional.

La iluminación artificial tiene un impacto directo sobre la calidad de la imagen en televisión y en consecuencia sobre la percepción visual. Los eventos deportivos no solo deben tener en cuenta los requisitos lumínicos imprescindibles que exige la norma para llevar a cabo las actividades, sino que ha de cumplir las condiciones visuales específicas para la retransmisión televisiva si es requerida.

La iluminación del estadio debe permitir que la retransmisión del evento cumpla con un alto estándar de calidad digital. HEXAGON ARENA es la luminaria perfecta para adaptarse a los estándares y normas de retransmisión televisiva por las federaciones deportivas. Proporciona una iluminación óptima para la retransmisión en 4K ya que maximiza el resultado de la imagen. Con un TLCl >94 (índice de consistencia de la iluminación de la televisión), garantiza una reproducción cromática fiel a la realidad.

**P/** Diseñamos soluciones para las competiciones deportivas más exigentes y para los grandes estadios de uso profesional.

La iluminación artificial tiene un impacto directo sobre la calidad de la imagen en televisión y en consecuencia sobre la percepción visual. Los eventos deportivos no solo deben tener en cuenta los requisitos lumínicos imprescindibles que exige la norma para llevar a cabo las actividades, sino que ha de cumplir las condiciones visuales específicas para la retransmisión televisiva si es requerida.

La iluminación del estadio debe permitir que la retransmisión del evento cumpla con un alto estándar de calidad digital. HEXAGON ARENA es la luminaria perfecta para adaptarse a los estándares y normas de retransmisión televisiva por las federaciones deportivas. Proporciona una iluminación óptima para la retransmisión en 4K ya que maximiza el resultado de la imagen. Con un TLCl >94 (índice de consistencia de la iluminación de la televisión), garantiza una reproducción cromática fiel a la realidad.



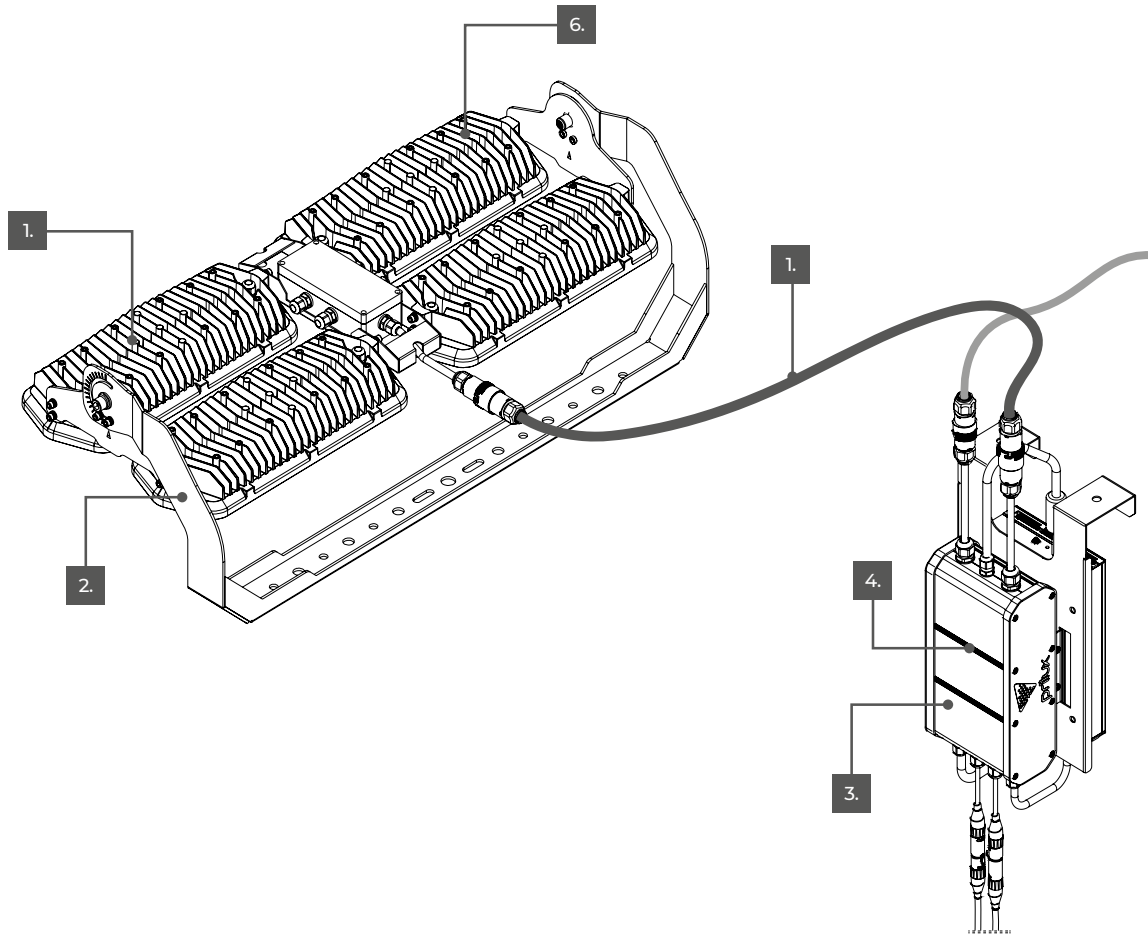

**Ñ/** Menor peso  
**E/** Less weight  
**F/** Moins de poids  
**P/** Menor peso

**Ñ/** Fijación PLAY  
**E/** PLAY Fixing  
**F/** PLAY Fixation  
**P/** Fixação PLAY

**Ñ/** Protector contra sobretensiones:  
**E/** Surge protector  
**F/** Protecteur de surtension  
**P/** Protetor de surto

**Ñ/** Aumenta la eficacia en la evacuación del calor:  
**E/** Increases the efficiency of heat evacuation  
**F/** Augmente l'efficacité de l'évacuation de la chaleur  
**P/** Aumenta a eficiência da evacuação de calor



**Ñ/** Hasta 80m (5G 1,5)  
**E/** Up to 80m (5G 1,5)  
**F/** Jusqu'à 80m (5G 1,5)  
**P/** Até 80m (5G 1,5)

**Ñ/** Disipación de calor:  
**E/** Heat dissipation  
**F/** Dissipation de la chaleur  
**P/** Dissipação de calor

# Hexagon

## Play Match / Arena

Combinaciones / Combinations / Combinaisons / Combinações

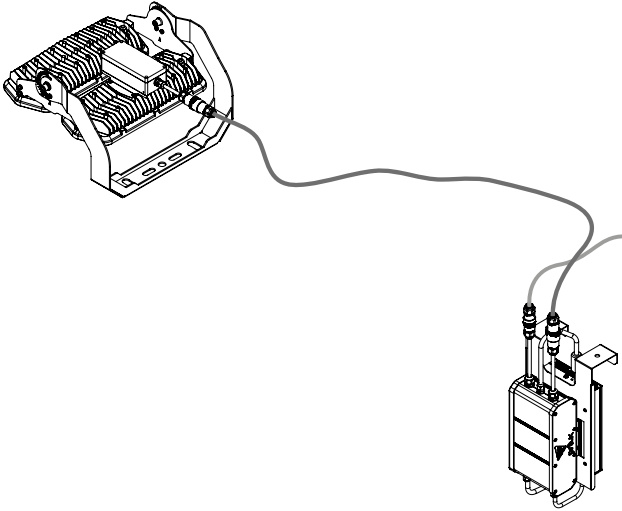

2X Match/ Arena  
Sin Regulación/ No Regulation/ Pas de règlement/ Sem regulamento  
DALI

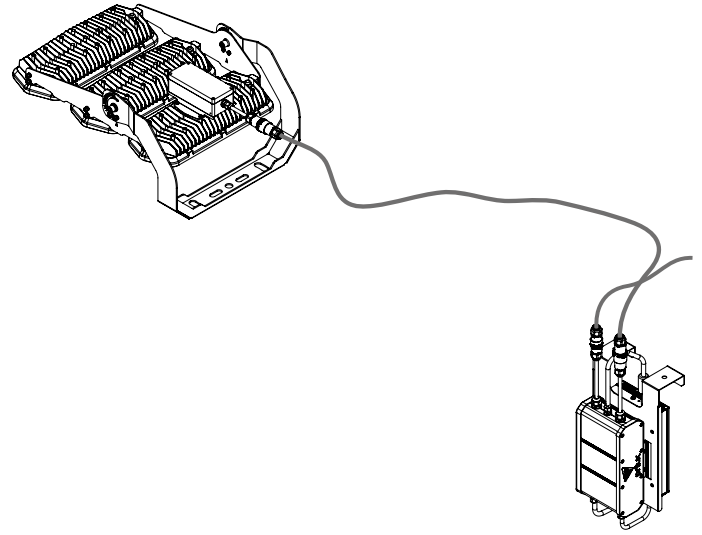

3X Match/ Arena  
Sin Regulación/ No Regulation/ Pas de règlement/ Sem regulamento  
DALI

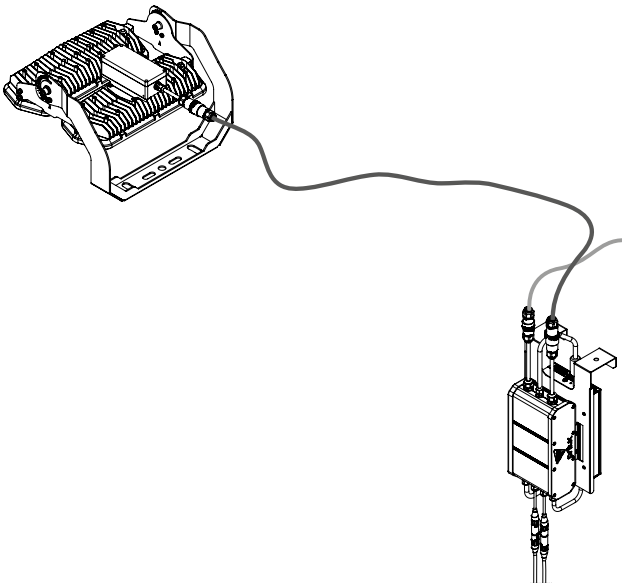

3X Arena  
DMX

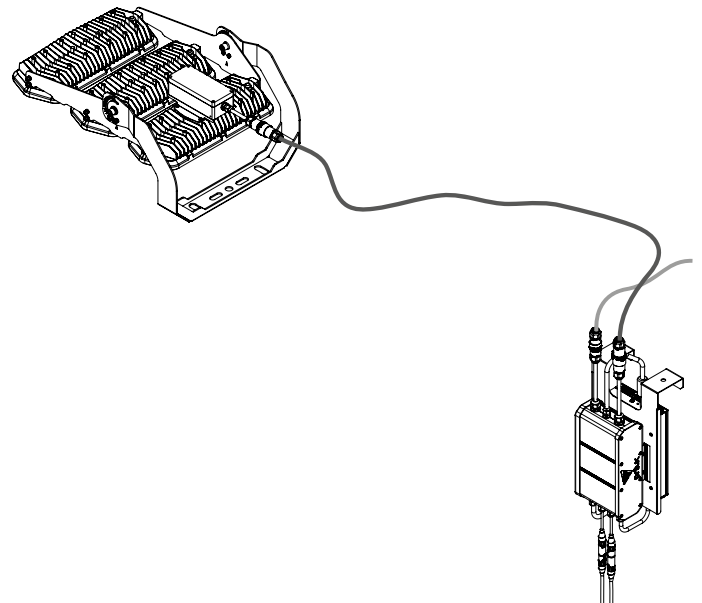

3X Arena  
DMX

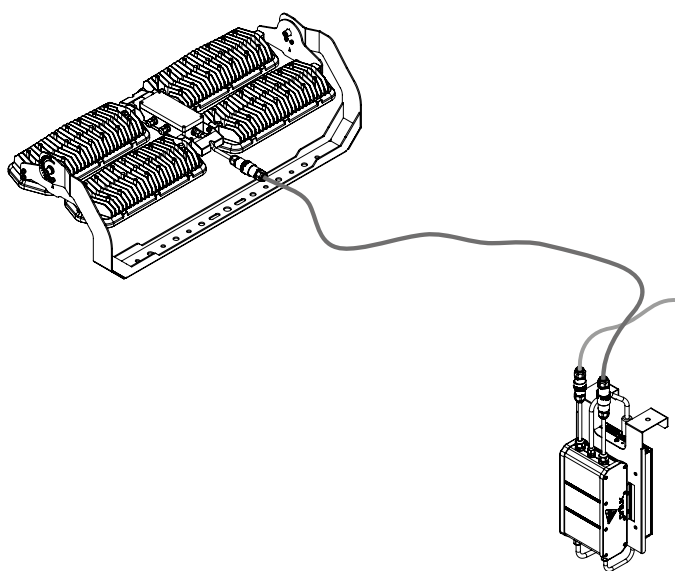

4X Match/ Arena 1.000W  
Sin Regulación/ No Regulation/ Pas de règlement/ Sem regulamento  
DALI

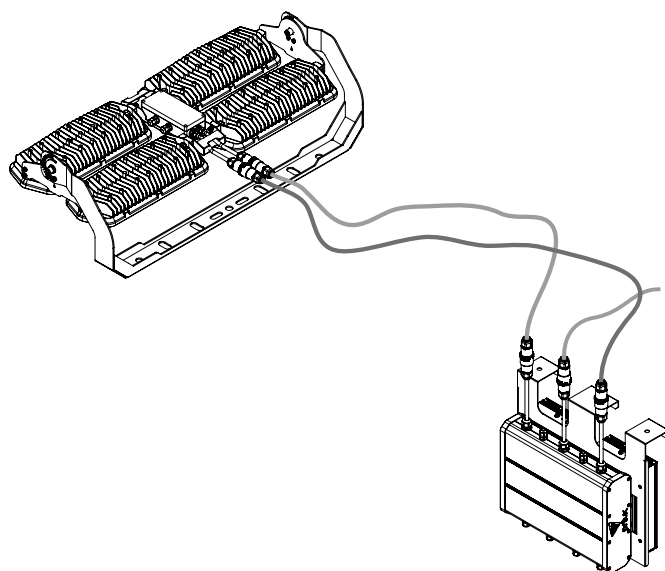

4X Match/ Arena 1.400W  
Sin Regulación/ No Regulation/ Pas de règlement/ Sem regulamento  
DALI

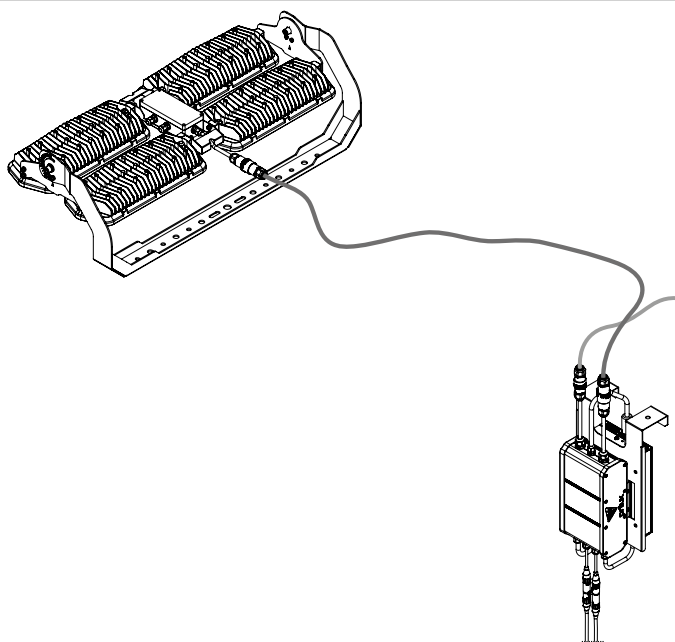

4X Arena 1.000W  
DMX

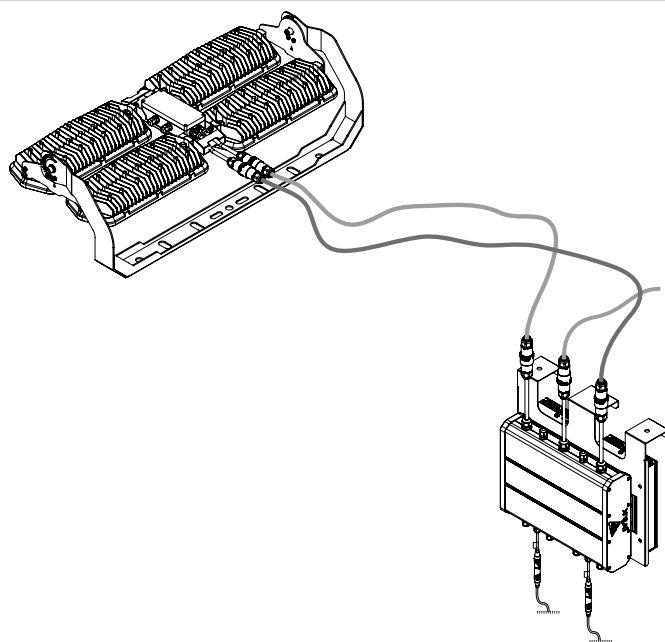

4X ARENA 1.400W  
DMX



# Hexagon

## Play Match



CI	IP66	GO / IK09	L90B10> 200,000h	-30~+35 °C (635 / 900 / 1,400W) -30~+40 °C (1,000W)
----	------	-----------	---------------------	--

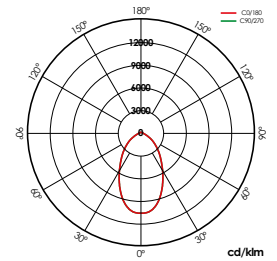
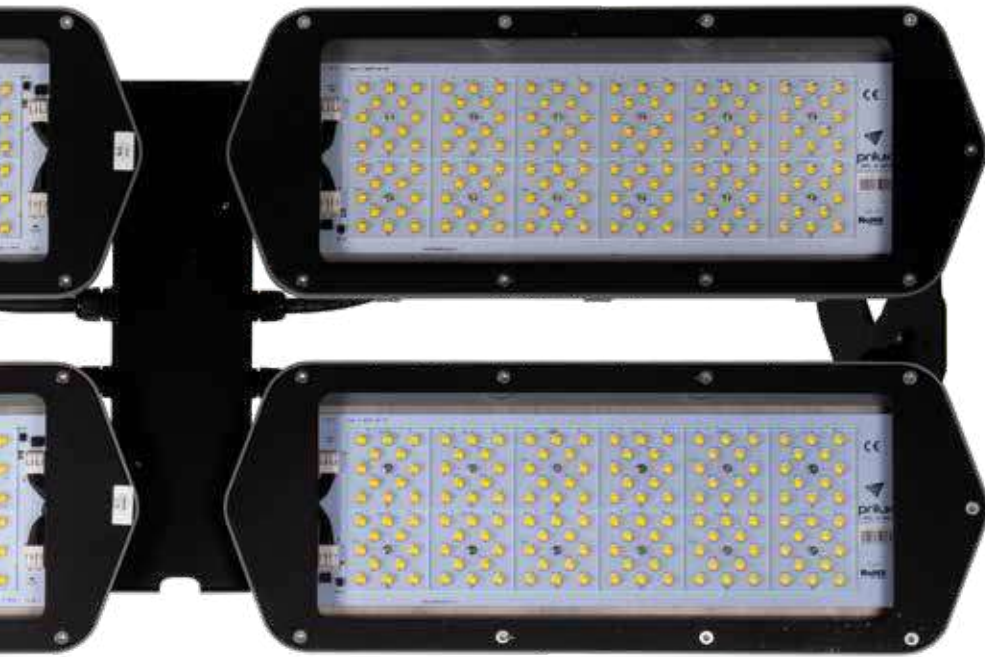

S060I2P

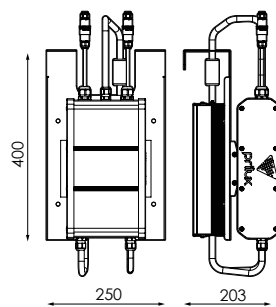
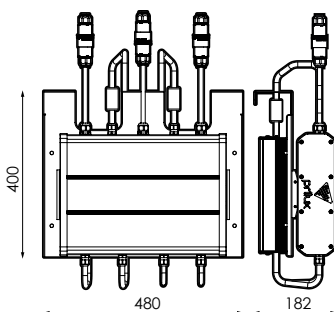
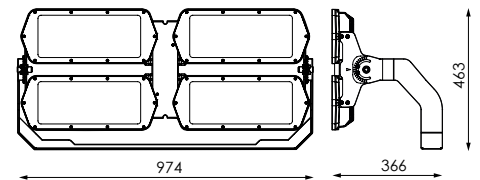
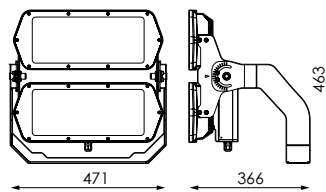
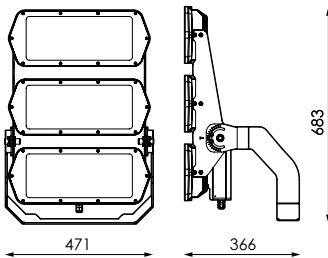

<b>G.O. HEXAGON</b>				
2X	471 x 463 x 366mm	13,5kg	0,169m <sup>2</sup>	
3X	471 x 683 x 366mm	18,5kg	0,261m <sup>2</sup>	
4X	974 x 463 x 366mm	26kg	0,352m <sup>2</sup>	
<b>BOX HEXAGON</b>				
1.000W	250 x 400 x 200mm	12,5kg	-	
1.400W	480 x 400 x 182mm	20kg	-	

⚡ 220-240V

Hz 50-60Hz

🌿 >70

☀️ 0.0%

🌀 RAL 9007

📏 VT

📄 AL iap

⚡ Overstorm

🛡️ Systemshield

🛡️ HCB

🛡️ TESS



MADE IN SPAIN  
Desing by PRILUX



	📏	W <sub>LED</sub>	W <sub>T</sub>	🔌	K	ϕ <sub>LED</sub>	ϕ <sub>T</sub>	ϕ/W	☀️	🌿	🌀
562201	2X	635W	688W	4.800mA	4.000K	97.689lm	84.470lm	123lm/W	288	S030I2P	DALI
562218	2X	635W	688W	4.800mA	4.000K	97.689lm	82.760lm	120lm/W	288	S060I2P	DALI
562232	2X	635W	688W	4.800mA	5.000K	97.689lm	84.470lm	123lm/W	288	S030I2P	DALI
562225	2X	635W	688W	4.800mA	5.000K	97.689lm	82.760lm	120lm/W	288	S060I2P	DALI
562164	2X	635W	688W	4.800mA	4.000K	97.689lm	84.470lm	123lm/W	288	S030I2P	-
562171	2X	635W	688W	4.800mA	4.000K	97.689lm	82.760lm	120lm/W	288	S060I2P	-
562188	2X	635W	688W	4.800mA	5.000K	97.689lm	84.470lm	123lm/W	288	S030I2P	-
562195	2X	635W	688W	4.800mA	5.000K	97.689lm	82.760lm	120lm/W	288	S060I2P	-
562300	3X	900W	977W	6.600mA	4.000K	140.190lm	121.182lm	124lm/W	432	S030I2P	DALI
562317	3X	900W	977W	6.600mA	4.000K	14.0190lm	118.758lm	122lm/W	432	S060I2P	DALI
562324	3X	900W	977W	6.600mA	5.000K	14.0190lm	121.182lm	124lm/W	432	S030I2P	DALI
562331	3X	900W	977W	6.600mA	5.000K	14.0190lm	118.758lm	122lm/W	432	S060I2P	DALI
562249	3X	900W	977W	6.600mA	4.000K	14.0190lm	121.182lm	124lm/W	432	S030I2P	-
562270	3X	900W	977W	6.600mA	4.000K	14.0190lm	118.758lm	122lm/W	432	S060I2P	-
562287	3X	900W	977W	6.600mA	5.000K	14.0190lm	121.182lm	124lm/W	432	S030I2P	-
562294	3X	900W	977W	6.600mA	5.000K	14.0190lm	118.758lm	122lm/W	432	S060I2P	-
499248**	4X	1.000W	1.090W	7.400mA	4.000K	171.522lm	147.528lm	135lm/W	576	S030I2P	DALI
486200**	4X	1.000W	1.090W	7.400mA	4.000K	171.522lm	146.518lm	134lm/W	576	S060I2P	DALI
491600**	4X	1.000W	1.090W	7.400mA	5.000K	171.522lm	147.528lm	135lm/W	576	S030I2P	DALI
499705**	4X	1.000W	1.090W	7.400mA	5.000K	171.522lm	146.518lm	134lm/W	576	S060I2P	DALI
499583**	4X	1.000W	1.090W	7.400mA	4.000K	171.522lm	147.528lm	135lm/W	576	S030I2P	-
499606**	4X	1.000W	1.090W	7.400mA	4.000K	171.522lm	146.518lm	134lm/W	576	S060I2P	-
499668**	4X	1.000W	1.090W	7.400mA	5.000K	171.522lm	147.528lm	135lm/W	576	S030I2P	-
478427**	4X	1.000W	1.090W	7.400mA	5.000K	171.522lm	146.518lm	134lm/W	576	S060I2P	-
499781**	4X	1.400W	1.520W	10.200mA	4.000K	219.400lm	188.713lm	124lm/W	576	S030I2P	DALI
499828**	4X	1.400W	1.520W	10.200mA	4.000K	219.400lm	187.940lm	124lm/W	576	S060I2P	DALI
499842**	4X	1.400W	1.520W	10.200mA	5.000K	219.400lm	188.713lm	124lm/W	576	S030I2P	DALI
499866**	4X	1.400W	1.520W	10.200mA	5.000K	219.400lm	187.940lm	124lm/W	576	S060I2P	DALI
499811**	4X	1.400W	1.520W	10.200mA	4.000K	219.400lm	188.713lm	124lm/W	576	S030I2P	-
499835**	4X	1.400W	1.520W	10.200mA	4.000K	219.400lm	187.940lm	124lm/W	576	S060I2P	-
499859**	4X	1.400W	1.520W	10.200mA	5.000K	219.400lm	188.713lm	124lm/W	576	S030I2P	-
499873**	4X	1.400W	1.520W	10.200mA	5.000K	219.400lm	187.940lm	124lm/W	576	S060I2P	-

BAJO PEDIDO / ON REQUEST / SUR COMMANDE / A PEDIDO

🌿	K	📏	☀️
Ra>70	3.000K	PC-T (IK10)	S020I2P
Ra>80	3.000K		S090I2P

Soluciones  
Solutions  
Des solutions  
Soluções

Cora Sport  
Pág. 42



Necesita driver DALI  
You need DALI driver  
Vous avez besoin d'un driver DALI  
Você precisa da driver DALI

# Hexagon

## Play Arena



CI	IP66	GO / IK09	L90B10> 200.000h	-30~+35 °C (635 / 900 / 1,400W) -30~+40 °C (1,000W)	<b>4K</b> 960
----	------	-----------	---------------------	--	------------------

**HD** Apto retransmisiones deportivas  
 Suitable sports broadcasts  
 Diffusions sportives appropriées  
 Transmissões esportivas adequadas

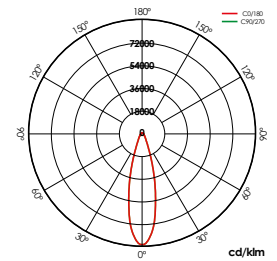

S026I2P

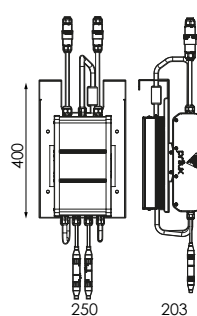
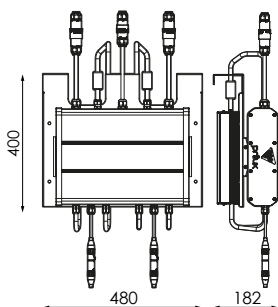
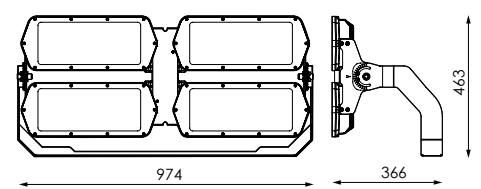
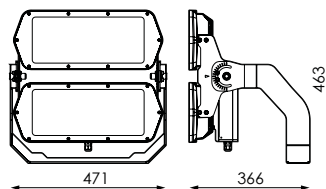
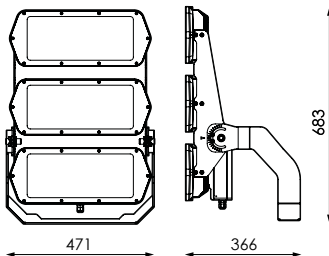

<b>G.O. HEXAGON</b>				
2X		471 x 463 x 366mm	13,5kg	0,169m <sup>2</sup>
3X		471 x 683 x 366mm	18,5kg	0,261m <sup>2</sup>
4X		974 x 463 x 366mm	26kg	0,352m <sup>2</sup>
<b>BOX HEXAGON</b>				
1.000W		250 x 400 x 200mm	12,5kg	-
1.400W		480 x 400 x 182mm	20kg	-

[GRÁFICOS: Unidades en mm/ GRAPHICS: Units in mm/GRÁFICOS: Unidades en mm/GRÁFICOS: Unidades en mm]

⚡ 220-240V

Hz 50-60Hz

🌿 >90

K 6.000K

TLCDI >94

🕒 95

☀️ 0.0%

🌀 RAL 9007

✍️ VT

📄 AL iap

⚡ Overstorm

🛡️ Systemshield

🛡️ HCB

🛡️ TESS



MADE IN SPAIN  
Desing by PRILUX



		⏏	W <sub>LED</sub>	W <sub>T</sub>	📏	ϕ <sub>LED</sub>	ϕ <sub>T</sub>	ϕ/W	☀️	🌿	🕒
574716	2X	635W	678W	4.800mA	85.302lm	73.957lm	109lm/W	288	S026I2P	DMX	
574723	2X	635W	678W	4.800mA	85.302lm	75.588lm	111lm/W	288	S066I2P	DMX	
574754	3X	900W	928W	6600mA	119.290lm	102.740lm	111lm/W	432	S026I2P	DMX	
574761	3X	900W	928W	6600mA	119.290lm	105.770lm	114lm/W	432	S066I2P	DMX	
474238**	4X	1.000W	1.070W	7.400mA	141.225lm	122.687lm	115lm/W	576	S026I2P	DMX	
499880**	4X	1.000W	1.070W	7.400mA	141.225lm	125.561lm	117lm/W	576	S066I2P	DMX	
499897**	4X	1.400W	1.500W	10.200mA	182.596lm	158.530lm	106lm/W	576	S026I2P	DMX	
499903**	4X	1.400W	1.500W	10.200mA	182.596lm	162.606lm	108lm/W	576	S066I2P	DMX	

BAJO PEDIDO / ON REQUEST / SUR COMMANDE / A PEDIDO

Soluciones  
Solutions  
Des solutions  
Soluções

Cora Sport  
Pág. 42



Necesita driver DALI  
You need DALI driver  
Vous avez besoin d'un driver DALI  
Você precisa da driver DALI



DALI



PC (IK10)



S037I2P

S090I2P





Nantes  
Play



# Nantes

## PLAY

**Ñ/** Cuenta con un diseño compacto y minimalista basado en líneas básicas y ángulos puros a la vez que elegantes. Su estética permite una integración en armonía con la arquitectura

Su diseño está pensado para disipar el calor alargando la vida del LED y favorecer la evacuación del agua evitando puntos de oxidación y facilitando así su autolimpieza.

El cuerpo, la tapa y la lira han sido fabricados en aluminio inyectado a alta presión de gran calidad que garantizan la durabilidad de la luminaria.

Descubre en su dossier todo lo relacionado con nuestra luminaria Nantes.

**E/** It has a compact and minimalist design. With basic lines and pure yet elegant angles, it blends harmoniously into the architecture.

It is designed to dissipate heat in order to extend the life of the LED, and facilitate the evacuation of water to prevent oxidation and ease self-cleaning.

The body and the cover are made of top quality, high-pressure injected aluminium to guarantee durability.

Find out everything about our Nantes luminaire in its dossier.

**F/** Elle possède un design compact et minimaliste basé sur des lignes simples et des angles purs et élégants. Son esthétique lui permet de s'intégrer harmonieusement à l'architecture

Son design est conçu pour dissiper la chaleur, prolongeant ainsi la durée de vie de la LED et pour favoriser l'évacuation de l'eau, évitant les points d'oxydation et facilitant l'autonettoyage.

Le corps, le couvercle et la lyre sont fabriqués en aluminium moulé par injection sous pression de haute qualité, ce qui garantit la durabilité du luminaire.

Découvrez dans son dossier tout ce qui concerne notre luminaire Nantes

**P/** Conta com um design compacto e minimalista, baseado em linhas básicas, e ângulos puros e, ao mesmo tempo, elegantes. A sua estética permite uma integração em harmonia com a arquitetura.

O seu design foi pensado para dissipar o calor, prolongando a vida do LED, e favorecer a evacuação da água, evitando pontos de oxidação e facilitando, assim, a sua autolimpieza.

A estrutura, a cobertura e a tira são fabricadas em alumínio injetado a alta pressão de grande qualidade, o que garante a durabilidade da luminária.

Descubra no seu dossier tudo o que está relacionado com a nossa luminária Nantes.



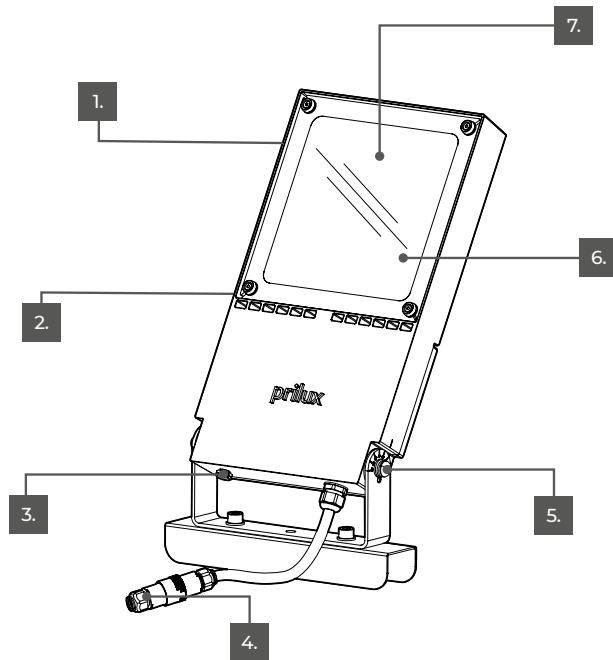

**Ñ/ Diseño:**  
Compacto y minimalista.

**E/ Design:**  
Compact and minimalist.

**F/ Conception:**  
Compact et minimaliste.

**P/ Projeto:**  
Compacto e minimalista.



**Ñ/ Conectividad:**  
NEMA 7 y ZHAGA BOOK 18

**E/ Connectivity:**  
NEMA 7 and ZHAGA BOOK 18

**F/ Connectivité:**  
NEMA 7 et ZHAGA BOO 18

**P/ Conectividade:**  
NEMA 7 e ZHAGA BOOK 18



**Ñ/ Válvula de presiones:**  
Para evitar la entrada de humedad.

**E/ Pressure valve**  
To prevent moisture ingress

**F/ Soupape de pression:**  
Pour éviter la pénétration d'humidité

**P/ Válvula de pressão:**  
Para evitar a entrada de umidade



**Ñ/ Instalación:**  
Bloque de conexión IP68.

**E/ Easy connection:**  
IP68 connection block.

**F/ Connexion facile:**  
Bloc de connexion IP68.

**P/ Conexão fácil:**  
Bloco de conexão IP68.



**Ñ/ Orientación:**  
Permite un giro de 0° a 180°.

**E/ nstallation:**  
It allows a rotation from 0° to 180°.

**F/ Installation:**  
Il permet une rotation de 0° à 180°.

**P/ Instalação:**  
Permite uma rotação de 0° a 180°.



**Ñ/ Vidrio templado:**  
5mm de espesor.

**E/ Tempered glass:**  
5mm thick.

**F/ Verre trempé:**  
5 mm d'épaisseur.

**P/ Vidro temperado:**  
5mm de espessura.



**Ñ/ Eficiencia:**  
Eficacias de 167lm/W.

**E/ Efficiency:**  
167lm/W efficiencies.

**F/ Efficacité:**  
Rendement 167lm/W.

**P/ Eficiência:**  
Eficiências de 167lm/W.



# Nantes

## PLAY



<b>N</b> NEW	CI	IP66	L / IK09 CO / IK10	L70B10> 100,000h	-30~+50°C
-----------------	----	------	-----------------------	---------------------	-----------

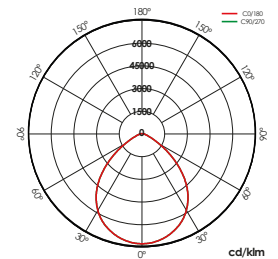
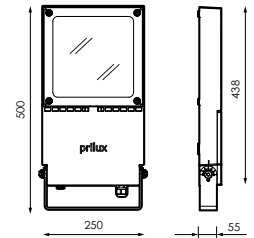
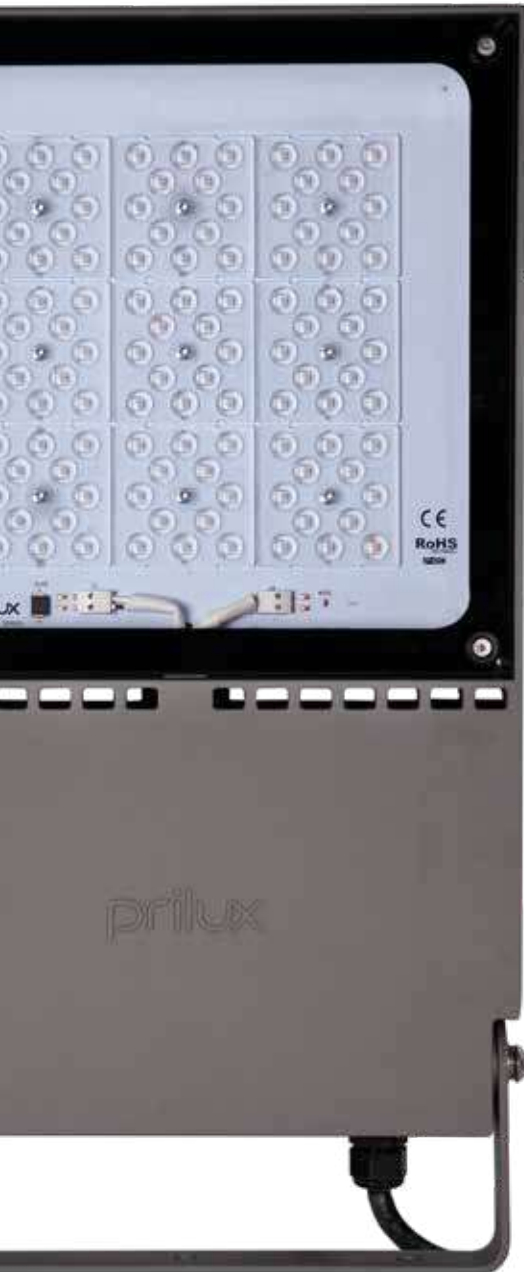

S09012P

ACCESORIOS / ACCESSOIRES / ACCESSORIES / ACESSÓRIOS  
+ INFO PAG. 226

**N** 515788

INC. 1ud

Visera  
Visor  
Visière  
Viseira

[GRÁFICOS: Unidades en mm/GRÁFICOS: Units in mm/GRAPHICS: Units en mm/GRÁFICOS: Unidades em mm]

⚡ 220-240V

Hz 50-60Hz

☀️ S090I2P

💡 108

🌿 >70

☀️ 0,0%

🌀 RAL 9007

📄 VT-T

📖 AL iap

📊 5,75kg

📏 0,11 m²

⚡ Overstorm

🛡️ Systemshield

🕒 DALI



MADE IN SPAIN  
Desing by PRILUX



Barcode	W <sub>LED</sub>	W <sub>T</sub>	⏏	K	Φ	Φ <sub>LED (Tj 25°C)</sub>	Φ <sub>LED</sub>	Φ <sub>T</sub>	Φ/W
575454	35W	38,0W	350mA	3.000K	0,93	7.064lm	6.695lm	5.825lm	153lm/W
519878	35W	38,0W	350mA	4.000K	0,93	7.348lm	7.207lm	6.270lm	165lm/W
575461	51W	55,1W	500mA	3.000K	0,96	9.762lm	9.294lm	8.086lm	147lm/W
519847	51W	55,1W	500mA	4.000K	0,96	10.153lm	10.005m	8.704lm	158lm/W
575485	73W	79,0W	700mA	3.000K	0,97	13.171lm	12.525lm	10.897lm	138lm/W
519892	73W	79,0W	700mA	4.000K	0,97	13.698lm	13.483lm	11.730lm	148lm/W
575478	110W	118,4W	1000mA	3.000K	0,98	17.881lm	16.839lm	14.650lm	124lm/W
519915	110W	118,4W	1000mA	4.000K	0,98	18.598lm	18.126lm	15.770lm	133lm/W

BAJO PEDIDO / ON REQUEST / SUR COMMANDE / A PEDIDO

K	⦿	☀️
Ra>70	5.000K	DN/LM
	2.200K	5N
Ra>80	2.700K	VAI2I2P
	3.000K	VAI1I2P
	4.000K	
Ra>90	5.000K	
📏	🌀	
CII	Disponibile colores RAL (Consultar) Available RAL colors (Consult) Couleurs RAL disponibles (Consulter) Cores RAL disponíveis (Consultar)	

Soluciones  
Solutions  
Des solutions  
Soluções

Cora Sport  
Pág. 42

# Nantes L

## PLAY



<b>N</b> NEW	CI	IP66	L / IK09 CO / IK10	L70B10 > 100,000h	-30~+50 °C (62 - 130W) -30~+40 °C (189W)
-----------------	----	------	-----------------------	----------------------	---

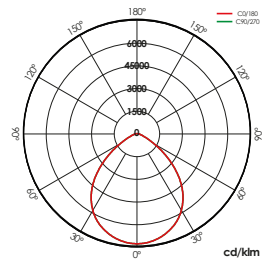
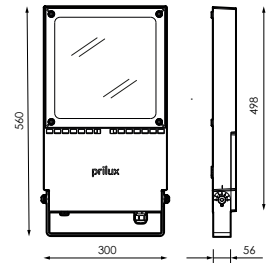

S090I2P

ACCESORIOS / ACCESSOIRES / ACCESSORIES / ACESSÓRIOS  
+ INFO PAG. 226

**N** 515818 INC. 1ud

Visera L  
L Visor  
Visière L  
Viseira L

[GRÁFICOS: Unidades en mm/GRAPHIQUES: Units in mm/GRAPHICS: Units in mm/GRÁFICOS: Unidades em mm]

⚡ 220-240V

Hz 50-60Hz

☀️ S090I2P

💡 192

🌿 >70

☀️ 0,0%

🌀 RAL 9007

📏 VT-T

📄 AL iap

📊 7,8kg

🏠 0,168m²

⚡ Overstorm

🛡️ Systemshield

🕒 DALI



MADE IN SPAIN  
Desing by PRILUX



Barcode	W <sub>LED</sub>	W <sub>T</sub>	📏	K	φ	φ <sub>LED (1) 25°C</sub>	φ <sub>LED</sub>	φ <sub>T</sub>	φ/W
575492	62W	68,8W	350mA	3.000K	0,95	12.565lm	11.906lm	10.358lm	151lm/W
519922	62W	68,8W	350mA	4.000K	0,95	13.069lm	12.977lm	11.290lm	164lm/W
571999	92W	98,3W	500mA	3.000K	0,97	17.355lm	16.615lm	14.455lm	147lm/W
520010	92W	98,3W	500mA	4.000K	0,97	18.239lm	18.110lm	15.756lm	160lm/W
575508	130W	137,6W	700mA	3.000K	0,98	23.413lm	22.051lm	19.184lm	139lm/W
520027	130W	137,6W	700mA	4.000K	0,98	24.350lm	24.034lm	20.910lm	152lm/W
575515	189W	203,7W	1.000mA	3.000K	0,97	31.798lm	29.000lm	25.230lm	124lm/W
520034	189W	203,7W	1.000mA	4.000K	0,97	33.070lm	31.609lm	27.500lm	135lm/W

BAJO PEDIDO / ON REQUEST / SUR COMMANDE / A PEDIDO

K	🕒	☀️
Ra>70	5.000K	DN/LM
	2.200K	5N
Ra>80	2.700K	VAI2I2P
	3.000K	VAI1I2P
	4.000K	
Ra>90	5.000K	
📏	🌀	
CII	Disponible colores RAL (Consultar) Available RAL colors (Consult) Couleurs RAL disponibles (Consulter) Cores RAL disponíveis (Consultar)	



# Nantes XL

## PLAY



<b>N</b> NEW	CI	IP66	L / IK09 CO / IK10	L70B10 >100.000h	-30~+50 °C (97 / 140 / 201W) -30~+35 °C (304W)
-----------------	----	------	-----------------------	---------------------	---

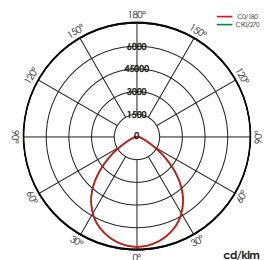
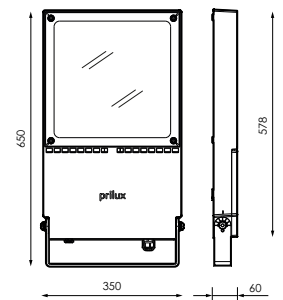
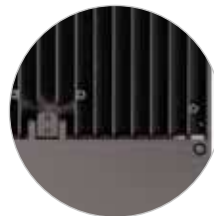

S090I2P

ACCESORIOS / ACCESSOIRES / ACCESSORIES / ACESSÓRIOS  
+ INFO PAG. 226

**N** 515832

INC. 1ud

Visera XL  
XL Visor  
Visière XL  
Viseira XL

[GRÁFICOS: Unidades en mm/GRÁFICOS: Units in mm/GRAPHIQUES: Unités en mm/GRÁFICOS: Unidades em mm]

⚡ 220-240V

Hz 50-60Hz

☀️ S090I2P

💡 192

🌿 >70

☀️ 0,0%

🌀 RAL 9007

📏 VT-T

📄 AL iap

📊 11,5kg

🏠 0,200m²

⚡ Overstorm

🛡️ Systemshield

🕒 DALI



MADE IN SPAIN  
Desing by PRILUX



Barcode	W <sub>LED</sub>	W <sub>T</sub>	🔌	K	φ	φ <sub>LED (1) 25°C</sub>	φ <sub>LED</sub>	φ <sub>T</sub>	φ/W
575522	97W	104,0W	350mA	3.000K	0,97	19.654lm	18.436lm	15.966lm	154lm/W
520041	97W	104,0W	350mA	4.000K	0,97	20.420lm	20.042lm	17.340lm	167lm/W
575546	140W	149,9W	500mA	3.000K	0,96	27.004lm	25.331lm	21.937lm	146lm/W
520058	140W	149,9W	500mA	4.000K	0,96	28.203lm	27.538lm	23.826lm	159lm/W
575539	201W	215,9W	700mA	3.000K	0,97	36.928lm	34.129lm	29.556lm	137lm/W
520065	201W	215,9W	700mA	4.000K	0,97	38.047lm	37.101lm	32.100lm	149lm/W
566681	304W	324,1W	1.000mA	3.000K	0,98	47.815lm	45.612lm	39.500lm	122lm/W
520072	304W	324,1W	1.000mA	4.000K	0,98	51.672lm	49.584lm	42.900lm	132lm/W

BAJO PEDIDO / ON REQUEST / SUR COMMANDE / A PEDIDO

K	🕒	☀️
Ra>70	5.000K	DN/LM
	2.200K	5N
Ra>80	2.700K	VAI2I2P
	3.000K	VAI1I2P
	4.000K	
Ra>90	5.000K	
📄	🌀	
CII	Disponible colores RAL (Consultar) Available RAL colors (Consult) Couleurs RAL disponibles (Consulter) Cores RAL disponíveis (Consultar)	

Soluciones  
Solutions  
Des solutions  
Soluções

Cora Sport  
Pág. 42

# Accesorios

Accessories

Accessoires

Acessórios

	Hexagon Play Essential	Hexagon Óptima	Nantes Play	Nantes Play L	Nantes Play XL
452311	.	.			
452328		.			
452335	.	.			
452342		.			
515788			.		
515818				.	
515832					.



**N** 541855

INC. 1ud

Conector Enchufable IP66 3P  
IP66 3P Plug-in Connector  
Connecteur enfichable IP66 3P  
Conector de encaixe IP66 3P



**N** 524292

INC. 1ud

SPD Con Manguera  
SPD With Hose  
SPD avec tuyau  
SPD com Mangueira



452311

INC. 1ud

Aletas móveis 1X  
Mobile fins 1X  
Palmes mobiles 1X  
Palas orientáveis 1X



452328

INC. 1ud

Aletas móveis 5X  
Mobile fins 5X  
Palmes mobiles 5X  
Palas orientáveis 5X



452335

INC. 1ud

Visera 1X  
Visor 1X  
Visière 1X  
Viseira 1X



452342

INC. 1ud

Visera 5X  
Visor 5X  
Visière 5X  
Viseira 5X



**N** 515788

INC. 1ud

Visera  
Visor  
Visière  
Viseira



**N** 515818

INC. 1ud

Visera L  
L Visor  
Visière L  
Viseira L



**N** 515832

INC. 1ud

Visera XL  
XL Visor  
Visière XL  
Viseira XL







# Realizaciones

Realizations

Réalisations

Realizações



Petrel  
Alicante



Proyecto de Iluminación  
Petrel  
Alicante

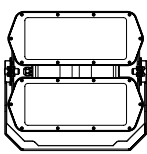

Hexagon Play

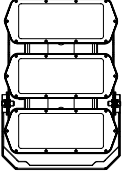

Hexagon Play







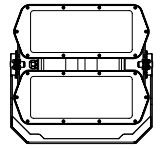

Hexagon Play







Proyecto de Iluminación  
Chapinería  
Madrid

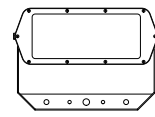

Hexagon Play

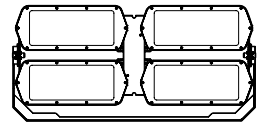

Hexagon Play Match







Proyecto de Iluminación  
Hellín  
Albacete







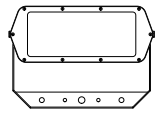

Hexagon Play

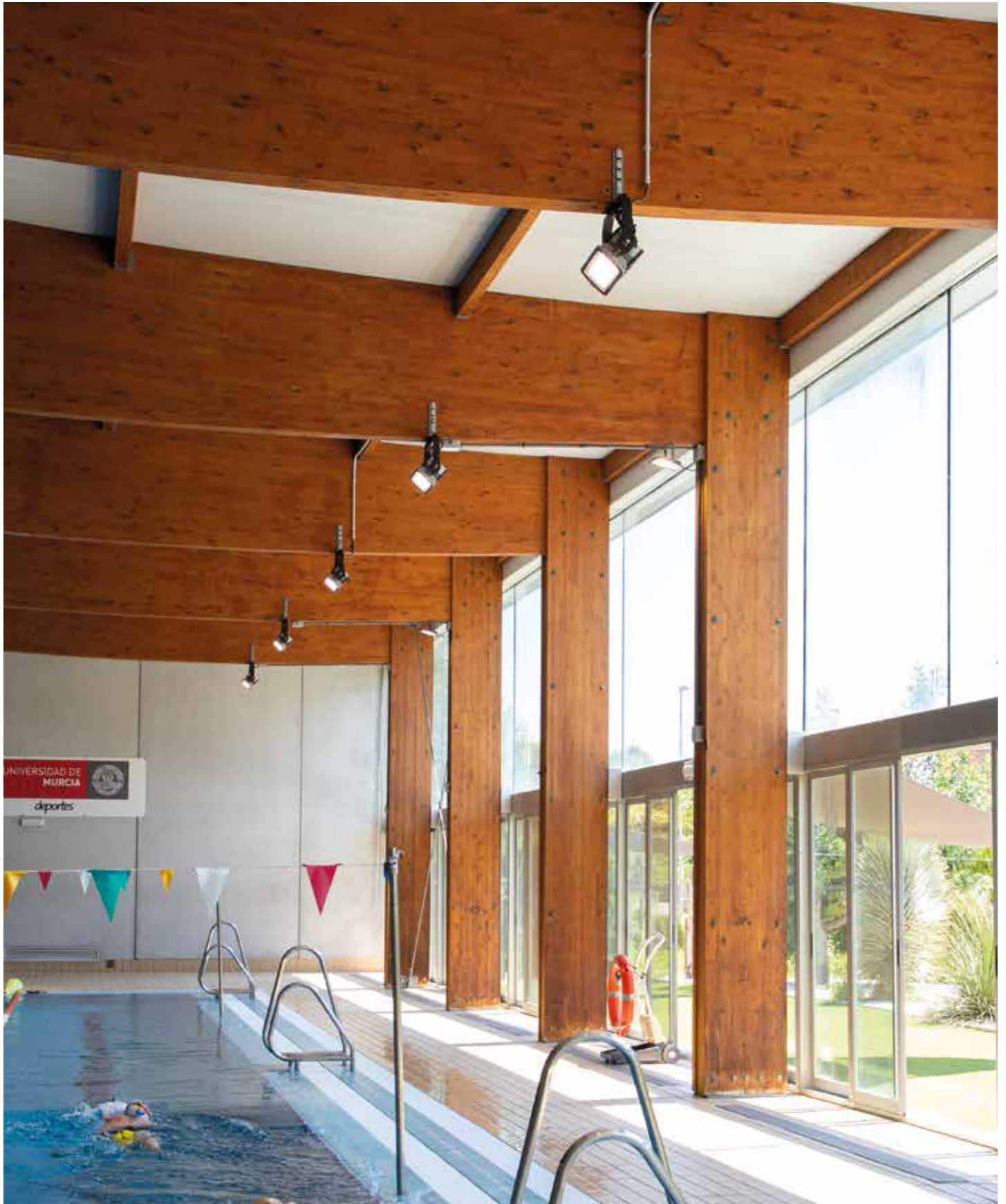





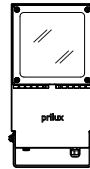

Nantes XL Play











# Spaces





# Lynx Led

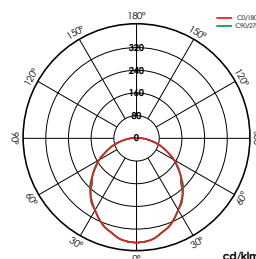
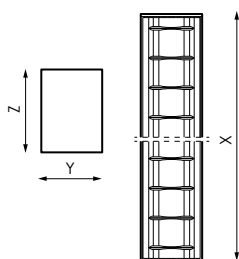
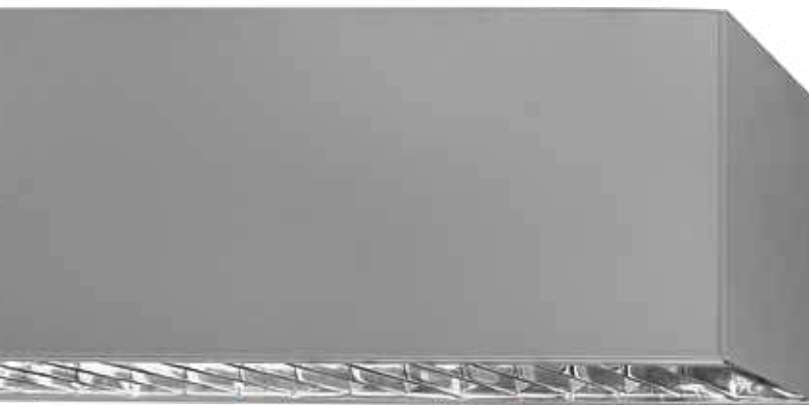

PC Opal

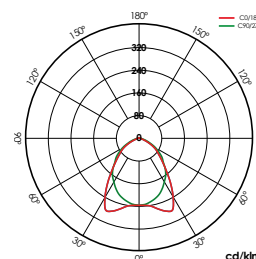

AL Especular

## ACCESORIOS / ACCESSOIRES / ACCESSORIES / ACESSÓRIOS

+ INFO PAG. 276

538237	INC. 2ud	538244	INC. 2ud	207638	INC. 1ud	537933	INC. 1ud
Kit superficie. Surface kit. Kit surface. Kit superfície.		Kit suspensión. Suspended kit. Kit suspendu. Kit suspenso.		Alimentación 3x0,75mm <sup>2</sup> . Power cable 3x0,75mm <sup>2</sup> . Cordon d'alimentation 3x0,75mm <sup>2</sup> . Cabo de alimentação 3x0,75mm <sup>2</sup> .		Alimentación 5x0,75mm <sup>2</sup> . Power cable 5x0,75mm <sup>2</sup> . Cordon d'alimentation 5x0,75mm <sup>2</sup> . Cabo de alimentação 5x0,75mm <sup>2</sup> .	

## MONTAJE / MOUNTING / MONTAGE / MONTAGEM

Ñ/ Unidades necesarias para el montaje de la luminaria.

E/ Units needed for the assembly of the luminaire.

F/ Unités nécessaires pour l'assemblage du luminaire.

P/ Unidades necessárias para a montagem da luminária.

	⌋	⌈	⌋
Cod/	Suspensión Suspension	Superficie Surface	Alimentación Power
538237	-	1ud	-
538244	1ud	-	-
207638	-	-	1ud (Dali, 1-10V, Emergencia)
537933	-	-	1ud (Salida Fija)

[GRÁFICOS: Unidades en mm/GRÁFICOS: Units in mm/GRAPHIQUES: Unités en mm/GRÁFICOS: Unidades em mm]

⚡ 220-240V

Hz 50-60Hz

🔌 390mA

Φ 0,93

K 4.000K

🌞 >80

🔄 RAL 9006

📄 AL



MADE IN SPAIN  
Desing by PRILUX



Soluciones  
Solutions  
Des solutions  
Soluções

Was Indoor  
Pág. 78

Pack Bluetooth  
Pág. 90

Pack Aulas  
Pág. 86

Pack CTE  
Pág. 82



Necesita driver DALI  
You need DALI driver  
Vous avez besoin d'un driver DALI  
Você precisa da driver DALI

	W <sub>LED</sub>	W <sub>T</sub>	φ <sub>LED</sub>	φ <sub>T</sub>			
538114	30W	32W	3.945lm	2.286lm	Al especlar	72	1.136 x 60 x 80mm
538121	30W	32W	3.945lm	2.400lm	PC Opal	72	1.136 x 60 x 80mm
538138	37W	40W	4.930lm	2.857lm	Al especlar	90	1.414 x 60 x 80mm
538145	37W	40W	4.930lm	3.000lm	PC Opal	90	1.414 x 60 x 80mm

BAJO PEDIDO / ON REQUEST / SUR COMMANDE / A PEDIDO

K



DALI



3.000K

5.000K

6.500K

WAS\*



Disponibile colores RAL  
(Consultar)  
Available RAL colors  
(Consult)  
Couleurs RAL disponibles  
(Consultar)  
Cores RAL disponíveis  
(Consultar)



Sensor de presençia y  
luminosidad.  
Presence and brightness  
sensor.  
Capteur de présence et de  
luminosité.  
Sensor de presença e  
brilho.

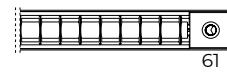

\*No compatible para luminarias 37W / \*Not compatible for 37W luminaires / \*Non compatible avec les luminaires 37W / \*Não compatível para luminárias de 37W

# Lynx Led Line

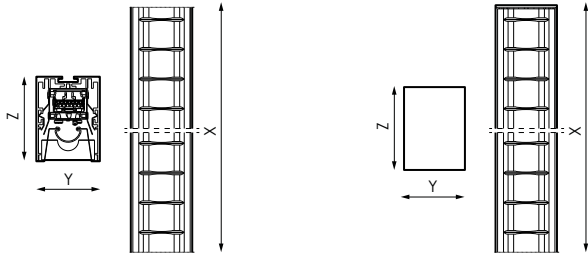

Intermedio

Inicio/Fin

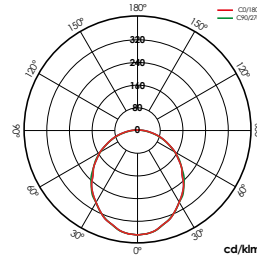

PC Opal

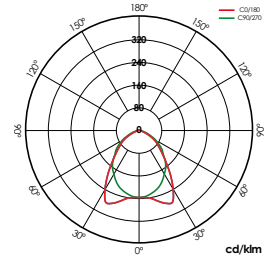

AL Especular

## ACCESORIOS / ACCESSOIRES / ACCESSORIES / ACESSÓRIOS

+ INFO PAG. 276

538237 INC. 2ud

Kit superficie.  
Surface kit.  
Kit surface.  
Kit superfície.

538244 INC. 2ud

Kit suspensión.  
Suspended kit.  
Kit suspendu.  
Kit suspenso.

207638 INC. 1ud

Alimentación 3x0,75mm<sup>2</sup>.  
Power cable 3x0,75mm<sup>2</sup>.  
Cordon d'alimentation 3x0,75mm<sup>2</sup>.  
Cabo de alimentação 3x0,75mm<sup>2</sup>.

537933 INC. 1ud

Alimentación 5x0,75mm<sup>2</sup>.  
Power cable 5x0,75mm<sup>2</sup>.  
Cordon d'alimentation 5x0,75mm<sup>2</sup>.  
Cabo de alimentação 5x0,75mm<sup>2</sup>.

## MONTAJE / MOUNTING / MONTAGE / MONTAGEM

Ñ/ N° máximo de luminarias permitidas para un punto de alimentación.

E/ Maximum number of luminaires allowed for a feed point.

F/ Le nombre maximum de permis luminaires pour un point d'alimentation.

P/ O número máximo de luminárias permitido para um ponto de alimentação.

Ñ/ Unidades necesarias para el montaje de la luminaria.

E/ Units needed for the assembly of the luminaire.

F/ Unités nécessaires pour l'assemblage du luminaire.

P/ Unidades necessárias para a montagem da luminária.

P	Ini	Inter	Fin	m/máx
1x30W	1ud	47ud	1ud	55m
1x37W	1ud	39ud	1ud	58m

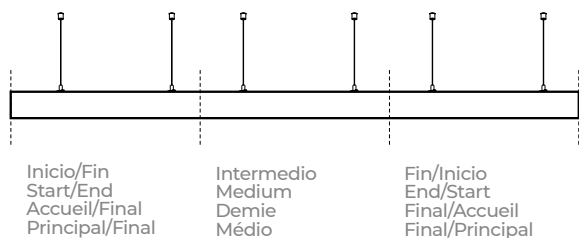

Cod/	Suspensión Suspension	Superficie Surface	Alimentación Power
538237	-	1ud	-
538244	1ud	-	-
207638	-	-	1ud (Dali, 1-10V, Emergencia)
537933	-	-	1ud (Salida Fija)

⚡ 220-240V

Hz 50-60Hz

🔌 390mA

Φ 0,93

K 4.000K

🌿 >80

🔄 RAL 9006

📦 AL



MADE IN SPAIN  
Desing by PRILUX



		$W_{LED}$	$W_T$	$\phi_{LED}$	$\phi_T$			
538152	Inicio/Fin	30W	32W	3.945lm	2.286lm	Al especular	72	1.133 x 60 x 80mm
538169	Inicio/Fin	30W	32W	3.945lm	2.400lm	PC Opal	72	1.133 x 60 x 80mm
538176	Inicio/Fin	37W	40W	4.930lm	2.857lm	Al especular	90	1.411 x 60 x 80mm
538183	Inicio/Fin	37W	40W	4.930lm	3.000lm	PC Opal	90	1.411 x 60 x 80mm
538190	Intermedio	30W	32W	3.945lm	2.286lm	Al especular	72	1.130 x 60 x 80mm
538206	Intermedio	30W	32W	3.945lm	2.400lm	PC Opal	72	1.130 x 60 x 80mm
538213	Intermedio	37W	40W	4.930lm	2.857lm	Al especular	90	1.408 x 60 x 80mm
538220	Intermedio	37W	40W	4.930lm	3.000lm	PC Opal	90	1.408 x 60 x 80mm

Soluciones  
Solutions  
Des solutions  
Soluções

Was Indoor  
Pág. 78

Pack Bluetooth  
Pág. 90

Pack Aulas  
Pág. 86

Pack CTE  
Pág. 82



Necesita driver DALI  
You need DALI driver  
Vous avez besoin d'un driver DALI  
Você precisa da driver DALI

BAJO PEDIDO / ON REQUEST / SUR COMMANDE / A PEDIDO

K

3.000K

5.000K

6.500K

WAS\*



DALI

Bluetooth



Disponibile colores RAL  
(Consultar)  
Available RAL colors  
(Consult)  
Couleurs RAL disponibles  
(Consultar)  
Cores RAL disponíveis  
(Consultar)



Sensor de presencia y  
luminosidad.  
(5 luminarias máx.)  
Presence and brightness  
sensor.  
(5 luminaires max.)  
Capteur de présence et de  
luminosité.  
(5 luminaires max.)  
Sensor de presença e  
brilho.  
(5 luminárias máx.)

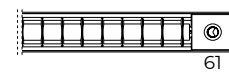

\*No compatible para luminarias 37W / \*Not compatible for 37W luminaires / \*Non compatible avec les luminaires 37W / \*Não compatível para luminárias de 37W



# Lynx Led

## Empotrar

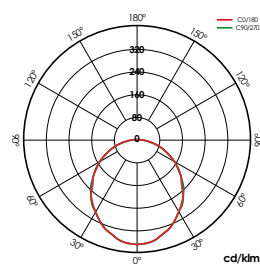
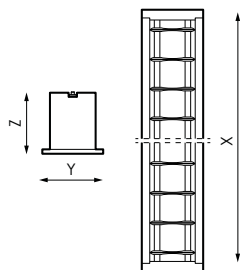
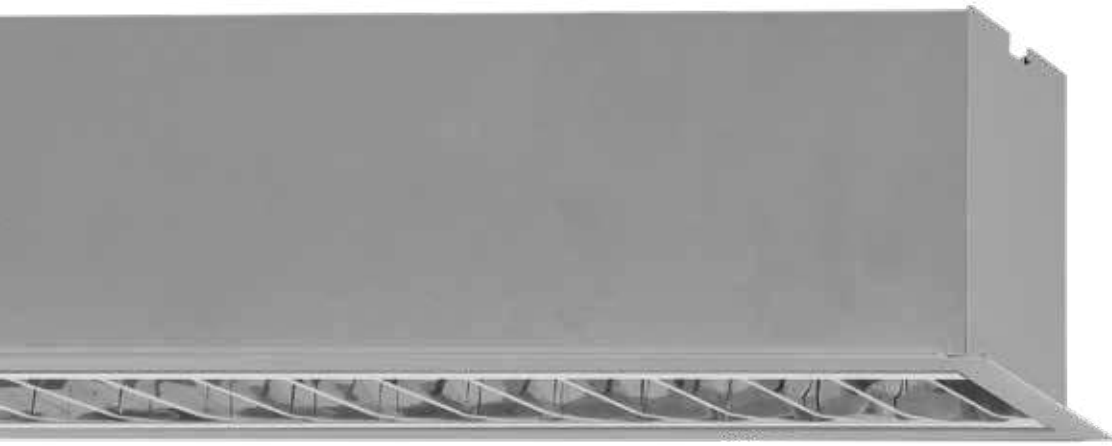

PC Opal

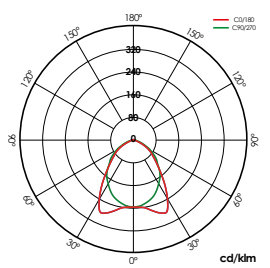

AL Especular

⚡ 220-240V

Hz 50-60Hz

⏏ 390mA

Φ 0,93

K 4.000K

☼ >80

⊗ RAL 9006

Ⓜ AL



MADE IN SPAIN  
Desing by PRILUX



Soluciones  
Solutions  
Des solutions  
Soluções

Was Indoor  
Pág. 78

Pack Bluetooth  
Pág. 90

Pack Aulas  
Pág. 86

Pack CTE  
Pág. 82



Necesita driver DALI  
You need DALI driver  
Vous avez besoin d'un driver DALI  
Você precisa da driver DALI

	$W_{LED}$	$W_T$	$\phi_{LED}$	$\phi_T$				
490399	30W	32W	3,945lm	2,286lm	Al especcular	72	1,142x68mm	1,154 x 80 x 80mm
490405	30W	32W	3,945lm	2,400lm	PC Opal	72	1,142x68mm	1,154 x 80 x 80mm
490412	37W	40W	4,930lm	2,857lm	Al especcular	90	1,420x68mm	1,432 x 80 x 80mm
490429	37W	40W	4,930lm	3,000lm	PC Opal	90	1,420x68mm	1,432 x 80 x 80mm

BAJO PEDIDO / ON REQUEST / SUR COMMANDE / A PEDIDO

K



DALI



3,000K

5,000K

6,500K

WAS\*



Disponibile colores RAL  
(Consultar)  
Available RAL colors  
(Consult)  
Couleurs RAL disponibles  
(Consultar)  
Cores RAL disponíveis  
(Consultar)



Sensor de presencia y  
luminosidad.  
Presence and brightness  
sensor.  
Capteur de présence et de  
luminosité.  
Sensor de presença e  
brilho.

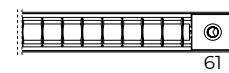

\*No compatible para luminarias 37W / \*Not compatible for 37W luminaires / \*Non compatible avec les luminaires 37W / \*Não compatível para luminárias de 37W

# Lynx Led

## Line Empotrar

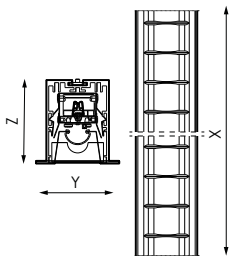
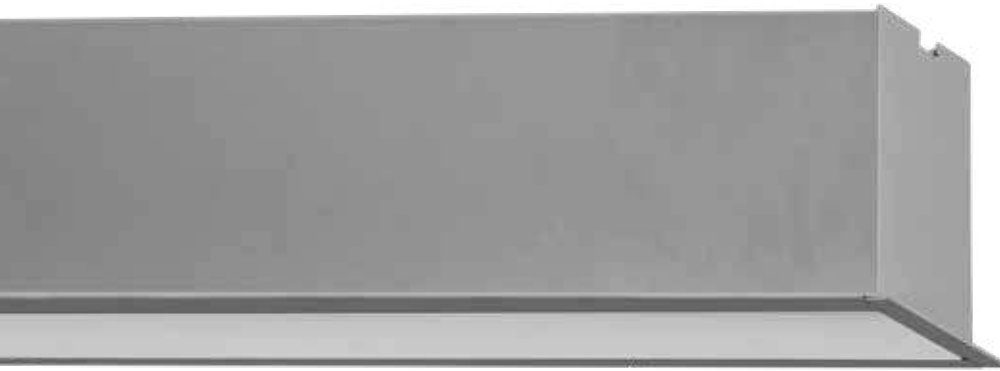

Intermedio

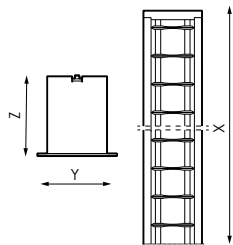

Inicio/Fin

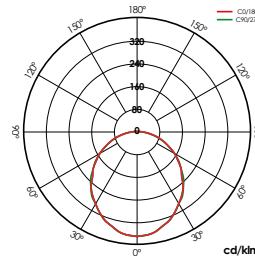

PC Opal

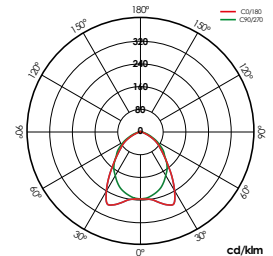

AL Especular

### MONTAJE / MOUNTING / MONTAGE / MONTAGEM

**Ñ**/ N° máximo de luminarias permitidas para un punto de alimentación.

**E**/ Maximum number of luminaires allowed for a feed point.

**F**/ Le nombre maximum de permis luminaires pour un point d'alimentation.

**P**/ O número máximo de luminárias permitido para um ponto de alimentação.

P	Ini/ Fin	Inter	m/máx
1x30W	2ud	47ud	55m
1x37W	2ud	39ud	58m

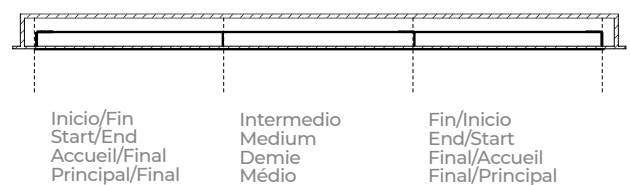

⚡ 220-240V

Hz 50-60Hz

⏏ 390mA

Φ 0,93

K 4.000K

🌿 >80

⊗ RAL 9006

📄 AL



MADE IN SPAIN  
Desing by PRILUX



Barcode	Icon	W <sub>LED</sub>	W <sub>T</sub>	Φ <sub>LED</sub>	Φ <sub>T</sub>	Material	Height	Depth	Length
490436	Inicio/Fin	30W	32W	3.945lm	2.286lm	Al especcular	72	1.136 x 68mm	1.142 x 80 x 80mm
490474	Inicio/Fin	30W	32W	3.945lm	2.400lm	PC Opal	72	1.136 x 68mm	1.142 x 80 x 80mm
490443	Inicio/Fin	37W	40W	4.930lm	2.857lm	Al especcular	90	1.414 x 68mm	1.420 x 80 x 80mm
490481	Inicio/Fin	37W	40W	4.930lm	3.000lm	PC Opal	90	1.414 x 68mm	1.420 x 80 x 80mm
490450	Intermedio	30W	32W	3.945lm	2.286lm	Al especcular	72	1.130 x 68mm	1.130 x 80 x 80mm
490498	Intermedio	30W	32W	3.945lm	2.400lm	PC Opal	72	1.130 x 68mm	1.130 x 80 x 80mm
490467	Intermedio	37W	40W	4.930lm	2.857lm	Al especcular	90	1.408 x 68mm	1.408 x 80 x 80mm
490504	Intermedio	37W	40W	4.930lm	3.000lm	PC Opal	90	1.408 x 68mm	1.408 x 80 x 80mm

Soluciones  
Solutions  
Des solutions  
Soluções

Was Indoor  
Pág. 78

Pack Bluetooth  
Pág. 90

Pack Aulas  
Pág. 86

Pack CTE  
Pág. 82



Necesita driver DALI  
You need DALI driver  
Vous avez besoin d'un driver DALI  
Você precisa da driver DALI

BAJO PEDIDO / ON REQUEST / SUR COMMANDE / A PEDIDO

K



3.000K

DALI

Disponibile colores RAL  
(Consultar)  
Available RAL colors  
(Consult)  
Couleurs RAL disponibles  
(Consultar)  
Cores RAL disponíveis  
(Consultar)

Sensor de presencia y  
luminosidad .  
(5 luminarias máx.)  
Presence and brightness  
sensor.  
(5 luminaires max.)  
Capteur de présence et de  
luminosité.  
(5 luminaires max.)  
Sensor de presença e  
brilho.  
(5 luminárias máx.)

5.000K



6.500K

WAS\*

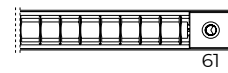

\*No compatible para luminarias 37W / \*Not compatible for 37W luminaires / \*Non compatible avec les luminaires 37W / \*Não compatível para luminárias de 37W



# Lynx Led

## Pared



Anclaje Pared  
Wall Anchorage  
Ancrage au mur  
Ancoradouro de Parede

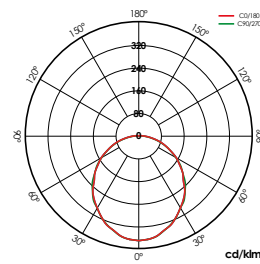
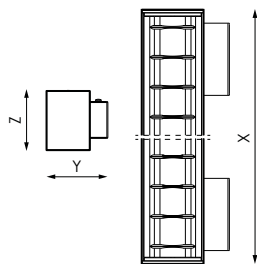

PC Opal

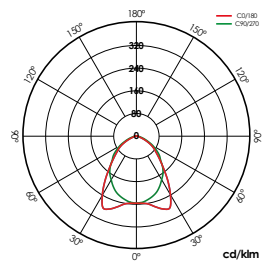

AL Especular

⚡ 220-240V

Hz 50-60Hz

📏 390mA

Φ 0,93

K 4.000K

🌿 >80

🔄 RAL 9006

📄 AL



MADE IN SPAIN  
Desing by PRILUX

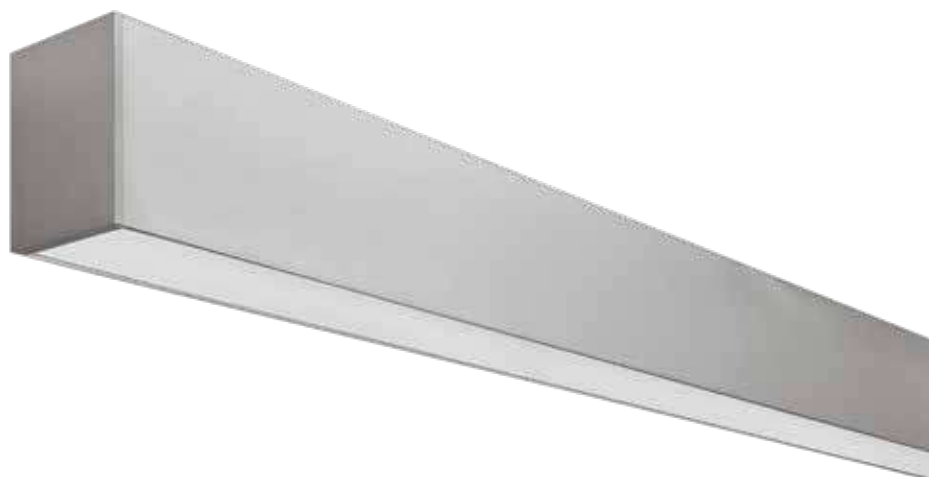

Soluciones  
Solutions  
Des solutions  
Soluções

Was Indoor  
Pág. 78

Pack Bluetooth  
Pág. 90

Pack Aulas  
Pág. 86

Pack CTE  
Pág. 82



Necesita driver DALI  
You need DALI driver  
Vous avez besoin d'un driver DALI  
Você precisa da driver DALI

	W <sub>LED</sub>	W <sub>T</sub>	Φ <sub>LED</sub>	Φ <sub>T</sub>			
482356	30W	32W	3.945lm	2.286lm	Al especlar	72	1.136x85x80mm
482363	30W	32W	3.945lm	2.400lm	PC Opal	72	1.136x85x80mm
482370	37W	40W	4.930lm	2.857lm	Al especlar	90	1.414x85x80mm
482387	37W	40W	4.930lm	3.000lm	PC Opal	90	1.414x85x80mm

BAJO PEDIDO / ON REQUEST / SUR COMMANDE / A PEDIDO

K

3.000K

5.000K

6.500K

WAS\*



DALI



Disponibile colores RAL (Consultar)  
Available RAL colors (Consult)  
Couleurs RAL disponibles (Consultar)  
Cores RAL disponíveis (Consultar)

\*No compatible para luminarias 37W/ \*Not compatible for 37W luminaires/ \*Non compatible avec les luminaires 37W/  
\*Não compatível para luminárias de 37W



Stania

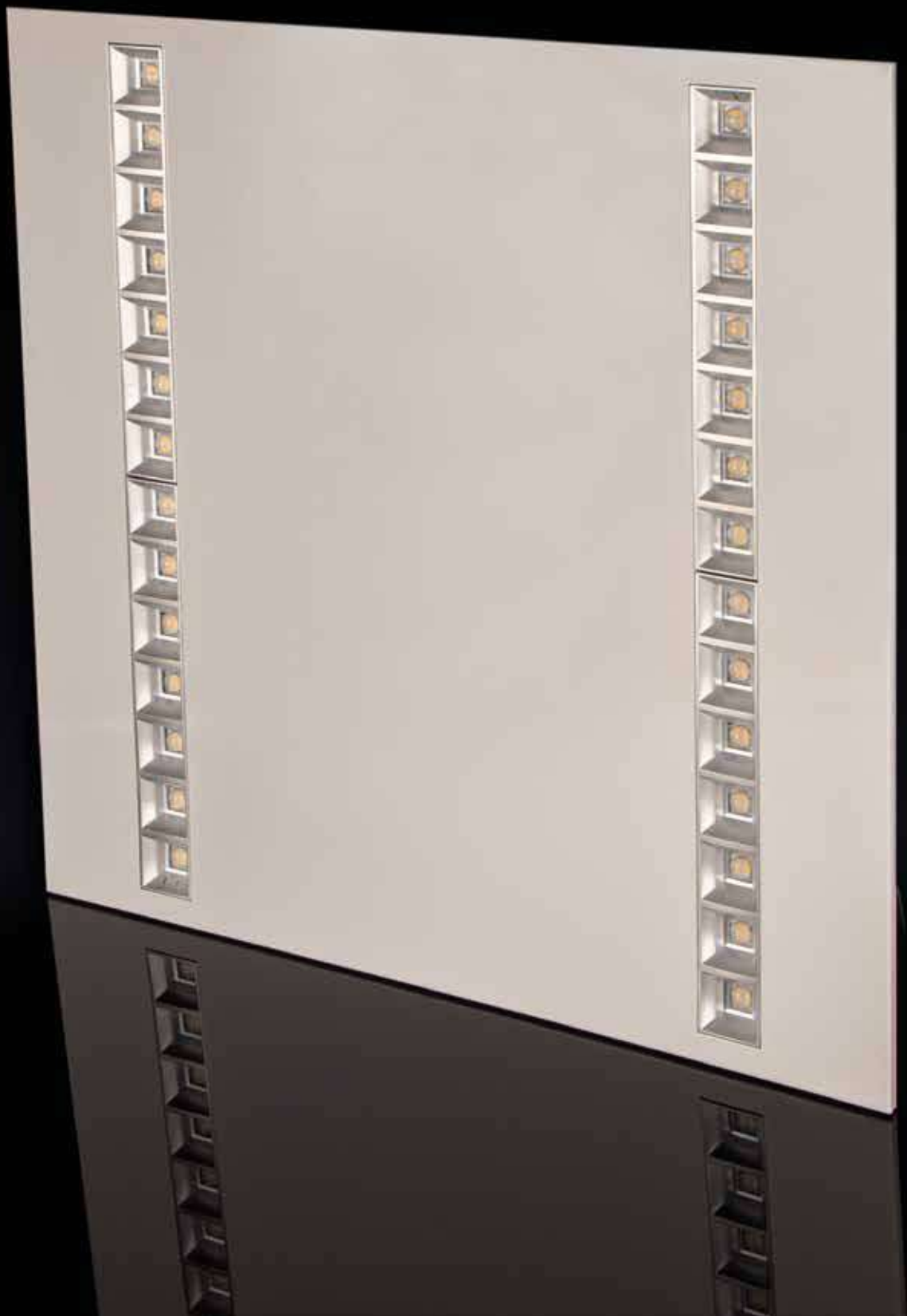



# Stania

**Ñ/** Con un diseño claro, discreto y de aplicación universal, sumado a la alta calidad de sus materiales y acabados, la luminaria tiene un gran potencial para instalaciones interiores gracias a sus opciones de reflectores, entregando una calidad lumínica elevada, con un nivel de deslumbramiento controlado y una óptima eficiencia energética.

**E/** With a clear, discreet and universally applicable design, added to the high quality of its materials and finishes, the luminaire has great potential for indoor installations thanks to its reflector options, providing high light quality, with a controlled glare level. and optimal energy efficiency.

**F/** Avec un design clair, discret et universellement applicable, couplé à la haute qualité de ses matériaux et de ses finitions, le luminaire a un grand potentiel pour les installations intérieures grâce à ses options de réflecteur, offrant une haute qualité de lumière, avec un niveau d'éblouissement contrôlé et une efficacité énergétique optimale.

**P/** Com um design claro, discreto e universalmente aplicável, aliado à alta qualidade dos seus materiais e acabamentos, a luminária tem um grande potencial para instalações interiores graças às suas opções de refletores, proporcionando alta qualidade de luz, com nível de brilho controlado e ótima eficiência energética.

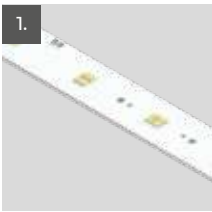
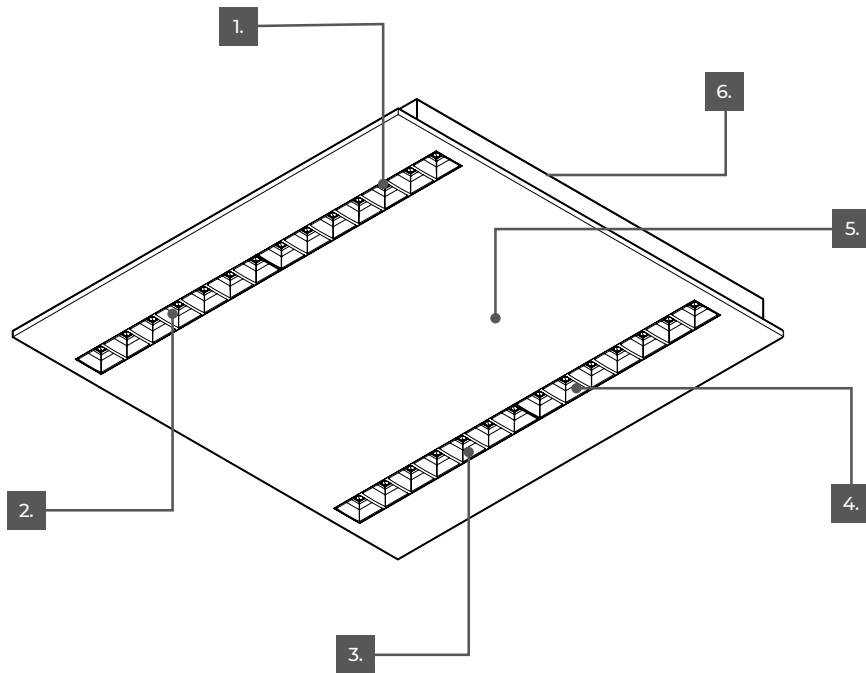

Ñ/ Módulo de Led

E/ Led module

F/ Module mené

P/ Módulo Led



Ñ/ Lente  
PMMA de alta transparencia

E/ Lens  
High transparency PMMA

F/ Lentille  
PMMA haute transparence

P/ Lente  
PMMA de alta transparência



Ñ/ Reflector  
PC metalizado por alto vacío

E/ Reflector  
High vacuum metallized PC

F/ Réflecteur  
PC métallisé sous vide poussé

P/ Refletor  
PC metalizado de alto vácuo

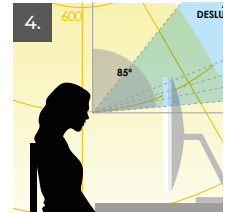

Ñ/ UGR <19

E/ UGR <19

F/ UGR <19

P/ UGR <19

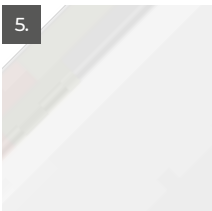

Ñ/ Cuerpo

Acero termoestallado con  
pintura en polvo en RAL 9016

E/ Body

Powder-coated enameled steel  
in RAL 9016

F/ Corps

Acier émaille peint par poudrage  
en RAL 9016

P/ Corpo

Aço esmaltado revestido a pó  
em RAL 9016



Ñ/ Conexión eléctrica

Clema de conexión rápida de 3  
o 5 polos

E/ Electric connection

3 or 5 pole quick connection  
terminal

F/ Connexion électrique

Borne de connexion rapide 3 ou  
5 pôles

P/ Conexão elétrica

Terminal de conexão rápida de 3  
ou 5 polos

# Stania

<b>N</b> NEW	CI	L / IP20 CV / IP40	IK04	L80B10 > 150.000h L90B10 > 74.000h	-30~+35°C
-----------------	----	-----------------------	------	---------------------------------------	-----------

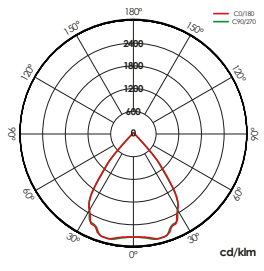
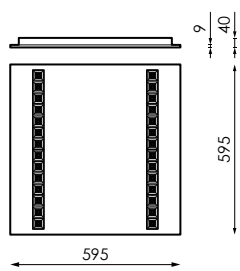
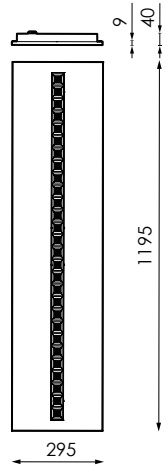
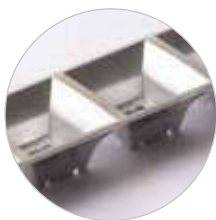

AL-BR

[GRÁFICOS: Unidades en mm/ GRAPHICS: Units in mm/GRÁFICOS: Unidades en mm/GRÁFICOS: Unidades en mm]

⚡ 220-240V

Hz 50-60Hz

🔌 300mA

Φ 0,97

K 4.000K

📺 UGR <19

🌿 >80

💡 112

🌀 RAL 9016

🏠 PMMA de alta transparencia

🔪 PC metalizado por alto vacío

📦 Acero termoestablado con pintura en polvo

📖 5,7kg

⬆️ Empotrar



MADE IN SPAIN  
Desing by PRILUX



Soluciones  
Solutions  
Des solutions  
Soluções

Was Indoor  
Pág. 78

Pack Bluetooth  
Pág. 90

Pack Aulas  
Pág. 86

Pack CTE  
Pág. 82



Necesita driver DALI  
You need DALI driver  
Vous avez besoin d'un driver DALI  
Você precisa da driver DALI

	$W_{LED}$	$W_T$	$\phi_{LED}$	$\phi_T$	$\phi/W$			
526340	24W	26W	4.345lm	3.879lm	149lm/W	AL-BR	595 x 595 x 40mm	NO
562713	24W	26W	4.345lm	3.819lm	147lm/W	BL-MT	595 x 595 x 40mm	NO
530118	24W	26W	4.345lm	3.879lm	149lm/W	AL-BR	595 x 595 x 40mm	DALI
562720	24W	26W	4.345lm	3.819lm	147lm/W	BL-MT	595 x 595 x 40mm	DALI
575720	24W	26W	4.345lm	3.879lm	149lm/W	AL-BR	295 x 1.195x 40mm	NO
575744	24W	26W	4.345lm	3.819lm	147lm/W	BL-MT	295 x 1.195x 40mm	NO
575737	24W	26W	4.345lm	3.879lm	149lm/W	AL-BR	295 x 1.195x 40mm	DALI
575751	24W	26W	4.345lm	3.819lm	147lm/W	BL-MT	295 x 1.195x 40mm	DALI

BAJO PEDIDO / ON REQUEST / SUR COMMANDE / A PEDIDO

	K			
>80	3.000K			AL-MT (Aluminio mate)
	3.000K			DO-MT (Dorado mate)
>90	4.000K			CO-MT (Cobre mate)
Otros (consultar)				NE-MT (Negro mate)

Disponible colores RAL  
(Consultar)  
Available RAL colors  
(Consult)  
Couleurs RAL disponibles  
(Consultar) Cores RAL  
disponíveis (Consultar)



# Silent Led V

## IP65

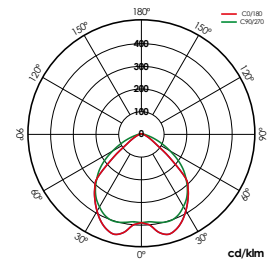
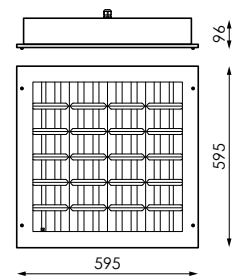

V IP65

### ACCESORIOS / ACCESSOIRES / ACCESSORIES / ACESSÓRIOS

+ INFO PAG. 276

150187

Accesorio para techos de escayola de 0,5-20mm de espesor para modelos de 600x600mm (Contiene 4ud.)

0.5-20mm thick plaster ceiling accessory for 600x600mm models (Contains 4ud.)

Accessoires plafonds 0,5-20mm d'épaisseur de plâtre pour les modèles 600x600mm (Contient 4ud.)

Tetos de gesso acessórios 0,5-20mm de espessura para os modelos 600x600mm (contém 4ud.)











### INFORMACIÓN / INFORMATION / INFORMATION / INFORMAÇÕES

Ñ/ Acabado polimérico resistente al peróxido de hidrógeno.

E/ Hydrogen peroxide resistant polymeric finish.

F/ Fini polymère résistant au peroxyde d'hydrogène.

P/ Acabamento polimérico resistente ao peróxido de hidrogênio.

 220-240V
<b>Hz</b> 50-60Hz
<b>K</b> 4.000K
 >80
 144
 BL
 FE
 AL
 PC-T
 PC-T
 EMPOTRAR



Soluciones  
Solutions  
Des solutions  
Soluções

Pack   
Pág. 90

Pack Aulas  
Pág. 86

Pack CTE  
Pág. 82



Necesita driver DALI  
You need DALI driver  
Vous avez besoin d'un driver DALI  
Você precisa da driver DALI

	$W_{LED}$	$W_T$		$\phi_{LED}$	$\phi_T$
400268	4x13W	54W	350mA	6.840lm	4.663lm

BAJO PEDIDO / ON REQUEST / SUR COMMANDE / A PEDIDO

<b>K</b>		
3.000K	DALI	Kit de emergencia Emergency kit Trousse d'urgence Kit de emergência
5.000K		
6.500K		

# Kobe

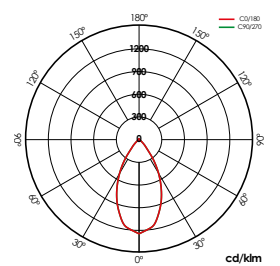
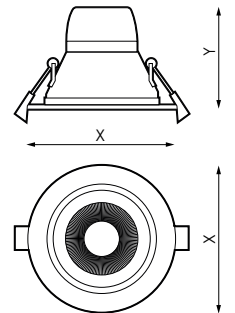
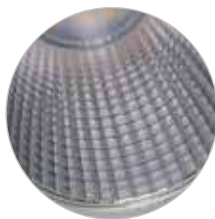

12W

⚡ 220-240V

Hz 50-60Hz

📺 UGR <19

🌿 >80

∞ BL

📺 AL

📺 ALAN

↑ Empotrar



Soluciones  
Solutions  
Des solutions  
Soluções

Pack Bluetooth  
Pág. 90

Pack Aulas  
Pág. 86

Pack CTE  
Pág. 82



Necesita driver DALI  
You need DALI driver  
Vous avez besoin d'un driver DALI  
Você precisa da driver DALI

	$W_{LED}$	$W_T$		$\phi_{LED}$	$\phi_T$	$A$	$K$	$\leftrightarrow$ (x1-z)	
469234*	12W	15W	700mA	1.427lm	1.182lm	50°	3.000K	Ø145 x 79,5mm	Ø120 -130mm
442077*	12W	15W	700mA	1.561lm	1.249lm	50°	4.000K	Ø145 x 79,5mm	Ø120 -130mm
469265*	25W	28W	700mA	2.935lm	2.363lm	60°	3.000K	Ø232 x 118mm	Ø195 - 210mm
469258*	31W	35W	900mA	3.780lm	2.871lm	60°	3.000K	Ø232 x 118mm	Ø195 - 210mm

BAJO PEDIDO / ON REQUEST / SUR COMMANDE / A PEDIDO



DALI

Bluetooth



Kit de emergencia  
Emergency kit  
Trousse d'urgence  
Kit de emergência

\*Hasta fin de existencias\* • Until end of stock\* • Jusqu'à épuisement des stocks\* • Enquanto os estoques durarem



# Kobe

## Switch



Con selector de tº de color a través de interruptor  
With tº color selector through switch  
Avec sélecteur tº de couleur par commutateur  
Com o seletor de cores através da chave

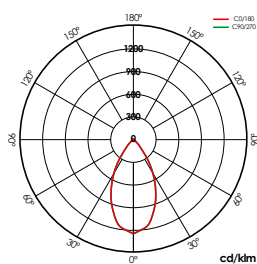
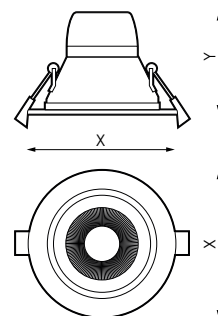

12W

⚡ 220-240V

Hz 50-60Hz

📺 UGR <19

🌿 >80

∞ BL

📄 AL

📄 ALAN

⤴ Empotrar



📊	W <sub>LED</sub>	W <sub>T</sub>	🔌	ϕ <sub>LED</sub>	ϕ <sub>T</sub>	△	K	↔ (x-y-z)	📏	
492652	12W	15W	700mA	1.427lm 1.561lm	1.182lm 1.249lm	50°	3.000K 4.000K	Ø145 x 81,8mm	Ø120 -130mm	NO
<b>N</b> 585415	12W	15W	700mA	1.427lm 1.561lm	1.182lm 1.249lm	50°	3.000K 4.000K	Ø145 x 81,8mm	Ø120 -130mm	DALI
492669	18W	20W	700mA	2.156lm 2.244lm	1.697lm 1.818lm	50°	3.000K 4.000K	Ø174 x 88,8mm	Ø145-155mm	NO
<b>N</b> 585316	18W	20W	700mA	2.156lm 2.244lm	1.697lm 1.818lm	50°	3.000K 4.000K	Ø174 x 88,8mm	Ø145-155mm	DALI
492676	25W	28W	700mA	2.935lm 3.106lm	2.363lm 2.517lm	60°	3.000K 4.000K	Ø232 x 112,8mm	Ø195 - 210mm	NO
<b>N</b> 515979	25W	28W	700mA	2.935lm 3.106lm	2.363lm 2.517lm	60°	3.000K 4.000K	Ø232 x 112,8mm	Ø195 - 210mm	DALI
492683	31W	35W	900mA	3.780lm 4.032lm	2.871lm 3.185lm	60°	3.000K 4.000K	Ø232 x 112,8mm	Ø195 - 210mm	NO
<b>N</b> 508650	31W	35W	900mA	3.780lm 4.032lm	2.871lm 3.185lm	60°	3.000K 4.000K	Ø232 x 112,8mm	Ø195 - 210mm	DALI

BAJO PEDIDO / ON REQUEST / SUR COMMANDE / A PEDIDO



Bluetooth



Kit de emergencia  
Emergency kit  
Trousse d'urgence  
Kit de emergência

Soluciones  
Solutions  
Des solutions  
Soluções

Pack Bluetooth<sup>®</sup>  
Pág. 90





Pack Aulas  
Pág. 86

Pack CTE  
Pág. 82



Necesita driver DALI  
You need DALI driver  
Vous avez besoin d'un driver DALI  
Você precisa da driver DALI

# Tribola

		C / IP65 (18W)	
CI		C / IP54 (25 - 35W)	L70 > 30.000h

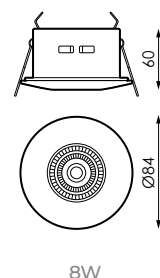

8W

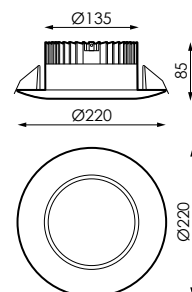

25W/35W

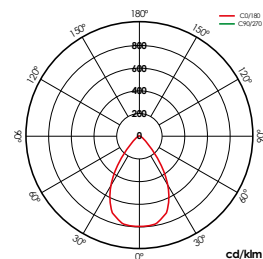

35W

## INFORMACIÓN / INFORMATION / INFORMATION / INFORMAÇÕES

**Ñ** / \*UGR <19 con R(%):70/70/30,  
S(m2)<36 y h(m)≥2,8.

**E** / \*UGR <19 with R(%):70/70/30,  
S(m2)<36 y h(m)≥2,8.

**F** / \*UGR <19 avec  
R(%):70/70/30, S(m2)<36 y  
h(m)≥2,8.

**P** / \*UGR <19 com  
R(%):70/70/30, S(m2)<36 y  
h(m)≥2,8.

⚡ 220-240V

Hz 50-60Hz

Φ 0,90

🌿 >80

📦 AL

☒ ALAN

⚡ V

↑ Empotrar



8W



25W/35W



8W



25W / 35W

📊	W <sub>LED</sub>	W <sub>T</sub>	📏	φ <sub>LED</sub>	φ <sub>T</sub>	∠	K	⊗	📏
234054	8W	9W	670mA	834lm	667lm	45°	3.000K	BL	Ø75mm
234061	8W	9W	670mA	879lm	703lm	45°	4.000K	BL	Ø75mm
234078	8W	9W	670mA	834lm	667lm	45°	3.000K	NI	Ø75mm
234085	8W	9W	670mA	879lm	703lm	45°	4.000K	NI	Ø75mm
233293*	25W	29W	670mA	2.866lm	2.295lm	60°	3.000K	BL	Ø160mm
233309*	25W	29W	670mA	3.049lm	2.442lm	60°	4.000K	BL	Ø160mm
233279*	35W	42W	1.030mA	3.638lm	2.913lm	60°	3.000K	BL	Ø160mm
233286*	35W	42W	1.030mA	3.871lm	3.099lm	60°	4.000K	BL	Ø160mm

BAJO PEDIDO / ON REQUEST / SUR COMMANDE / A PEDIDO



DALI



Kit de emergencia  
Emergency kit  
Trousse d'urgence  
Kit de emergência

\*Hasta fin de existencias\* • Until end of stock\* • Jusqu'à épuisement des stocks\* • Enquanto os estoques durarem

Soluciones  
Solutions  
Des solutions  
Soluções

Pack Bluetooth  
Pág. 90

Pack Aulas  
Pág. 86

Pack CTE  
Pág. 82



Necesita driver DALI  
You need DALI driver  
Vous avez besoin d'un driver DALI  
Você precisa da driver DALI



# Ebro Led

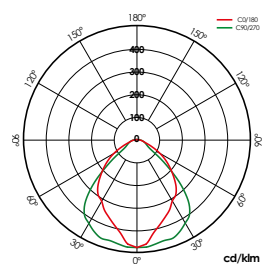
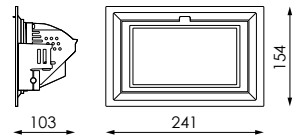

⚡ 220-240V

Hz 50-60Hz

Φ 0,96

🌿 >80

↻ 50°

☑ AL

☒ ALAN

☑ VT

↑ Empotrar



Soluciones  
Solutions  
Des solutions  
Soluções

Pack Bluetooth  
Pág. 90

Pack Aulas  
Pág. 86

Pack CTE  
Pág. 82



Necesita driver DALI  
You need DALI driver  
Vous avez besoin d'un driver DALI  
Você precisa da driver DALI

	$W_{LED}$	$W_T$		$\phi_{LED}$	$\phi_T$	$\Delta$	$K$		
144544*	25,8W	30W	800mA	2.705lm	2.164lm	67°	3.000K	BL	220 x 132mm
140706*	25,8W	30W	800mA	2.784lm	2.278lm	67°	4.000K	BL	220 x 132mm
390965*	25,8W	30W	800mA	2.705lm	2.164lm	67°	3.000K	N	220 x 132mm
390958*	25,8W	30W	800mA	2.784lm	2.278lm	67°	4.000K	N	220 x 132mm
381611*	55W	58W	1.200mA	4.679lm	3.743lm	80°	3.000K	BL	220 x 132mm
381628*	55W	58W	1.200mA	4.894lm	3.940lm	80°	4.000K	BL	220 x 132mm

BAJO PEDIDO / ON REQUEST / SUR COMMANDE / A PEDIDO



DALI



Kit de emergencia  
Emergency kit  
Trousse d'urgence  
Kit de emergência

\*Hasta fin de existencias\* • Until end of stock\* • Jusqu'à épuisement des stocks\* • Enquanto os estoques durarem

# Miño Led

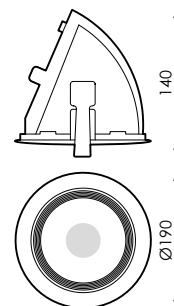

35W

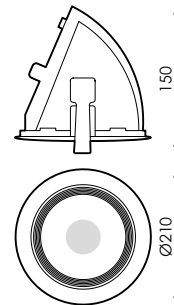

50W

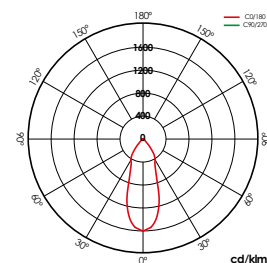
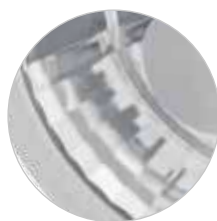

50W

## INFORMACIÓN / INFORMATION / INFORMATION / INFORMAÇÕES

**Ñ**/ Vidrio transparente con sección central mate para un adecuado control del deslumbramiento.

**E**/ Transparent glass with matte central section for an adequate glare control

**F**/ Verre transparent avec section centrale mat pour un contrôle de l'éblouissement adéquate.

**P**/ Vidro transparente com seção central matte para um controle de brilho adequada.

⚡ 220-240V

Hz 50-60Hz

Φ 0,96



∞ BL

↻ 50°

↕ +135° / -135°

AL

☒ ALAN

V

↑ Empotrar



Soluciones  
Solutions  
Des solutions  
Soluções

Pack Bluetooth  
Pág. 90

Pack Aulas  
Pág. 86

Pack CTE  
Pág. 82



Necesita driver DALI  
You need DALI driver  
Vous avez besoin d'un driver DALI  
Você precisa da driver DALI

	W <sub>LED</sub>	W <sub>T</sub>		Φ <sub>LED</sub>	Φ <sub>T</sub>	Δ	K	
144551*	35W	38W	1.050mA	3.909lm	3.557lm	40°	3.000K	Ø170mm
144049*	35W	38W	1.050mA	4.046lm	3.667lm	40°	4.000K	Ø170mm
210027*	35W	38W	1.050mA	3.909lm	3.236lm	100°	3.000K	Ø170mm
237963*	35W	38W	1.050mA	4.046lm	3.359lm	100°	4.000K	Ø170mm
381635*	50W	52W	1.150mA	5.812lm	4.626lm	40°	3.000K	Ø190mm
381642*	50W	52W	1.150mA	5.951lm	4.845lm	40°	4.000K	Ø190mm

BAJO PEDIDO / ON REQUEST / SUR COMMANDE / A PEDIDO



DALI



Kit de emergencia  
Emergency kit  
Trousse d'urgence  
Kit de emergência

\*Hasta fin de existencias • Until end of stock • Jusqu'à épuisement des stocks • Enquanto os estoques durarem



# Voltore

## Modelo I

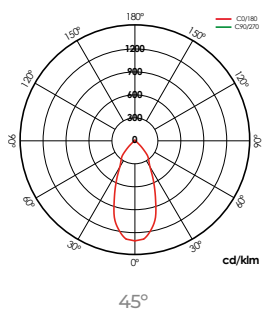
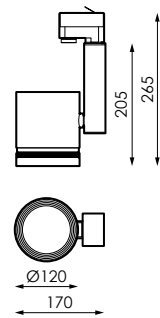

### INFORMACIÓN / INFORMATION / INFORMATION / INFORMAÇÕES

**Ñ/** Carril electrificado trifásico y accesorios en blanco, negro y gris.

Adaptador para carril trifásico 250V 6A.

**E/** Three-phase electrified rail and accessories in white, black and grey.

Adapter for three phase track 250V 6A.

**F/** Rail électrique triphasé et accessoires en blanc, noir et gris.

Adaptateur pour le montage à trois phases voies 250V 6A.

**P/** Trilha eletrificada trifásica e acessórios em branco, preto e cinza.

Adaptador para calha trifásica 250V 6A.

### ACCESORIOS / ACCESSOIRES / ACCESSORIES / ACESSÓRIOS

+ INFO PAG. 276

⚡ 220-240V

Hz 50-60Hz

🌿 >80

↻ +90° / -90°

⤴ +135° / -135°

📄 AL

☒ ALAN

📄 VT

↑ Carril



MADE IN SPAIN  
Desing by PRILUX



	W <sub>LED</sub>	W <sub>T</sub>		Φ <sub>LED</sub>	Φ <sub>T</sub>	K		
535557*	13W	16W	380mA	2.075lm	1.939lm	3.000K	N	DALI
535571*	13W	16W	380mA	2.184lm	2.041lm	4.000K	N	DALI
535595*	28W	32W	750mA	3.450lm	3.225lm	3.000K	N	DALI
535618*	28W	32W	750mA	3.632lm	3.394lm	4.000K	N	DALI
535540*	13W	16W	380mA	2.075lm	1.939lm	3.000K	BL	DALI
535564*	13W	16W	380mA	2.184lm	2.041lm	4.000K	BL	DALI
535588*	28W	32W	750mA	3.450lm	3.225lm	3.000K	BL	DALI
535601*	28W	32W	750mA	3.632lm	3.394lm	4.000K	BL	DALI
205306*	13W	16W	380mA	2.075lm	1.939lm	3.000K	N	NO
205313*	13W	16W	380mA	2.184lm	2.041lm	4.000K	N	NO
205276*	28W	32W	750mA	3.450lm	3.225lm	3.000K	N	NO
205283*	28W	32W	750mA	3.632lm	3.394lm	4.000K	N	NO
205351*	13W	16W	380mA	2.075lm	1.939lm	3.000K	BL	NO
205368*	13W	16W	380mA	2.184lm	2.041lm	4.000K	BL	NO
205337*	28W	32W	750mA	3.450lm	3.225lm	3.000K	BL	NO
205344*	28W	32W	750mA	3.632lm	3.394lm	4.000K	BL	NO

BAJO PEDIDO / ON REQUEST / SUR COMMANDE / A PEDIDO

K

CHROMALIFE® Museum

CHROMALIFE® Retail

CHROMALIFE® Health

CHROMALIFE® Fish

CHROMALIFE® Meat

CHROMALIFE® Bakery



Bluetooth®

\*Hasta fin de existencias • Until end of stock • Jusqu'à épuisement des stocks • Enquanto os estoques durarem

# Voltore

## Modelo II

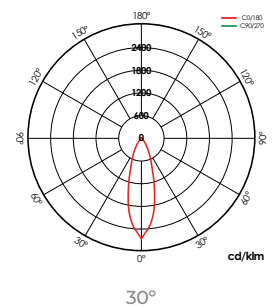
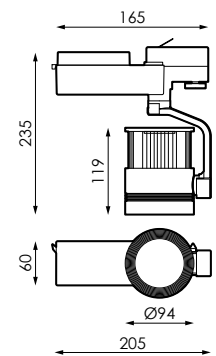

### INFORMACIÓN / INFORMATION / INFORMATION / INFORMAÇÕES

**Ñ** / Carril electrificado trifásico y accesorios en blanco, negro y gris.

Adaptador para carril trifásico 250V 6A.

**E** / Three-phase electrified rail and accessories in white, black and grey.

Adapter for three phase track 250V 6A.

**F** / Rail électrique triphasé et accessoires en blanc, noir et gris.

Adaptateur pour le montage à trois phases voies 250V 6A.

**P** / Trilha eletrificada trifásica e acessórios em branco, preto e cinza.

Adaptador para calha trifásica 250V 6A.

### ACCESORIOS / ACCESSOIRES / ACCESSORIES / ACESSÓRIOS

+ INFO PAG. 276

⚡ 220-240V

Hz 50-60Hz

∠ 30°

🌿 >80

↕ +90° / -90°

↻ +135° / -135°

☐ AL

☒ ALAN

▨ VT

↑ Carril



MADE IN SPAIN  
Desing by PRILUX



▮	W <sub>LED</sub>	W <sub>T</sub>	⎓	ϕ <sub>LED</sub>	ϕ <sub>T</sub>	K	∞
205399*	13W	16W	380mA	2.137lm	1.997lm	3.000K	N
205405*	13W	16W	380mA	2.249lm	2.102lm	4.000K	N
205375*	28W	32W	750mA	3.573lm	3.340lm	3.000K	N
205382*	28W	32W	750mA	3.761lm	3.515lm	4.000K	N
205436*	13W	16W	380mA	2.137lm	1.997lm	3.000K	BL
205443*	13W	16W	380mA	2.249lm	2.102lm	4.000K	BL
205412*	28W	32W	750mA	3.573lm	3.340lm	3.000K	BL
205429*	28W	32W	750mA	3.761lm	3.515lm	4.000K	BL

BAJO PEDIDO / ON REQUEST / SUR COMMANDE / A PEDIDO

## K

CHROMALIFE® Museum

CHROMALIFE® Retail

CHROMALIFE® Health

CHROMALIFE® Fish

CHROMALIFE® Meat

CHROMALIFE® Bakery

\*Hasta fin de existencias\* • Until end of stock\* • Jusqu'à épuisement des stocks\* • Enquanto os estoques durarem



# Accesorios

Accessories

Accessoires

Acessórios

	Lynx	Lynx Line
207638	.	.
537933	.	.
538237	.	.
538244	.	.
150187		
204002		
210034		
232395		
204019		
210041		
232418		
381734		
381741		
232401		
232555		
378345		
383011		
232456		
232531		
232548		
232432		
204071		
210096		
232487		
204057		
210058		
232524		
204033		
210065		
232517		
204064		
210089		
232494		
204026		
210072		
232425		



207638

INC. 1ud

Alimentación en cable transparente, 3x0,75mm<sup>2</sup> y largo de 1m.  
Transparent power cable 3x0,75mm<sup>2</sup> and length of 1m.  
Cordon d'alimentation transparent 3x0,75mm<sup>2</sup> et la longueur de 1m.  
Cabo de alimentação transparente de 3x0,75mm<sup>2</sup> e comprimento de 1m.



537933

INC. 1ud

Alimentación en cable transparente, 5x0,75mm<sup>2</sup> y largo de 1m.  
Transparent power cable 5x0,75mm<sup>2</sup> and length of 1m.  
Cordon d'alimentation transparent 5x0,75mm<sup>2</sup> et la longueur de 1m.  
Cabo de alimentação transparente de 5x0,75mm<sup>2</sup> e comprimento de 1m.

Silent Led V

Voltore I

Voltore II



207638 INC. 2ud

Superficie  
Surface  
Surface  
Superficie



538244 INC. 2ud

Suspensión  
Suspended  
Suspendu  
Suspenso



150187 INC.4ud

Accesorio para techos de escayola de 0,5-20mm de espesor para modelos de 600x600mm.  
0,5-20mm thick plaster ceiling accessory for 600x600mm models.  
Accessoires plafonds 0,5-20mm d'épaisseur de plâtre pour les modèles 600x600mm.  
Tetos de gesso accesorias 0,5-20mm de espessura para os modelos 600x600mm.

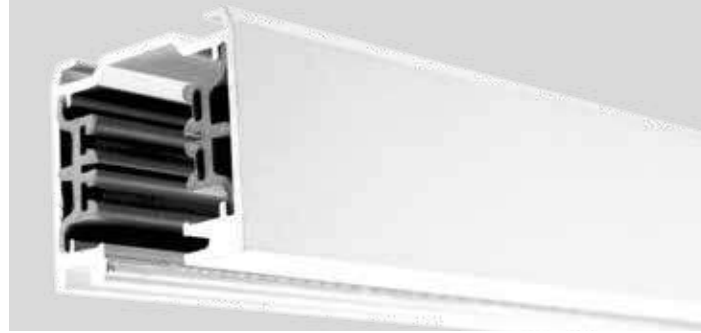
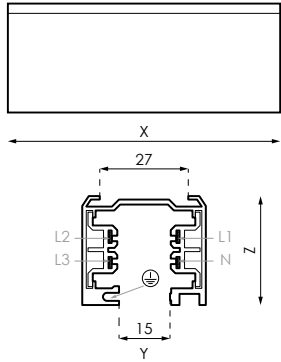

204002/210034/232395/204019/210041/232418/381734/381741/232401

378345/383011



232555

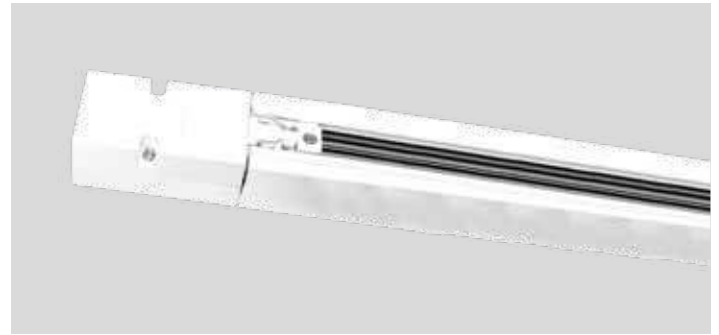

204071/210096/232487



232456



232531



232548



232432



204057/210058/232524



204033/210065/232517



204064/210089/232494

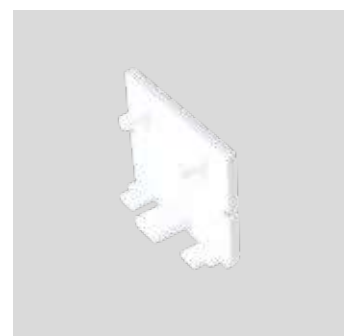

204026/210072/232425

			
204002	Carril electrificado 3F+N+TT 16A/ Electrified rail 3F+N+TT 16A/ Rail électrifié 3F+N+TT 16A/ Calha eletrificada 3F+N+TT 16A	BL	3.000 x 38 x 34mm
210034	Carril electrificado 3F+N+TT 16A/ Electrified rail 3F+N+TT 16A/ Rail électrifié 3F+N+TT 16A/ Calha eletrificada 3F+N+TT 16A	N	3.000 x 38 x 34mm
232395	Carril electrificado 3F+N+TT 16A/ Electrified rail 3F+N+TT 16A/ Rail électrifié 3F+N+TT 16A/ Calha eletrificada 3F+N+TT 16A	GR	3.000 x 38 x 34mm
204019	Carril electrificado 3F+N+TT 16A/ Electrified rail 3F+N+TT 16A/ Rail électrifié 3F+N+TT 16A/ Calha eletrificada 3F+N+TT 16A	BL	2.000 x 38 x 34mm
210041	Carril electrificado 3F+N+TT 16A/ Electrified rail 3F+N+TT 16A/ Rail électrifié 3F+N+TT 16A/ Calha eletrificada 3F+N+TT 16A	N	2.000 x 38 x 34mm
232418	Carril electrificado 3F+N+TT 16A/ Electrified rail 3F+N+TT 16A/ Rail électrifié 3F+N+TT 16A/ Calha eletrificada 3F+N+TT 16A	GR	2.000 x 38 x 34mm
381734	Carril electrificado 3F+N+TT 16A/ Electrified rail 3F+N+TT 16A/ Rail électrifié 3F+N+TT 16A/ Calha eletrificada 3F+N+TT 16A	BL	1.000 x 38 x 34mm
381741	Carril electrificado 3F+N+TT 16A/ Electrified rail 3F+N+TT 16A/ Rail électrifié 3F+N+TT 16A/ Calha eletrificada 3F+N+TT 16A	N	1.000 x 38 x 34mm
232401	Carril electrificado 3F+N+TT 16A/ Electrified rail 3F+N+TT 16A/ Rail électrifié 3F+N+TT 16A/ Calha eletrificada 3F+N+TT 16A	GR	1.000 x 38 x 34mm
232555	Conector flexible con acometida/ Flexible connector with feeder function/ Connecteur flexible avec fonction d'alimentation/ Conector flexível com função de alimentador	GR	-
378345	Adaptador de superficie VOLTRE I/ Surface adapter VOLTRE I/ Adaptateur surface VOLTRE I/ Adaptador de superficie VOLTRE I	BL	-
383011	Adaptador de superficie VOLTRE I/ Surface adapter VOLTRE I/ Adaptateur surface VOLTRE I/ Adaptador de superficie VOLTRE I	N	-
232456	Kit suspension/ Suspension kit/ Kit suspension/ Kit suspensão	GR	2.000mm
232531	Conector exterior en T con acometida/ External T-connector with feeder function/ Connecteur en T externe avec la fonction d'alimentation/ T-conector exterior com função de alimentador	GR	-
232548	Conector exterior en X con acometida/ External X-connector with feeder function/ Connecteur en X externe avec la fonction d'alimentation/ X-conector exterior com função de alimentador	GR	-
232432	Fijación a techo para carril/ Fixing to the ceiling for electrical track Fixation au plafond pour le rail électrique/ Fixação para o teto para trilho elétrico	GR	-
204071	Alimentador electrico lateral / Lateral electrical feeder/ Latérale d'alimentation électrique/ Alimentador elétrico laterais	BL	-
210096	Alimentador electrico lateral / Lateral electrical feeder/ Latérale d'alimentation électrique/ Alimentador elétrico laterais	N	-
232487	Alimentador electrico lateral / Lateral electrical feeder/ Latérale d'alimentation électrique/ Alimentador elétrico laterais	GR	-
204057	Conector exterior en L con acometida/ External L-connector with feeder function/ Connecteur en L avec la fonction d'alimentation/ L-conector exterior com função de alimentador	BL	-
210058	Conector exterior en L con acometida/ External L-connector with feeder function/ Connecteur en L avec la fonction d'alimentation/ L-conector exterior com função de alimentador	N	-
232524	Conector exterior en L con acometida/ External L-connector with feeder function/ Connecteur en L avec la fonction d'alimentation/ L-conector exterior com função de alimentador	GR	-
204033	Conector lineal exterior con acometida/ External lineal connector with feeder function/ Connecteur linéaire externe avec la fonction d'alimentation/ Conector linear externo com função de alimentador	BL	-
210065	Conector lineal exterior con acometida/ External lineal connector with feeder function/ Connecteur linéaire externe avec la fonction d'alimentation/ Conector linear externo com função de alimentador	N	-
232517	Conector lineal exterior con acometida/ External lineal connector with feeder function/ Connecteur linéaire externe avec la fonction d'alimentation/ Conector linear externo com função de alimentador	GR	-
204064	Conector lineal interior con acometida/ Indoor lineal connector with feeder function/ Connecteur linéaire intérieure avec la fonction d'alimentation/ Conector linear interior com função de alimentador	BL	-
210089	Conector lineal interior con acometida/ Indoor lineal connector with feeder function/ Connecteur linéaire intérieure avec la fonction d'alimentation/ Conector linear interior com função de alimentador	N	-
232494	Conector lineal interior con acometida/ Indoor lineal connector with feeder function/ Connecteur linéaire intérieure avec la fonction d'alimentation/ Conector linear interior com função de alimentador	GR	-
204026	Tapa final/ End cap/ Capuchon/ Tapa final	BL	-
210072	Tapa final/ End cap/ Capuchon/ Tapa final	N	-
232425	Tapa final/ End cap/ Capuchon/ Tapa final	GR	-





# Realizaciones

Realizations

Réalisations

Realizações

A photograph of an Aldi store entrance. The building has a dark grey facade with the 'ALDI' logo in large, blue, outlined letters. Below the logo is a red horizontal bar. The entrance consists of large glass doors and windows. The reflection on the glass shows a residential building with a red roof. The sky is clear and blue.

ALDI

C. Comercial  
Algete

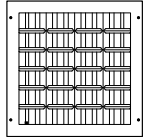

Silent V IP65









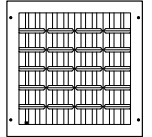

Silent V IP65





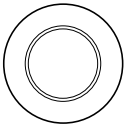





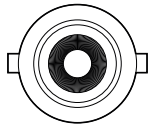





TACIÓN  
DE  
A



# Arquitectural

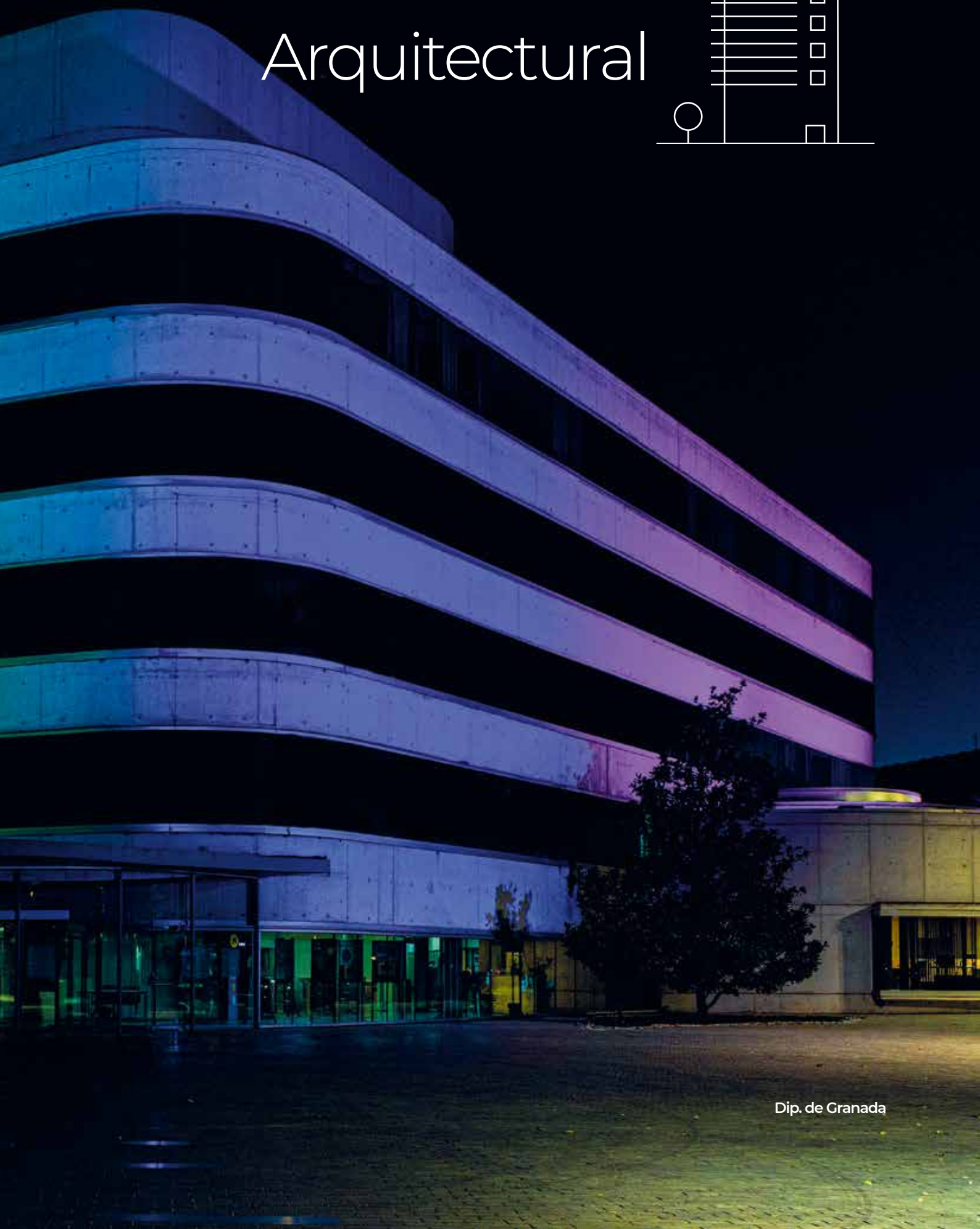
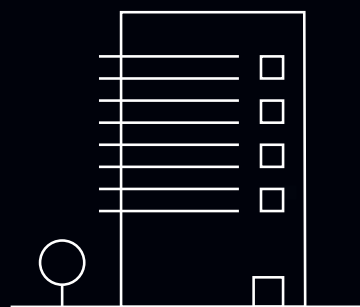



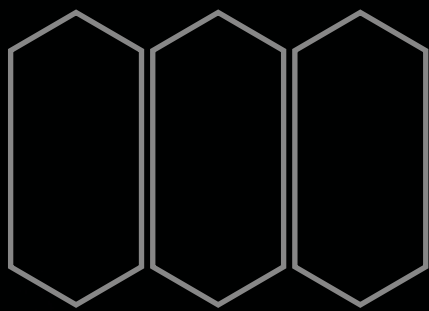

Hexagon  
Play RGBW



# Hexagon

## Play RGBW

**N/** HEXAGON RGBW reproduce una amplísima gama de colores que bañan cualquier superficie cambiando completamente la apariencia de edificios, toda clase de recintos, monumentos e infraestructuras. La iluminación arquitectónica no volverá a ser la misma, edificios con identidad propia que llevan la imagen de marca a otro nivel.

Gracias a la regulación DALI y DMX el concepto de iluminación dinámica se hace realidad. HEXAGON RGBW permite cambios y combinaciones de color programados que junto con la sincronización musical eleva la iluminación a una nueva dimensión. Cada edificio, cada espacio, cada ambiente, es un lienzo en blanco en el que se proyectan miles de colores convirtiéndose en un show de luces y sonido, un ente con vida propia de piel cambiante, objeto de todas las miradas, que se mueve, impacta, interactúa y no deja indiferente al público.

**E/** HEXAGON RGBW reproduces a wide range of colors that bathe any surface, completely changing the appearance of buildings, all kinds of venues, monuments and infrastructures. Architectural lighting will never be the same, buildings with their own identity that take the brand image to another level.

Thanks to DALI and DMX regulation, the concept of dynamic lighting becomes a reality. HEXAGON RGBW allows programmed color changes and combinations that, together with musical synchronization, elevate lighting to a new dimension. Each building, each space, each environment, is a blank canvas on which thousands of colors are projected, becoming a show of lights and sound, an entity with its own life of changing skin, the object of all eyes, that moves, it impacts, interacts and does not leave the public indifferent.





**F/** HEXAGON RGBW reproduit une large gamme de couleurs qui baignent n'importe quelle surface, changeant complètement l'apparence des bâtiments, des lieux de toutes sortes, des monuments et des infrastructures. L'éclairage architectural ne sera plus jamais le même, des bâtiments avec leur propre identité qui portent l'image de marque à un autre niveau.

Grâce à la régulation DALI et DMX, le concept d'éclairage dynamique devient une réalité. HEXAGON RGBW permet des changements et des combinaisons de couleurs programmés qui, associés à la synchronisation musicale, élèvent l'éclairage à une nouvelle dimension. Chaque bâtiment, chaque espace, chaque environnement, est une toile vierge sur laquelle des milliers de couleurs sont projetées, devenant un spectacle de lumières et de sons, une entité avec sa propre vie de peau changeante, l'objet de tous les regards, qui bouge, il impacte, interagit et ne laisse pas le public indifférent.

**P/** HEXAGON RGBW reproduz uma ampla gama de cores que banham qualquer superfície, mudando completamente a aparência de edifícios, todo tipo de espaços, monumentos e infraestruturas. A iluminação arquitetónica nunca mais será a mesma, edifícios com identidade própria que levam a imagem da marca a outro patamar.

Grças à regulação DALI e DMX, o conceito de iluminação dinâmica torna-se realidade. O HEXAGON RGBW permite mudanças e combinações de cores programadas que, juntamente com a sincronização musical, elevam a iluminação a uma nova dimensão. Cada edifício, cada espaço, cada ambiente, é uma tela em branco na qual se projetam milhares de cores, tornando-se um espetáculo de luzes e sons, uma entidade com vida própria de pele em mudança, objeto de todos os olhos, que se move, impacta, interage e não deixa o público indiferente.

### RGBW

1X 2X		1X 2X	
Box Integrado		Box Remoto	
PEXL0M	S025L0M	PEXL0M	S025L0M
PINL0M	S074L0M	PINL0M	S074L0M
AEXL0M	S137L0M	AEXL0M	S137L0M
AINL0M	S154L0M	AINL0M	S154L0M
S014L0M	-	S014L0M	-
			
			
Dinámico		-	

## TECNOLOGÍAS/ TECHNOLOGIES/ TECHNOLOGIES/ TECNOLOGIAS

+ INFO PAG. 21



De serie/ Serial/ De série/ Em série



### Hexagon Play RGBW

**Ñ/** Proyección de color tanto interior como exterior. Pensada para iluminar por inundación el espacio o superficie deseada, pero con ópticas especiales que permiten iluminación rasante de largas distancias. (Ej: Espacios deportivos).

**E/** Color projection both inside and outside. Designed to illuminate the desired space or surface by flooding, but with special optics that allow grazing lighting over long distances. (Ex: Sports spaces).

**F/** Projection de couleur, aussi bien à l'intérieur qu'à l'extérieur. Conçue pour éclairer un espace souhaitée par projection, mais avec des optiques spéciales permettant l'éclairage rasant de longues distances. (Par ex. espaces sportifs).

**P/** Projeção de cor tanto interior como exterior. Pensada para iluminar por inundação do espaço ou superfície pretendida, mas com ópticas especiais que permitem iluminação rasante de longas distâncias. (Ex: Espaços desportivos).



### Hexagon Play RGBW Remoto

**Ñ/** Proyección minimalista de color, permitiendo separar la electrónica del módulo facilitando las tareas de mantenimiento.(Ej: Pequeños recintos deportivos).

**E/** Minimalist color projection, allowing the electronics to be separated from the module, facilitating maintenance tasks. (Ex: Small sports venues).

**F/** Projection minimaliste de couleur, permettant de séparer l'électronique du luminaire et de l'éloigner de la vue des assistants. (Par ex. petites enceintes sportives).

**P/** Projeção minimalista de cor, permitindo separar a eletrônica do módulo, o que facilita as tarefas de manutenção.(Ex: Pequenos recintos desportivos).



# Hexagon

## Play RGBW



	220-240V
	50-60Hz
	0,98
	700mA
	PEXL0M
	>80 (Blanco)
	K RGBW (W: 4000K)
	0.0%
	RAL 9007
	PC-T
	AL iap
	Overstorm
	HCB
	TESS



		$W_{LED}$	$W_T$	$\phi_{LED}$	$\phi_T$		
586344	1x	82W	92W	6.653lm	5.554lm	40	DALI
586351	1x	82W	92W	6.653lm	5.554lm	40	DMX
586368	1x	82W	92W	6.653lm	5.554lm	40	DINÁMICO
586375	2x	164W	184W	13.306lm	11.108lm	80	DALI
586382	2x	164W	184W	13.306lm	11.108lm	80	DMX

Soluciones  
Solutions  
Des solutions  
Soluções

Cora Sport  
Pág. 42



Necesita driver DALI  
You need DALI driver  
Vous avez besoin d'un driver DALI  
Você precisa da driver DALI

⚡ 220-240V

Hz 50-60Hz

Φ 0,98

🔌 700mA

🌀 PEXL0M

🌸 >80 (Blanco)

K RGBW (W: 4000K)

☀️ 0.0%

🌀 RAL 9007

🔧 PC-T

📄 ALiap

⚡ Overstorm

🛡️ HCB

🛡️ TESS



MADE IN SPAIN  
Desing by PRILUX

# Hexagon Play RGBW Remoto



### G.O.HEXAGON

📊	🔧	🔌	W <sub>LED</sub>	Φ <sub>LED</sub>	Φ	☀️
586399	ARQUITEC 1x	4x700mA dc máx.	82W máx.	6.653lm	5.554lm	40
586405	LIRA 1x	4x700mA dc máx.	82W máx.	6.653lm	5.554lm	40
586429	LIRA 2x	4x700mA dc máx.	164W máx.	13.306lm	11.108lm	80

### BOX HEXAGON

📊	🔧	W <sub>T</sub>	⚡ <sub>IN</sub>	Hz	🔌 <sub>OUT</sub>	⚡ <sub>OUT</sub>	🌀
452656	1x	94W	220-240V ac	50-60Hz	4x700mA dc	4x33,6 Vdc máx.	DALI
452663	1x	94W	220-240V ac	50-60Hz	4x700mA dc	4x33,6 Vdc máx.	DMX
480062	2x	188W	220-240V ac	50-60Hz	4x700mA dc	4x67,2 Vdc máx.	DALI
480079	2x	188W	220-240V ac	50-60Hz	4x700mA dc	4x67,2 Vdc máx.	DMX

### AVISO / WARNING / AVERTISSEMENT / AVISO

**Ñ** / Los sistemas de instalación remoto se componen, de manera indivisible, de proyectores HEXAGON REMOTO conectados a un BOX DE ALIMENTACIÓN (No incluido en la luminaria)

Es necesaria la adquisición del BOX DE ALIMENTACIÓN a parte.

Consulte con el su comercial de zona la mejor combinación adaptada a su instalación.

**E** / The remote installation systems are made up, indivisible, of REMOTE HEXAGON projectors connected to a POWER SUPPLY BOX (Not included in the luminaire)

It is necessary to purchase the separate POWER SUPPLY BOX.

Consult with your local sales representative the best combination adapted to your installation.

**F** / Les systèmes d'installation à distance RSSY sont composés, de manière indivisible, de projecteurs RSSY HEXAGON reliés à un POWER BOX (non inclus dans le luminaire).

Il est nécessaire d'acheter la POWER BOX séparément.

Renseignez-vous auprès de votre représentant commercial local pour la meilleure combinaison adaptée à votre installation.

**P** / Os sistemas de instalação remota RSSY são compostos, indivisivelmente, de projectores RSSY HEXAGON ligados a uma CAIXA DE ENERGIA (não incluídos na luminária).

É necessário comprar a POWER BOX separadamente.

Verifique com seu representante de vendas local a melhor combinação adaptada à sua instalação.

Soluciones  
Solutions  
Des solutions  
Soluções

Cora Sport  
Pág. 42



Necesita driver DALI  
You need DALI driver  
Vous avez besoin d'un driver DALI  
Você precisa da driver DALI

# Hexagon

## Play RGBW

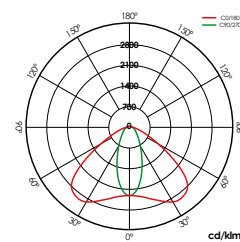

PEXL0M

BAJO PEDIDO / ON REQUEST / SUR COMMANDE / A PEDIDO



Bluetooth



PINL0M	S025L0M
AEXL0M	S074L0M
AINL0M	S137L0M
S014L0M	S154L0M

ACCESORIOS / ACCESSOIRES / ACCESSORIES / ACESSÓRIOS

+ INFO PAG. 308

452311 INC. 1UD

Aletas móviles 1X  
Mobile fins 1X  
Palmes mobiles 1X  
Palas orientáveis 1X

452687 INC. 1UD

Kit conexión RGBW 5m.  
RGBW connection kit 5m.  
TKit de connexion RGBW 5m.  
Kit de conexão 5m. RGBW

452335 INC. 1UD

Visera 1X  
Visor 1X  
Visière 1X  
Viseira 1X

471428 INC. 1UD

Kit conexión RGBW 7m.  
RGBW connection kit 7m.  
Kit de connexion RGBW 7m.  
Kit de conexão 7m RGBW.

452670 INC. 1UD

Kit conexión RGBW 3m.  
RGBW connection kit 3m.  
Kit de connexion RGBW 3m.  
Kit de conexão 3m. RGBW

471596 INC. 1UD

Kit conexión RGBW 10m.  
RGBW connection kit 10m.  
Kit de connexion RGBW 10m.  
Kit de conexão 10m RGBW.

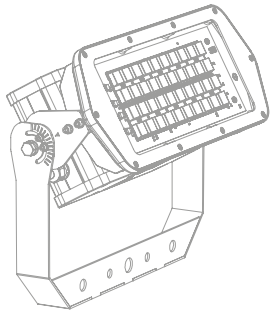

Box Integrado/  
Integrated Box/  
Box Intégré/  
Box Integrado/

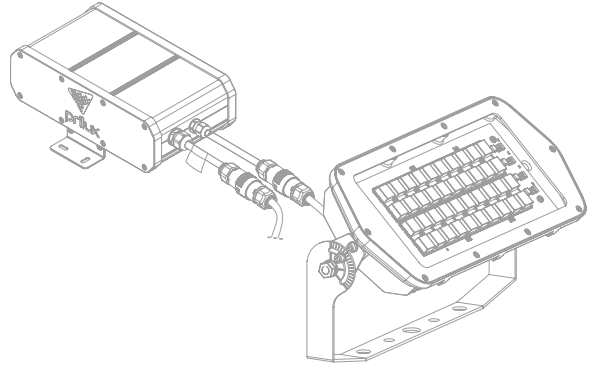

Box Remoto/  
Remote Box/  
Box Déporté/  
Box Remoto/

## Box Integrado

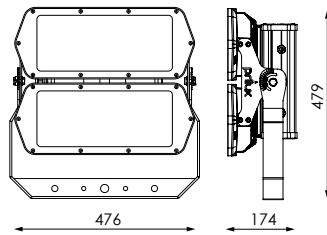
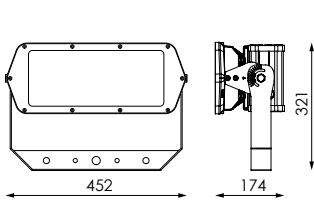

	↕	⊞	⚖	▭
1X	452 x 321 x 174mm		9kg	0,082m <sup>2</sup>
2X	476 x 479 x 174mm		17kg	0,169m <sup>2</sup>

## Box Remoto

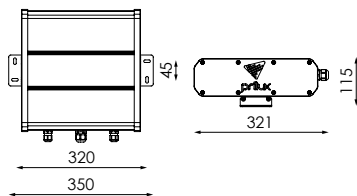
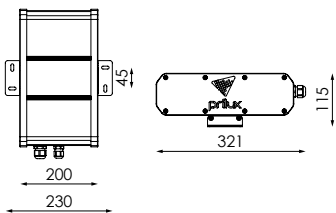
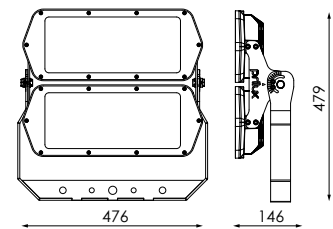
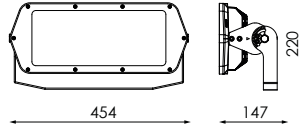
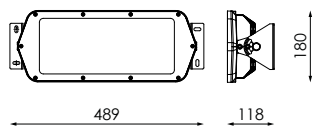

	↕	⊞	⚖	▭
<b>G.O. HEXAGON</b>				
ARQUITEC	460 x 343 x 174mm		5,0kg	0,082m <sup>2</sup>
LIRA 1X	489 x 180 x 118mm		5,0kg	0,082m <sup>2</sup>
LIRA 2X	476 x 479 x 146mm		12,5kg	0,169m <sup>2</sup>
<b>BOX HEXAGON</b>				
1X	230 x 321 x 115mm		3,0kg	-
2X	350 x 321 x 115mm		4,5kg	-



# Tanek

## ARQ

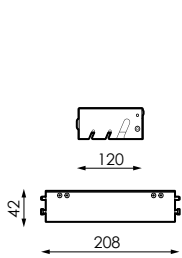

BOX TANEK ARQ

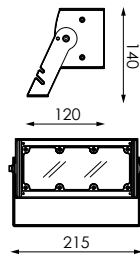

G.O.P. TANEK ARQ

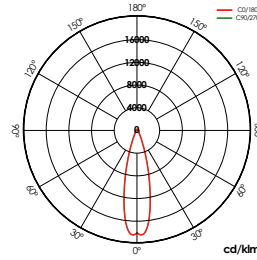

S027L0P



### Montaje Box Integrado

Integrated Box Assembly/ Ensemble Box Intégrée/  
Montagem Box Integrado

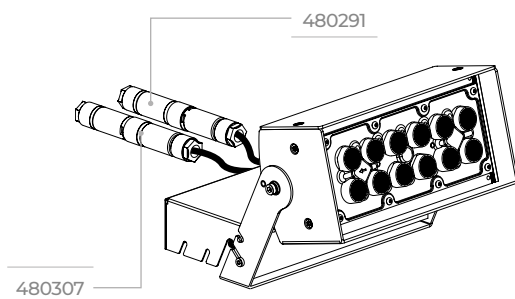

### Montaje Box Remoto

Remote Box Assembly/ Ensemble Box A Distance/  
Montagem Box Remoto

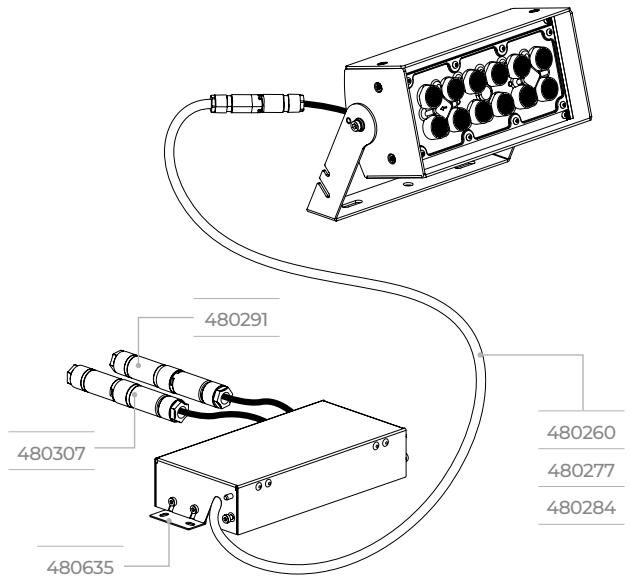

### ACCESORIOS / ACCESSOIRES / ACCESSORIES / ACESSÓRIOS

+ INFO PAG. 308

480246	480253	480307	480291
Rejilla Grating Grille Grelha	Aletas verticales Vertical fins Ailettes verticales Barbatanas verticais	Conector IP67 Alimentación. IP67 Connector Power supply. Connecteur IP67 Alimentation. Conector IP67 Fonte de alimentação.	Conector IP67 Regulación. IP67 Connector Regulation. Connecteur IP67 Réglementation. Conector IP67 Regulação.
480260	480277	480284	480635
Kit conexión Tanek ARQ-Box 5m. Tanek ARQ- Box connection kit 5m. Tanek ARQ-Box kit de connexion 5m. Tanek ARQ-Box Kit de conexão de 5m.	Kit conexión Tanek ARQ-Box 10m. Tanek ARQ- Box connection kit 10m. Tanek ARQ-Box kit de connexion 10m. Tanek ARQ-Box Kit de conexão de 10m.	Kit conexión Tanek ARQ-Box 20m. Tanek ARQ- Box connection kit 20m. Tanek ARQ-Box kit de connexion 20m. Tanek ARQ-Box Kit de conexão de 20m.	Soporte Box Tanek ARQ Remoto. Remote Box Tanek Support. Box à distance Support Tanek ARQ. Remote Tanek ARQ Box Suporte.

⚡ 220-240V

Hz 50-60Hz

Φ 0,98

☀️ 12

🌿 >70

K 4.000K

📦 FE

📏 0,018m²



MADE IN SPAIN  
Desing by PRILUX



#### G.O TANEK ARQ

Barcode	Icon	W <sub>LED</sub>	Φ <sub>LED</sub>	Φ <sub>T</sub>	☀️	🌀	📏
478267	1.400mA dc máx.	52W máx.	6.892lm	5.719lm	S027LOP	RAL9007	1,8kg
481984	1.400mA dc máx.	52W máx.	6.892lm	5.719lm	S027LOP	RAL9010	1,8kg
478274	1.400mA dc máx.	52W máx.	6.892lm	6.168lm	S060LOP	RAL9007	1,8kg
481991	1.400mA dc máx.	52W máx.	6.892lm	6.168lm	S060LOP	RAL9010	1,8kg
478281	1.400mA dc máx.	52W máx.	6.892lm	6.247lm	S093LOP	RAL9007	1,8kg
482004	1.400mA dc máx.	52W máx.	6.892lm	6.247lm	S093LOP	RAL9010	1,8kg
478298	1.400mA dc máx.	52W máx.	6.892m	5.919lm	S146LOP	RAL9007	1,8kg
482011	1.400mA dc máx.	52W máx.	6.892lm	5.919lm	S146LOP	RAL9010	1,8kg

#### BOX TANEK ARQ

Barcode	W <sub>T</sub>	⚡ <sub>IN</sub>	Hz	📏 <sub>OUT</sub>	⚡ <sub>OUT</sub>	🌀	🕒	📏
478250	57W	220-240V ac	50-60Hz	1.400mA dc	53Vdc máx.	RAL9007	DALI	1,2kg
481977	57W	220-240V ac	50-60Hz	1.400mA dc	53Vdc máx.	RAL9010	DALI	1,2kg

#### BAJO PEDIDO / ON REQUEST / SUR COMMANDE / A PEDIDO



K

Ra ≥70

3.000K

5.000K

Ra ≥80

3.000K

4.000K

Ra ≥90

4.000K

#### AVISO / WARNING / AVERTISSEMENT / AVISO

**Ñ** / Los sistemas de instalación remoto se componen, de manera indivisible, de proyectores HEXAGON REMOTO conectados a un BOX DE ALIMENTACIÓN (No incluido en la luminaria)

Es necesaria la adquisición del BOX DE ALIMENTACIÓN a parte.

Consulte con el su comercial de zona la mejor combinación adaptada a su instalación..

**E** / The RSSY remote installation systems are indivisibly composed of HEXAGON RSSY floodlights connected to a POWER BOX (not included in the luminaire).

The POWER BOX must be purchased separately.

Check with your local sales representative for the best combination adapted to your installation.

**F** / Les systèmes d'installation à distance RSSY sont composés, de manière indivisible, de projecteurs RSSY HEXAGON reliés à un POWER BOX (non inclus dans le luminaire).

Il est nécessaire d'acheter la POWER BOX séparément.

Renseignez-vous auprès de votre représentant commercial local pour la meilleure combinaison adaptée à votre installation.

**P** / Os sistemas de instalação remota RSSY são compostos, indivisivelmente, de projectores RSSY HEXAGON ligados a uma CAIXA DE ENERGIA (não incluídos na luminária).

É necessário comprar a POWER BOX separadamente.

Verifique com seu representante de vendas local a melhor combinação adaptada à sua instalação.

# Tanek

## ARQ RGBW

<b>N</b> NEW	CI	CO / IP67 BOX / IP55	CO / IK10 BOX / IK07	L90B10 184.000h	-20~+50°C
-----------------	----	-------------------------	-------------------------	--------------------	-----------

### Montaje Box

Box Assembly/ Ensemble Box/ Montagem Box

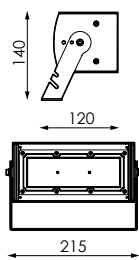
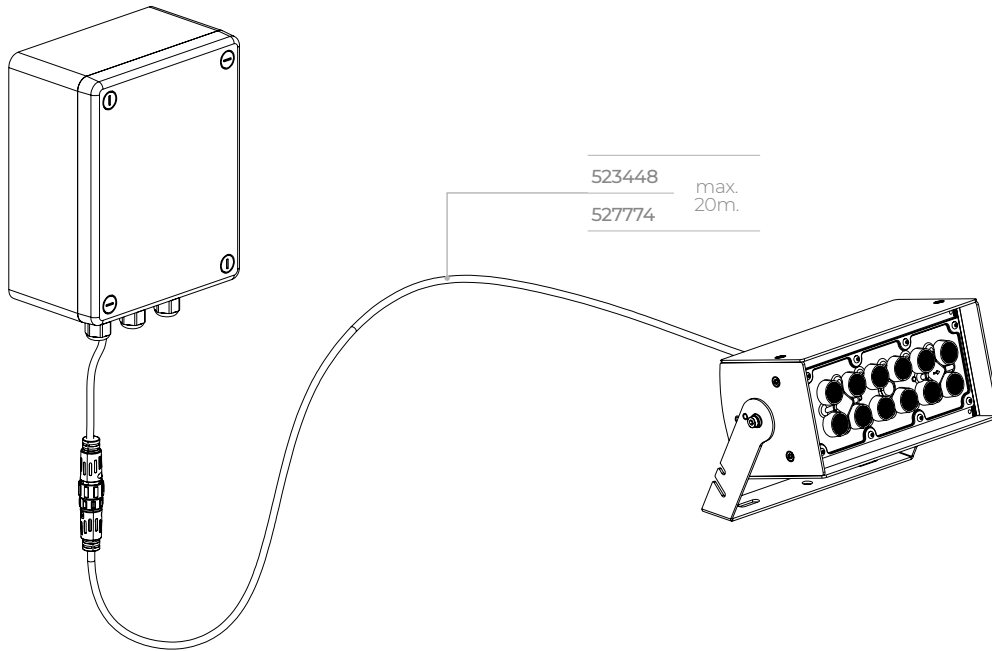

G.O.P. TANEK ARQ RGBW

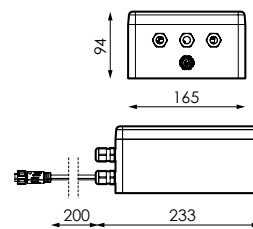

BOX TANEK ARQ RGBW

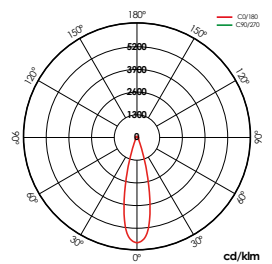

S0251IP



### ACCESORIOS / ACCESSOIRES / ACCESSORIES / ACESSÓRIOS

+ INFO PAG. 308

**N 523448** INC. 1ud

Kit conexión Tanek ARQ RGBW-Box 3m.  
Tanek ARQ RGBW-Box connection kit 3m.  
Tanek ARQ RGBW-Box kit de conexión 3m.  
Tanek ARQ RGBW-Box Kit de conexão dee 3m.

**N 527774** INC. 1ud

Kit conexión Tanek ARQ RGBW-Box 10m.  
Tanek ARQ RGBW-Box connection kit 10m.  
Tanek ARQ RGBW-Box kit de conexión 10m.  
Tanek ARQ RGBW-Box Kit de conexão dee 10m.

**N 561280** INC. 5ud

Terminador DMX 120 OHM  
DMX 120 OHM Terminator  
Terminaison DMX 120 OHM  
Terminador DMX 120 OHM

⚡ 220-240V

Hz 50-60Hz

Φ 0,95

💡 12

🌸 >80 (Blanco)

K RGBW (W:4.000K)

📦 FE (G.OP. Tanek)  
PS (Box Tanek)

📏 0,018m<sup>2</sup>

📦 2kg (G.OP. Tanek)  
1,25kg (Box Tanek)

🌀 DMX (RDM)



MADE IN SPAIN  
Desing by PRILUX



#### G.OP. TANEK ARQ RGBW

📏	🔌	W <sub>LED</sub>	Φ <sub>LED</sub>	Φ <sub>T</sub>	💡	🌀
583022	4x850mA dc máx.	29W máx.	2.438lm	1.823lm	S025IIP	RAL9007
583039	4x850mA dc máx.	29W máx.	2.438lm	1.823lm	S025IIP	RAL9010
583046	4x850mA dc máx.	29W máx.	2.438lm	2.019lm	S059IIP	RAL9007
583053	4x850mA dc máx.	29W máx.	2.438lm	2.019lm	S059IIP	RAL9010
583008	4x850mA dc máx.	29W máx.	2.438lm	2.035lm	S094IIP	RAL9007
583015	4x850mA dc máx.	29W máx.	2.438lm	2.035lm	S094IIP	RAL9010
583060	4x850mA dc máx.	29W máx.	2.438lm	1.858lm	S151IIP	RAL9007
583077	4x850mA dc máx.	29W máx.	2.438lm	1.858lm	S151IIP	RAL9010

#### BOX TANEK ARQ RGBW

📏	W <sub>T</sub>	⚡ <sub>IN</sub>	Hz	🔌 <sub>OUT</sub>	⚡ <sub>OUT</sub>
523356	38W máx.	220-240V ac	50-60Hz	4x850mA dc	4x11,2V dc máx.

### AVISO / WARNING / AVERTISSEMENT / AVISO

**Ñ** / Los sistemas de instalación remoto se componen, de manera indivisible, de proyectores HEXAGON REMOTO conectados a un BOX DE ALIMENTACIÓN (No incluido en la luminaria)

Es necesaria la adquisición del BOX DE ALIMENTACIÓN a parte.

Consulte con el su comercial de zona la mejor combinación adaptada a su instalación..

**E** / The RSSY remote installation systems are indivisibly composed of HEXAGON RSSY floodlights connected to a POWER BOX (not included in the luminaire).

The POWER BOX must be purchased separately.

Check with your local sales representative for the best combination adapted to your installation.

**F** / Les systèmes d'installation à distance RSSY sont composés, de manière indivisible, de projecteurs RSSY HEXAGON reliés à un POWER BOX (non inclus dans le luminaire).

Il est nécessaire d'acheter la POWER BOX séparément.

Renseignez-vous auprès de votre représentant commercial local pour la meilleure combinaison adaptée à votre installation.

**P** / Os sistemas de instalação remota RSSY são compostos, indivisivelmente, de projectores RSSY HEXAGON ligados a uma CAIXA DE ENERGIA (não incluídos na luminária).

É necessário comprar a POWER BOX separadamente.

Verifique com seu representante de vendas local a melhor combinação adaptada à sua instalação.





# LED Pad

## Avant

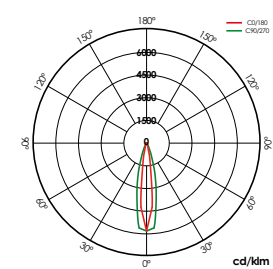
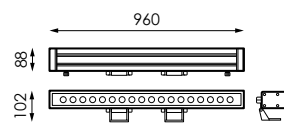

40W

Hz 50-60Hz

△ 42°

💡 18

🌿 >80

🌀 RAL 9007

📏 VT

📦 AL

← Sup. Lateral



📊	⚡	$W_{LED}$	$W_T$	$\phi_{LED}$	$\phi_T$	K
410137	100-240V	37W	40W	2.803lm	2.273lm	3.000K
410144	100-240V	37W	40W	2.954lm	2.387lm	4.000K
<b>N</b> 591812	220-240V	42W	45W	3.924lm	3.319lm	3.000K
<b>N</b> 591829	220-240V	42W	45W	4.017lm	3.485lm	4.000K

# LED Pad

## Avant RGBW

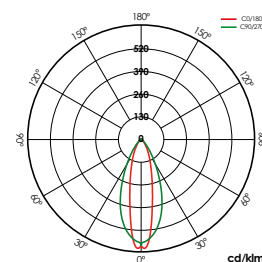
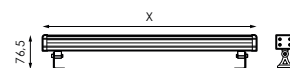

24W

### ACCESORIOS / ACCESSOIRES / ACCESSORIES / ACESSÓRIOS

+ INFO PAG. 308

565325 INC. 1ud

Tapón final aluminio  
Aluminum end cap  
Embout en aluminium  
Tampo final de alumínio

516013 INC. 1ud

Conector T Led Pad Avant RGBW  
Led Pad Avant RGBW T connector  
Connecteur Led Pad Avant RGBW T  
Conector Led Pad Avant RGBW T

588911

Extensión fuente de alimentación  
0,5m  
Power supply extension 0,5m  
Rallonge d'alimentation 0,5m  
Extensão da fonte de alimentação  
0,5m

588928 INC. 1ud

Extensión fuente de alimentación  
1m  
Power supply extension 1m  
Rallonge d'alimentation 1m  
Extensão da fonte de alimentação  
1m

488447 INC. 1ud

Fuente alimentación 60W 24V con  
conector (alimenta 2 Led Pad)  
Power supply 60W 24V with  
connector (powers 2 Led Pad)  
Alimentation 60W 24V avec  
connecteur (alimente 2 Led Pad)  
Fonte de alimentação 60W 24V com  
conector (alimenta 2 Led Pad)

488464 INC. 1ud

Fuente alimentación 100W 24V con  
conector (alimenta 3 Led Pad)  
Power supply 100W 24V with  
connector (powers 3 Led Pad)  
Alimentation 100W 24V avec  
connecteur (alimente 3 Led Pad)  
Fonte de alimentação 100W 24V  
com conector (alimenta 3 Led Pad)

485135 INC. 1ud

Controlador Master DMX512 1  
universo  
Master DMX512 controller 1 universe  
Univers maître du contrôleur  
DMX512 1  
Controlador DMX512 mestre 1  
universo

529037 INC. 1ud

Controlador Master DMX512 2  
universos  
Master DMX512 controller 2 universe  
Univers maître du contrôleur  
DMX512 2  
Controlador DMX512 mestre 2  
universo

529327 INC. 1ud

Extensión 0,5m 5 PIN DMX Led Pad  
Avant RGBW  
Extension 0,5m 5 PIN DMX Led Pad  
Avant RGBW  
Rallonge 0,5m 5 PIN DMX Led Pad  
Avant RGBW  
Extensão 0,5m 5 PIN DMX Led Pad  
Avant RGBW

516020 INC. 1ud

Extensión 3m DMX Led Pad Avant  
RGBW  
Extension 3m DMX Led Pad Avant  
RGBW  
Rallonge 3m DMX Led Pad Avant  
RGBW  
Extensão 3m DMX Led Pad Avant  
RGBW

391535 INC. 1ud

Extensión fuente de alimentación  
3m  
Power supply extension 3m  
Rallonge d'alimentation 3m  
Extensão da fonte de alimentação  
3m

588942 INC. 1ud

Extensión fuente de alimentación  
5m  
Power supply extension 5m  
Rallonge d'alimentation 5m  
Extensão da fonte de alimentação  
5m

481687 INC. 1ud

Fuente alimentación 150W 24V con  
conector (alimenta 5 Led Pad)  
Power supply 150W 24V with  
connector (powers 5 Led Pad)  
Alimentation 150W 24V avec  
connecteur (alimente 5 Led Pad)  
Fonte de alimentação 150W 24V  
com conector (alimenta 5 Led Pad)

481694 INC. 1ud

Fuente alimentación 200W 24V con  
conector (alimenta 7 Led Pad)  
Power supply 200W 24V with  
connector (powers 7 Led Pad)  
Alimentation 200W 24V avec  
connecteur (alimente 7 Led Pad)  
Fonte de alimentação 200W 24V  
com conector (alimenta 7 Led Pad)

### INFORMACIÓN / INFORMATION / INFORMATION / INFORMAÇÕES

Ñ/ Sin mando a distancia.  
Profundidad máxima de  
instalación 2 metros.

E/ Do not connect more than 8  
luminaires in series.

F/ Ne pas connecter plus de 8  
luminaires en série.

P/ Não conecte mais de 8  
luminárias em série.

⚡ 24V dc

Hz 50-60Hz

△ 45°

☀ 18

🌿 >80 (Blanco)

K RGBW

⊙ RAL 9007



▨ VT

📄 AL

⊙ DMX

← Sup. Lateral



	$W_{LED}$	$\phi_{LED}$	$\phi_T$	
<b>N</b> 581271	8W	490,31mm	1.0161m	300 x 76,5mm
490153	24W	1.4711m	1.0161m	1.000 x 76,5mm



# Accesorios

Accessories

Accessoires

Acessórios

	Hexagon RGBW	Hexagon RGBW Remoto	Tanek ARQ	LED Pad Avant RGBW
452311	.	.		
452335	.	.		
452670		.		
471428		.		
471596		.		
452687		.		
480246			.	
480253			.	
480307			.	
480291			.	
480260			.	
480277			.	
480284			.	
480635			.	
485135				.
529037				.
473989				.
527644				.
565325				.
473699				.
529327				.
516020				.
588911				.
588928				.
391535				.
588942				.
488447				.
488464				.
481687				.
481694				.



452311 INC. 1ud

Aletas móveis 1X  
Mobile fins 1X  
Palmes mobiles 1X  
Palas orientáveis 1X



452335 INC. 1ud

Visera 1X  
Visor 1X  
Visière 1X  
Viseira 1X



452670 INC. 1ud

Kit conexão RGBW 3m.  
RGBW connection kit 3m.  
Kit de connexion RGBW 3m.  
Kit de conexão 3m. RGBW



452687 INC. 1ud

Kit conexão RGBW 5m.  
RGBW connection kit 5m.  
TKit de connexion RGBW 5m.  
Kit de conexão 5m. RGBW



471428 INC. 1ud

Kit connexion RGBW 7m.  
RGBW connection kit 7m.  
Kit de connexion RGBW 7m.  
Kit de conexão 7m RGBW.



471596 INC. 1ud

Kit connexion RGBW 10m.  
RGBW connection kit 10m.  
Kit de connexion RGBW 10m.  
Kit de conexão 10m RGBW.



480246

Rejilla  
Grating  
Grille  
Grelha



480253

Aletas verticales  
Vertical fins  
Ailettes verticales  
Barbatanas verticais



480307

Conector IP67 Alimentación.  
IP67 Connector Power supply.  
Connecteur IP67 Alimentation.  
Conector IP67 Fonte de alimentação.



480291

Conector IP67 Regulación.  
IP67 Connector Regulation.  
Connecteur IP67 Réglementation.  
Conector IP67 Regulação.



480260

Kit connexion Tanek ARQ-Box 5m.  
Tanek ARQ- Box connection kit 5m.  
Tanek ARQ-Box kit de connexion 5m.  
Tanek ARQ-Box Kit de conexão de 5m.



480277

Kit connexion Tanek ARQ-Box 10m.  
Tanek ARQ- Box connection kit 10m.  
Tanek ARQ-Box kit de connexion 10m.  
Tanek ARQ-Box Kit de conexão de 10m.



480284

Kit connexion Tanek ARQ-Box 20m.  
Tanek ARQ- Box connection kit 20m.  
Tanek ARQ-Box kit de connexion 20m.  
Tanek ARQ-Box Kit de conexão de 20m.



480635

Soporte Box Tanek ARQ Remoto.  
Remote Box Tanek Support.  
Box à distance Support Tanek ARQ.  
Remote Tanek ARQ Box Suporte.



N 523448

INC. 1ud

Kit connexion Tanek ARQ RGBW-Box 3m.  
Tanek ARQ RGBW- Box connection kit 3m.  
Tanek ARQ RGBW-Box kit de connexion 3m.  
Tanek ARQ RGBW-Box Kit de conexão de 3m.



N 527774

INC. 1ud

Kit connexion Tanek ARQ RGBW-Box 10m.  
Tanek ARQ RGBW- Box connection kit 10m.  
Tanek ARQ RGBW-Box kit de connexion 10m.  
Tanek ARQ RGBW-Box Kit de conexão de 10m.



N 561280

INC. 5ud

Terminador DMX 120 OHM  
DMX 120 OHM Terminator  
Terminaison DMX 120 OHM  
Terminador DMX 120 OHM



485135

INC. 1ud

Controlador Master DMX512 1 universo  
Master DMX512 controller 1 universe  
Univers maître du contrôleur DMX512 1  
Controlador DMX512 mestre 1 universo



529037

INC. 1ud

Controlador Master DMX512 2 universos  
Master DMX512 controller 2 universe  
Univers maître du contrôleur DMX512 2  
Controlador DMX512 mestre 2 universo



473989

INC. 1ud

Conector enchufable XLR IP67 3P  
NC3MXX-HD-D  
XLR plug-in connector IP67 3P  
NC3MXX-HD-D  
Connecteur XLR enfichable IP67 3P  
NC3MXX-HD-D  
Conector de encaixe XLR IP67 3P  
NC3MXX-HD-D



527644

INC. 1ud

Conector alimentación Jack DC macho 5.5mm  
5.5mm male DC Jack power connector  
Connecteur d'alimentation DC Jack 5,5 mm mâle  
Conector de alimentação DC Jack macho de 5,5 mm



565325

INC. 1ud

Tapón final aluminio  
Aluminum end cap  
Embout en aluminium  
Tampo final de alumínio



473699

INC. 1ud

Conector T Led Pad Avant RGBW  
Led Pad Avant RGBW T connector  
Connecteur Led Pad Avant RGBW T  
Conector Led Pad Avant RGBW T



529327

INC. 1ud

Extensión 0,5m 5 PIN DMX Led Pad Avant RGBW  
Extension 0,5m 5 PIN DMX Led Pad Avant RGBW  
Rallonge 0,5m 5 PIN DMX Led Pad Avant RGBW  
Extensão 0,5m 5 PINDMX Led Pad Avant RGBW



516020

INC. 1ud

Extensión 3m DMX Led Pad Avant RGBW  
Extension 3m DMX Led Pad Avant RGBW  
Rallonge 3m DMX Led Pad Avant RGBW  
Extensão 3m DMX Led Pad Avant RGBW



588911

Extensión fuente de alimentación 0,5m  
Power supply extension 0,5m  
Rallonge d'alimentation 0,5m  
Extensão da fonte de alimentação 0,5m



588928

INC. 1ud

Extensión fuente de alimentación 1m  
Power supply extension 1m  
Rallonge d'alimentation 1m  
Extensão da fonte de alimentação 1m



391535

INC. 1ud

Extensión fuente de alimentación 3m  
Power supply extension 3m  
Rallonge d'alimentation 3m  
Extensão da fonte de alimentação 3m



588942

INC. 1ud

Extensión fuente de alimentación 5m  
Power supply extension 5m  
Rallonge d'alimentation 5m  
Extensão da fonte de alimentação 5m



488447

INC. 1ud

Fuente alimentación 60W 24V con conector (alimenta 2 Led Pad)  
Power supply 60W 24V with connector (powers 2 Led Pad)  
Alimentation 60W 24V avec connecteur (alimente 2 Led Pad)  
Fonte de alimentação 60W 24V com conector (alimenta 2 Led Pad)



488464

INC. 1ud

Fuente alimentación 100W 24V con conector (alimenta 3 Led Pad)  
Power supply 100W 24V with connector (powers 3 Led Pad)  
Alimentation 100W 24V avec connecteur (alimente 3 Led Pad)  
Fonte de alimentação 100W 24V com conector (alimenta 3 Led Pad)



481687

INC. 1ud

Fuente alimentación 150W 24V con conector (alimenta 5 Led Pad)  
Power supply 150W 24V with connector (powers 5 Led Pad)  
Alimentation 150W 24V avec connecteur (alimente 5 Led Pad)  
Fonte de alimentação 150W 24V com conector (alimenta 5 Led Pad)



481694

INC. 1ud

Fuente alimentación 200W 24V con conector (alimenta 7 Led Pad)  
Power supply 200W 24V with connector (powers 7 Led Pad)  
Alimentation 200W 24V avec connecteur (alimente 7 Led Pad)  
Fonte de alimentação 200W 24V com conector (alimenta 7 Led Pad)







# Realizaciones

Realizations

Réalisations

Realizações



Dip. de Pontevedra



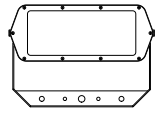

Hexagon Play RGBW







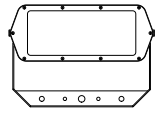

Hexagon Play RGBW

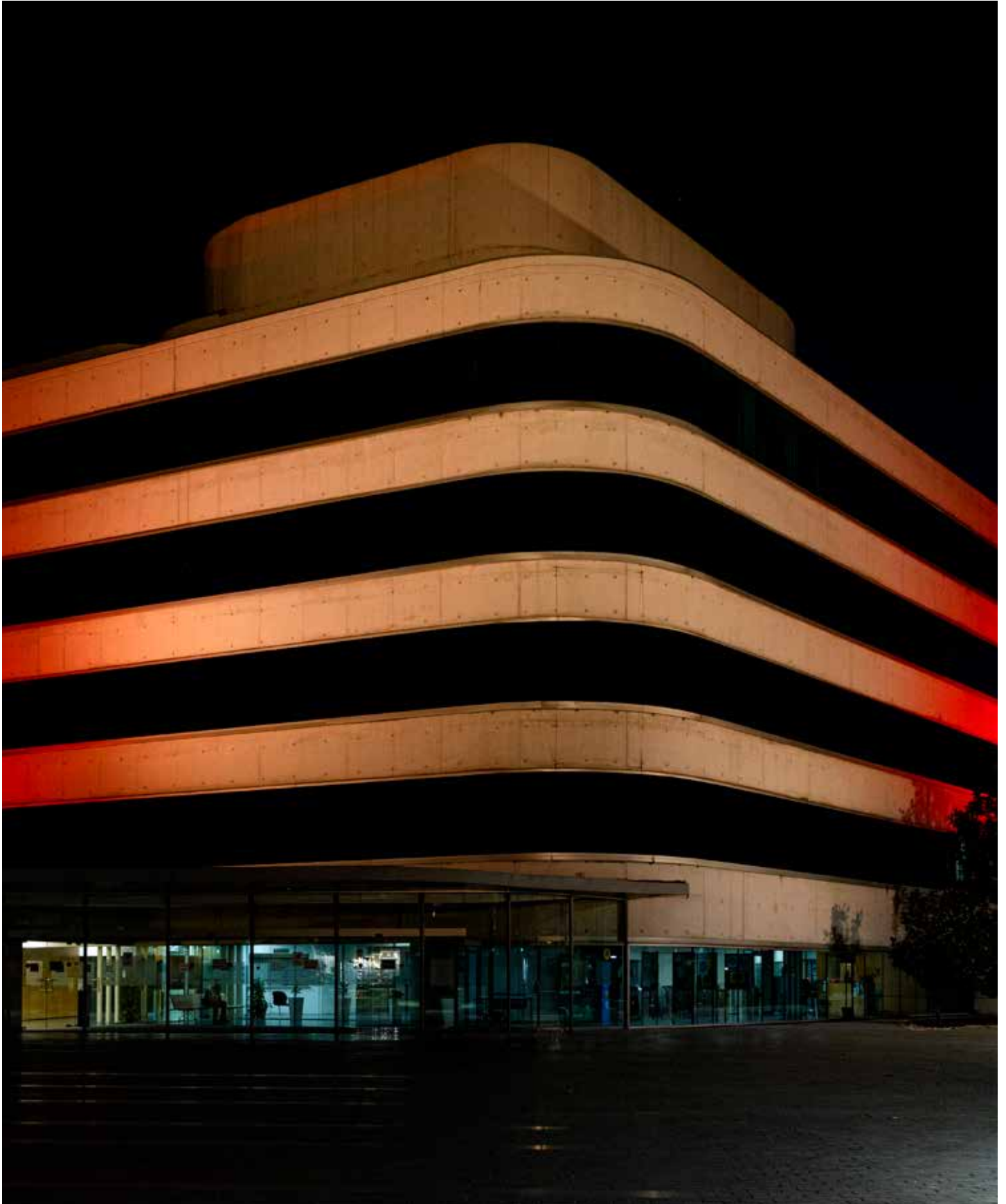



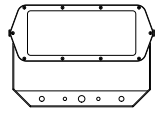

Hexagon Play RGBW









Proyecto de Iluminación  
Casa Botines  
León

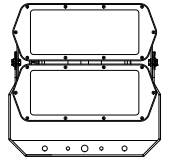

Hexagon Play RGBW

















Fotometría  
Photometry  
Photométrie  
Fotometria

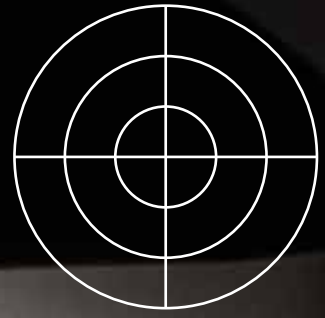

## Curva de distribución (CDL)

Light distribution curve (LDC)

Courbe de répartition de la lumière (CRL)

Luz curva de distribuição (LCD)

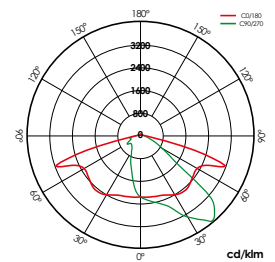
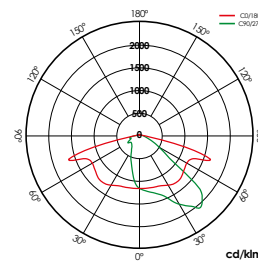
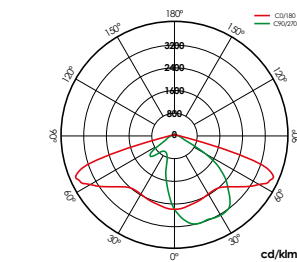
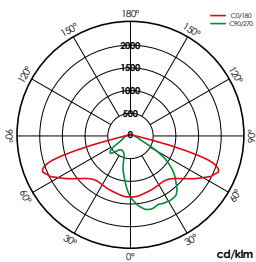
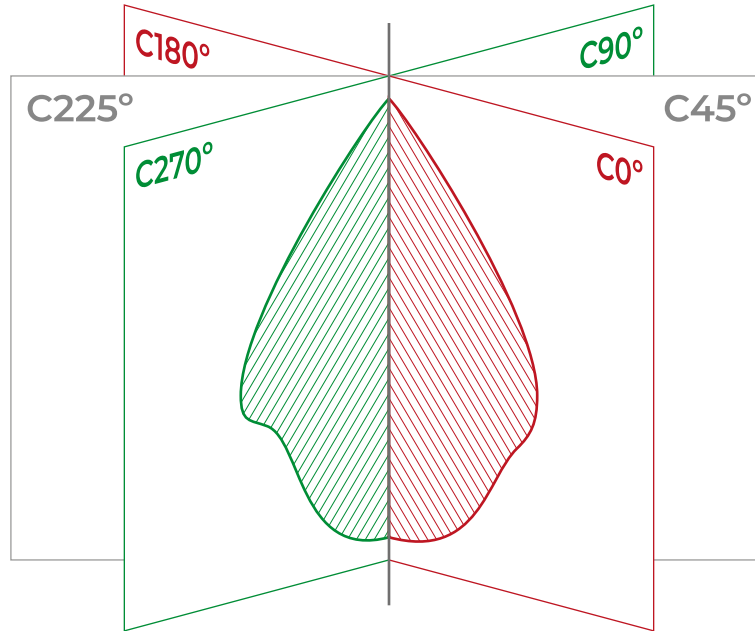

Representa la distribución de la luminosidad de las luminarias. Todas las luminarias que cuentan con una CDL han sido medidas en un sistema de medición o fotogoniómetro. Habitualmente el espacio entorno a la luminaria está dividido en planos C, como puede verse en el dibujo. Los planos más utilizados para la representación son el plano C0° - C180°, que corta a la lámpara transversalmente, y el plano C90° - C270°, que lo hace de manera longitudinal.

La CDL se representa en un gráfico 2D en el que se superponen normalmente estos 2 planos. El plano C0° - C180° dibujado con una línea continua y el plano C90° - C270° dibujado con una línea discontinua. En el caso de la derecha se trata de una luminaria axialmente simétrica directa. Y en la izquierda podemos ver una luminaria asimétrica.

Represents the distribution of the brightness of the lights. All luminaires which have a LDC have been measured in a measurement system or photogoniometer. Usually the space around the lamp is divided into levels C, as shown in the drawing. The most common planes for the representation are C0° - C180°, which cuts across the lamp, and C90° - C270° plane, which makes it but longitudinally.

The LDC is represented in a 2D graph that normally overlap these two planes. The C0° - C180° plane, drawn with a solid line and the C90° - C270° plane, drawn with a dashed line. For the right, it is axially symmetrical direct luminaire. And on the left, we can see an asymmetric luminaire.

Représente la répartition de la luminosité de la luminaire. Tous les luminaires ont une CRL ont été mesurés dans un système de mesure ou photogoniomètre. Habituellement, l'espace autour de la lampe est divisé en niveaux C, comme représenté sur le dessin. Les plans les plus couramment utilisés pour représenter sont à plan C0° - C180°, qui traverse la lampe et le plan C90° - C270°, ce qui le fait longitudinalement.

Le CRL est représenté dans un graphique 2D qui se chevauchent normalement en ces deux plans. Le plan C0° - C180° dessinés avec une ligne solide et le plan C90° - C270° dessinés avec une ligne pointillée. A la droite, c'est un luminaire axialement directe symétrique. Et a la gauche, nous pouvons voir un luminaire asymétrique.

Representa a distribuição do brilho das luzes. Todas as luminárias têm um CDL foram medidos em um sistema de medição ou fotogoniómetro. Normalmente, o espaço à volta da lâmpada está dividido em níveis C, como mostrado no desenho. Os planos mais usados para representar são planos C0° - C180°, que corta através da lâmpada, e planos C90° - C270°, que o faz longitudinalmente.

A LCD é representado em um gráfico 2D que normalmente se sobrepõem estes dois planos. O plano C0° - C180° desenhado com uma linha sólida e o plano C90° - C270° desenhado com uma linha tracejada. A direita, é uma luminária axial direta simétrico. A esquerda, podemos ver uma luminária assimétrica.

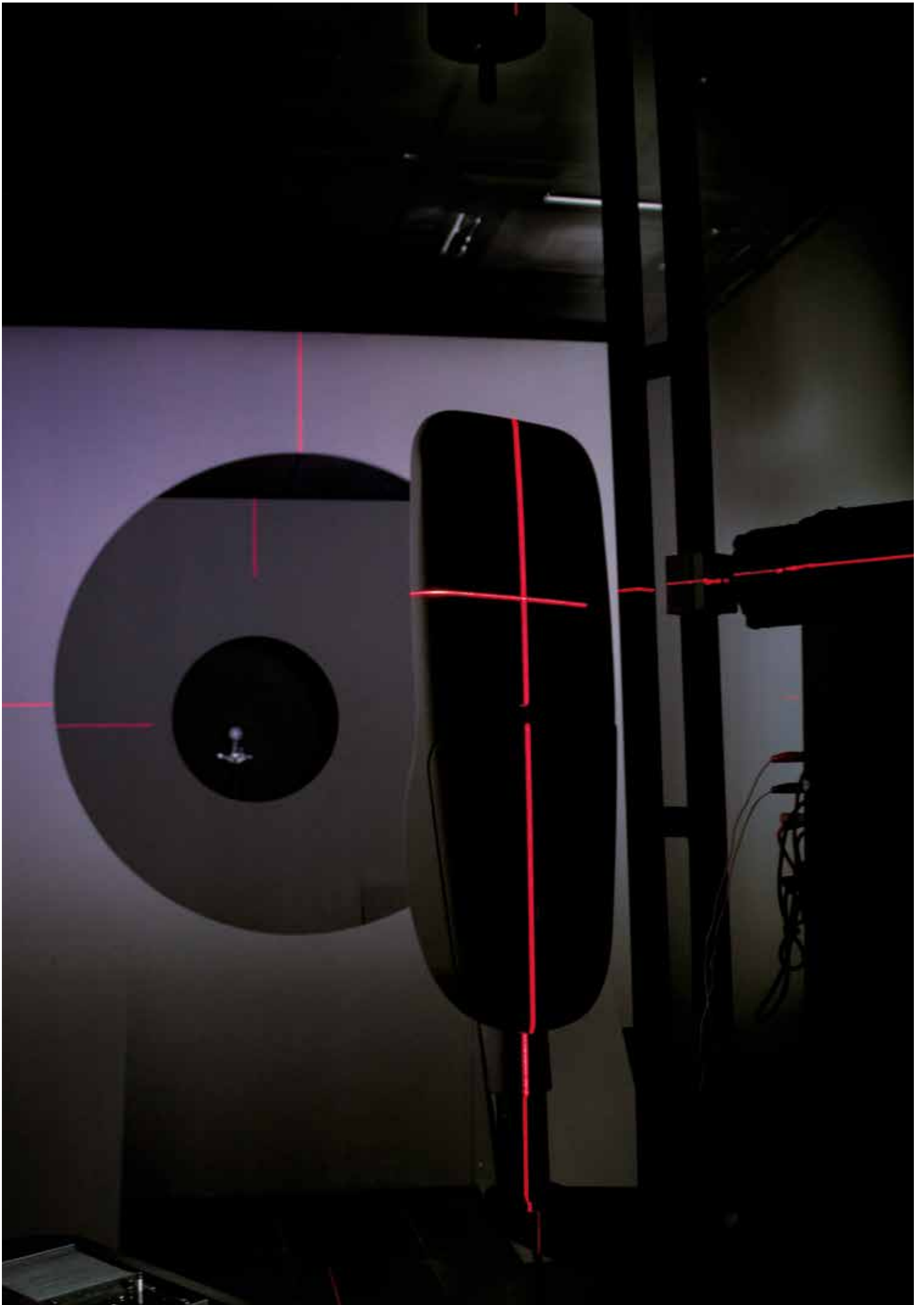



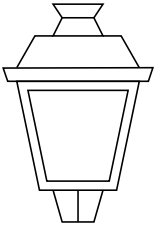

city

Arisa Road - Arisa Catenaria - Versa - Avatar - Veria

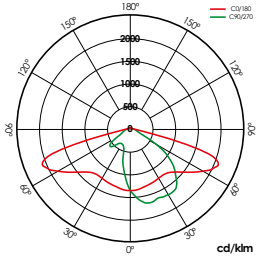

VA00KOM 12Led

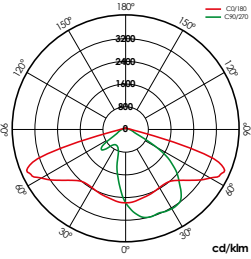

VA00KOM 24Led

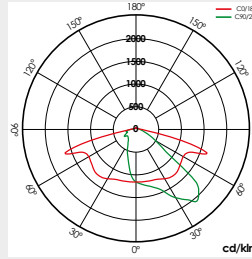

VA00LOM 12Led

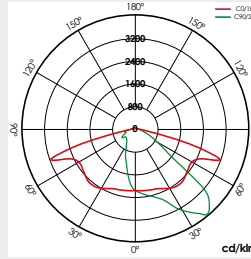

VA00LOM 24Led

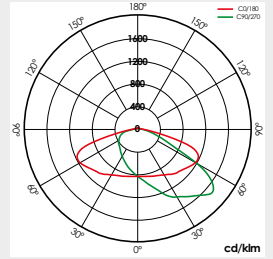

VA00IOP 12Led

Arisa Road - Arisa Catenaria - Versa - Avatar - Veria

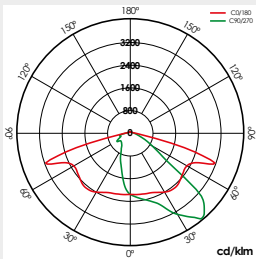

VA00IOP 24Led

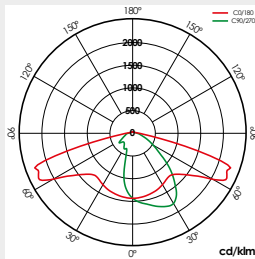

VA02LOM 12Led

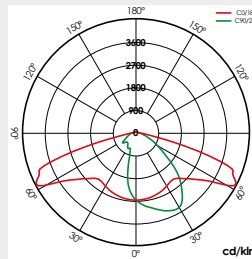

VA02LOM 24Led

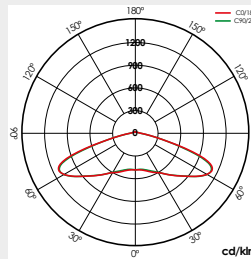

S150LOM 12Led

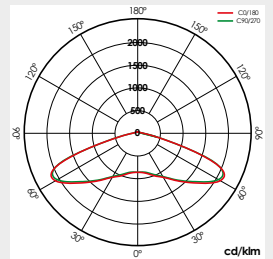

S150LOM 24Led

Arisa Road - Arisa Catenaria - Versa - Avatar - Veria

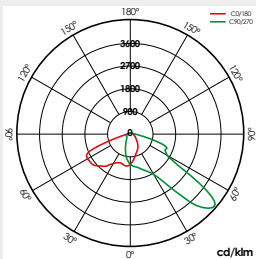

PPILOM 12Led

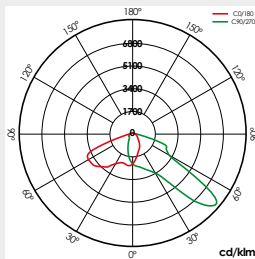

PPILOM 24Led

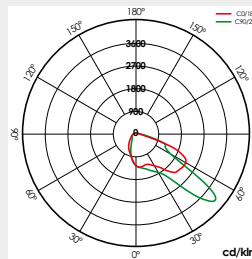

PPDLOM 12Led

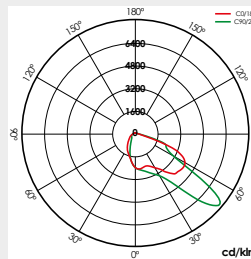

PPDLOM 24Led

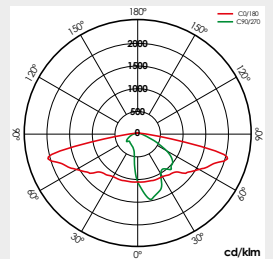

VA01LOM 12Led

Arisa Road - Arisa Catenaria - Versa - Avatar - Veria

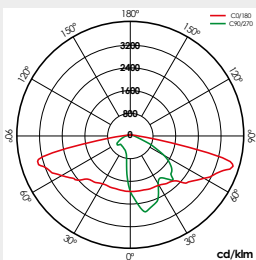

VA01LOM 24Led

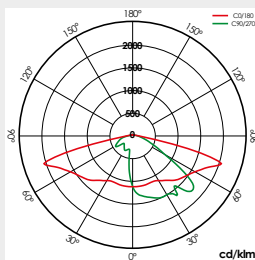

VA03DOP 12Led

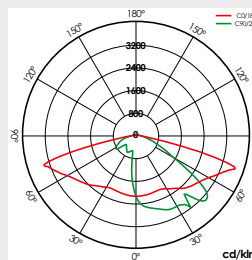

VA03DOP 24Led

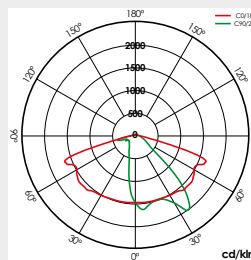

VA04DOP 12Led

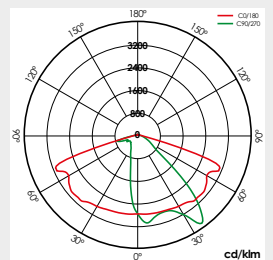

VA04DOP 24Led

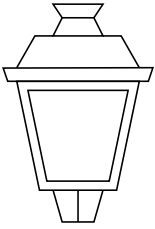

city

Arisa Road - Arisa Catenaria - Versa - Avatar - Veria

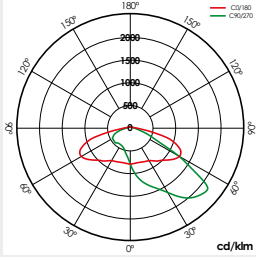

VA0510P 12Led

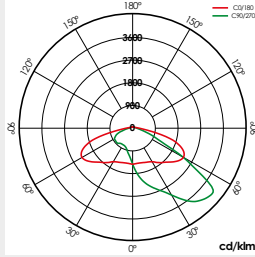

VA0510P 24Led

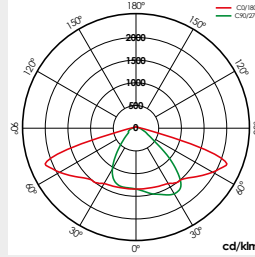

VA0610P 12Led

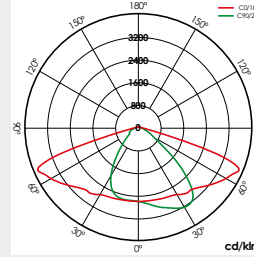

VA0610P 24Led

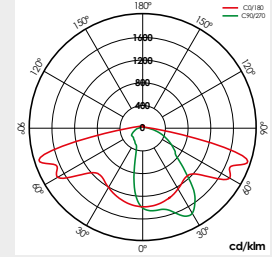

VA07L0P 12Led

Arisa Road - Arisa Catenaria - Versa - Avatar - Veria

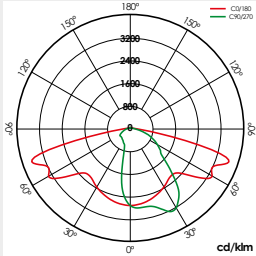

VA07L0P 24Led

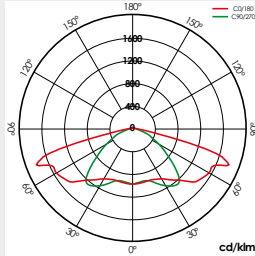

VA08L0M 12Led

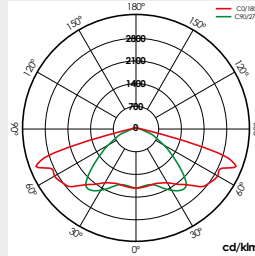

VA08L0M 24Led

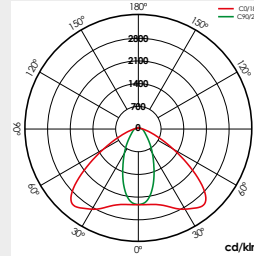

PEXL0M 12Led

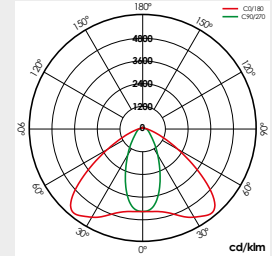

PEXL0M 24Led

Versa L - Avatar L

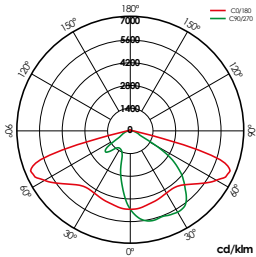

VA00K0M (≤900mA)

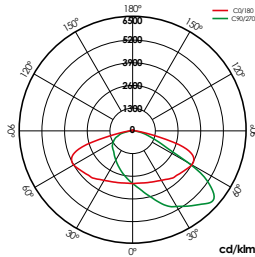

VA00I0P (1000mA)

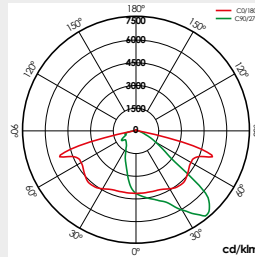

VA00L0M (≤900mA)

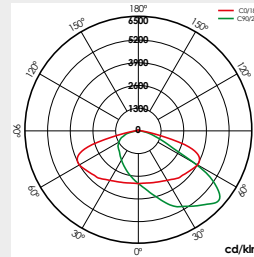

VA00I0P (≤900mA)

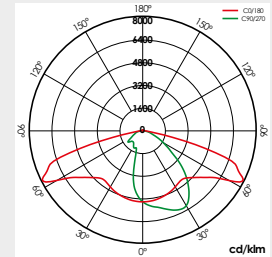

VA02L0M (≤900mA)

Versa L - Avatar L

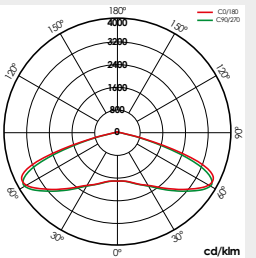

S150L0M (≤900mA)

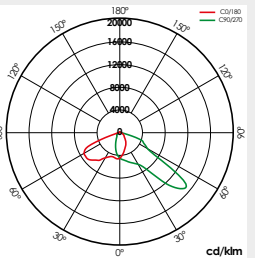

PPILOM (≤900mA)

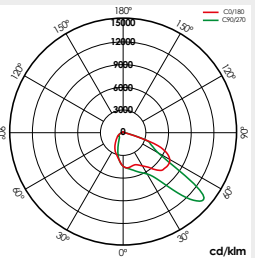

PPDLOM (≤900mA)

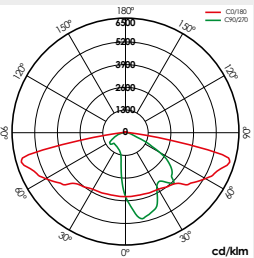

VA01L0M (≤900mA)

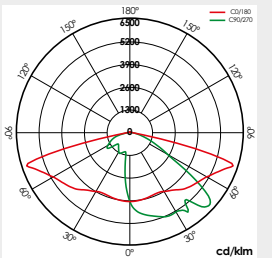

VA03D0P



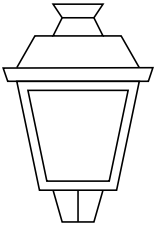

city

Versa XL

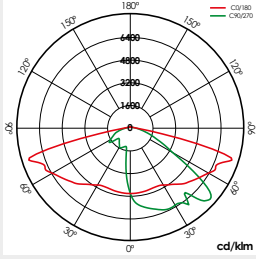

VA03D0P 64Led

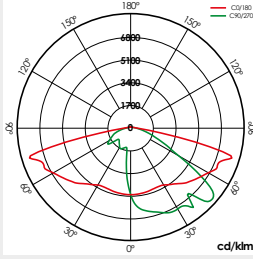

VA03D0P 80Led

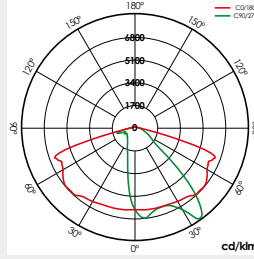

VA04D0P 64Led

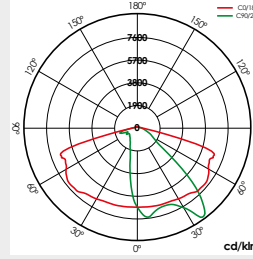

VA04D0P 80Led

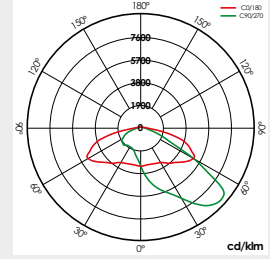

VA05I0P 64Led

Versa XL

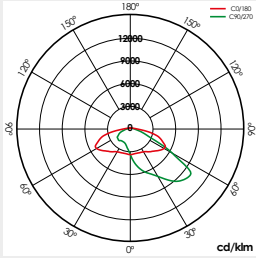

VA05I0P 80Led

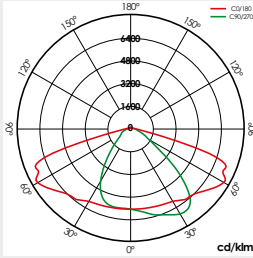

VA06I0P 64Led

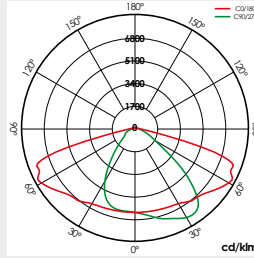

VA06I0P 80Led

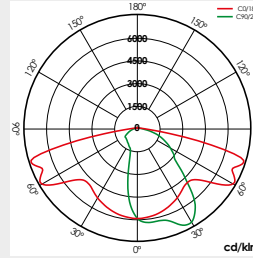

VA07L0P 64Led

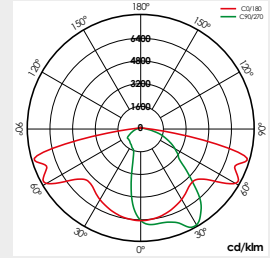

VA07L0P 80Led

Versa XL

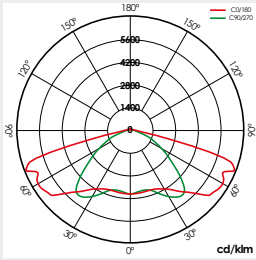

VA08L0M (≤800mA)  
64Led

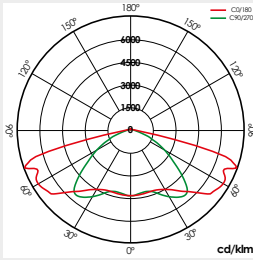

VA08L0M (≤700mA)  
80Led

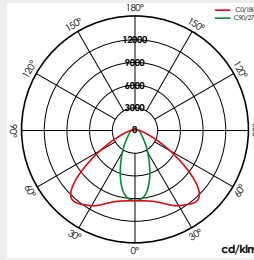

PEXL0M (≤800mA)  
64Led

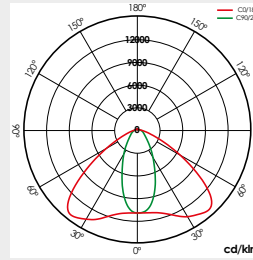

PEXL0M (≤700mA)  
80Led

Avatar XL

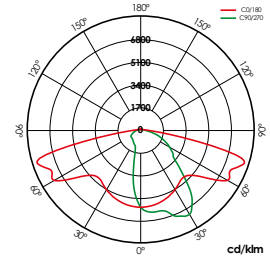

VA00K0M (≤800mA)

Avatar XL

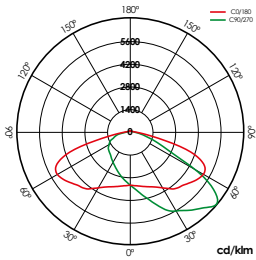

VA00I0P (900 - 1000mA)

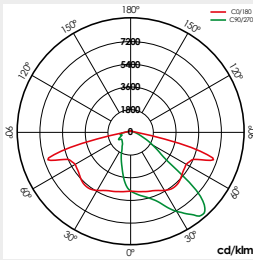

VA00L0M (≤800mA)

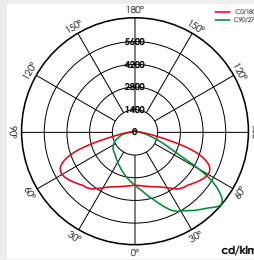

VA00I0P (≤800mA)

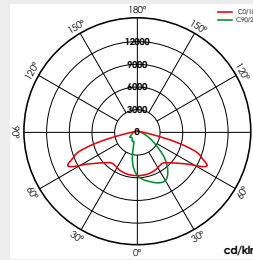

VA02L0M (≤800mA)

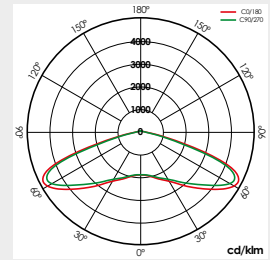

S150L0M (≤800mA)





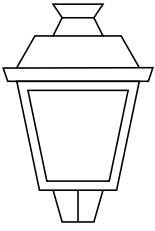

city

Arisa Top 1

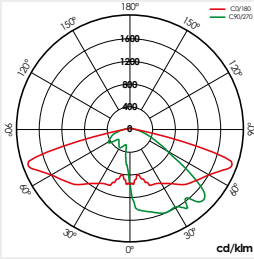

VA03D0P 12Led

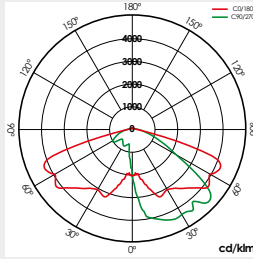

VA03D0P 32Led

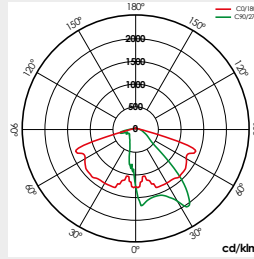

VA04D0P 12Led

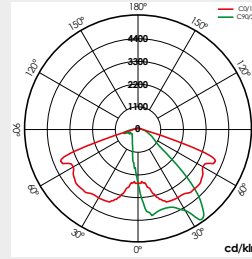

VA04D0P 32Led

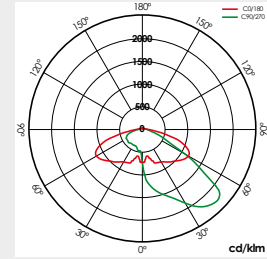

VA05I0P 12Led

Arisa Top 1

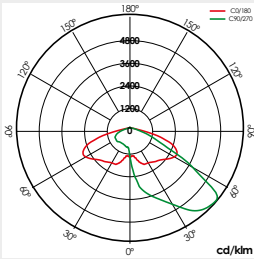

VA05I0P 32Led

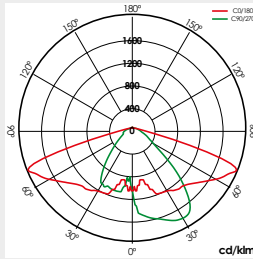

VA06I0P 12Led

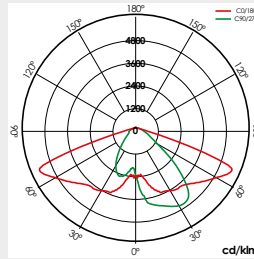

VA06I0P 32Led

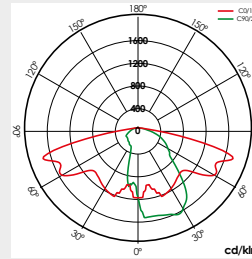

VA07L0P 12Led

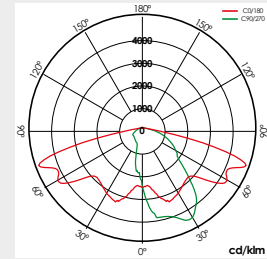

VA07L0P 32Led

Arisa Top 1

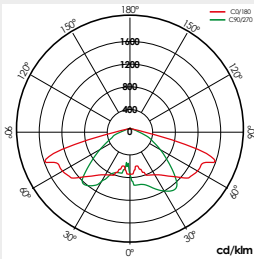

VA08L0M 12Led

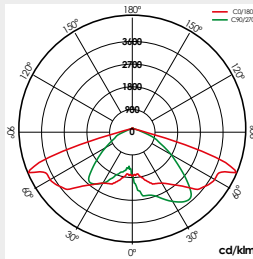

VA08L0M 32Led

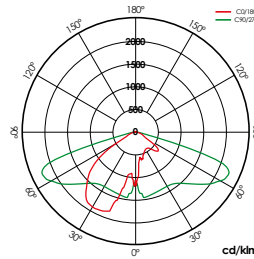

VA00K0M 12Led

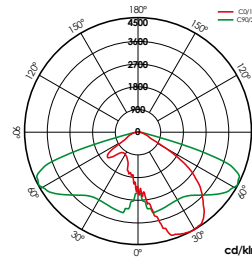

VA00K0M 32Led

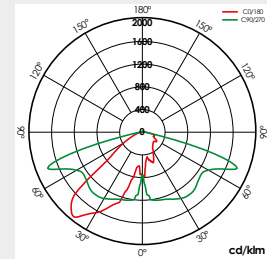

VA00L0M 12Led

Arisa Top 2

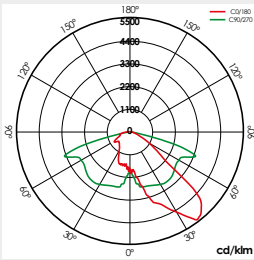

VA00L0M 32Led

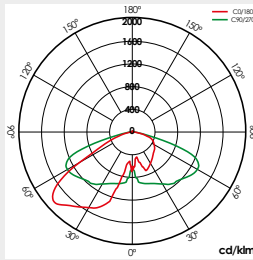

VA00I0P 12Led

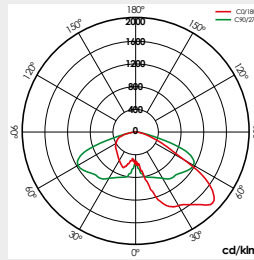

VA00I0P 32Led

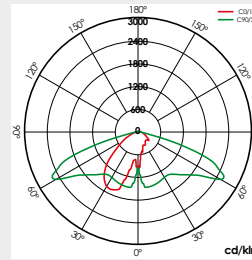

VA02L0M 12Led

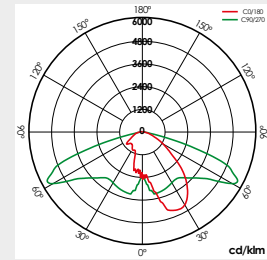

VA02L0M 32Led

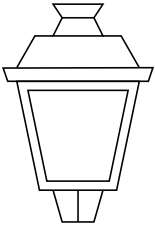

city

Arisa Top 2

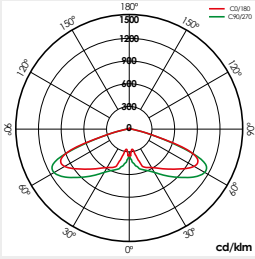

S150L0M 12Led

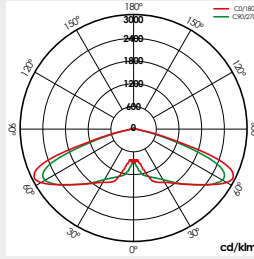

S150L0M 32Led

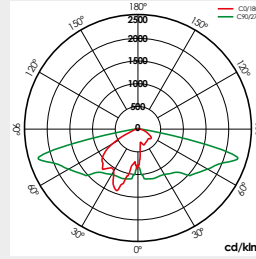

VA01L0M 12Led

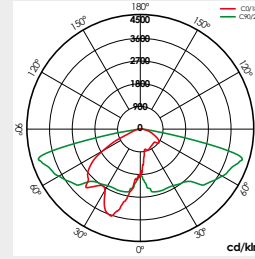

VA01L0M 32Led

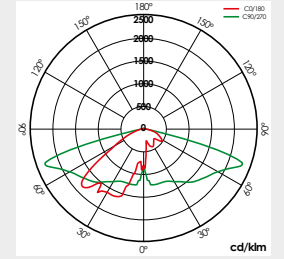

VA03D0P 12Led

Arisa Top 2

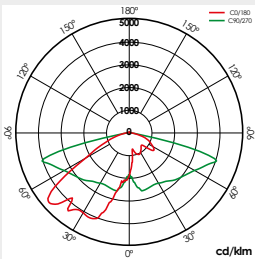

VA03D0P 32Led

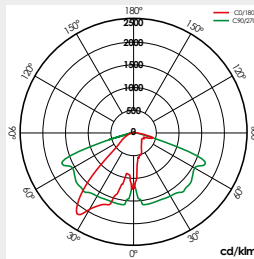

VA04D0P 12Led

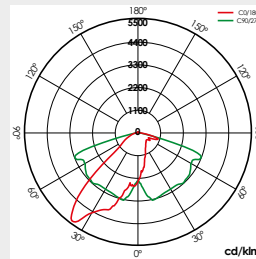

VA04D0P 32Led

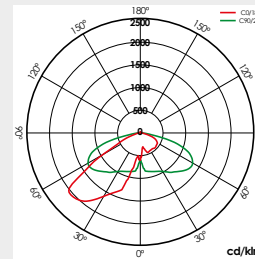

VA05I0P 12Led

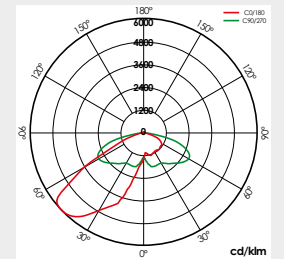

VA05I0P 32Led

Arisa Top 2

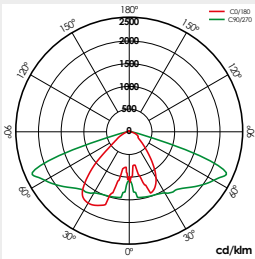

VA06I0P 12Led

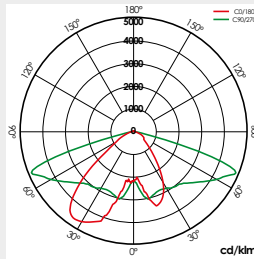

VA06I0P 32Led

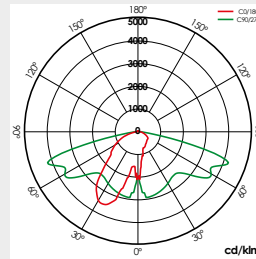

VA07L0P 12Led

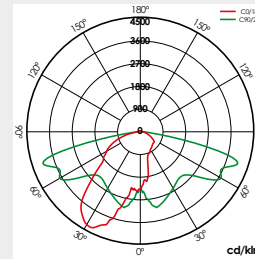

VA07L0P 32Led

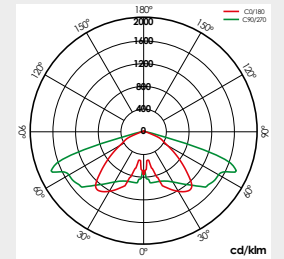

VA08L0M 12Led

Arisa Top 2

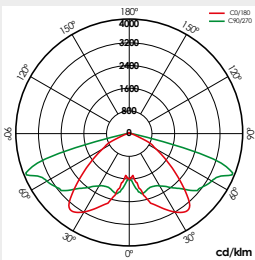

VA08L0M 32Led

Arisa Top 4

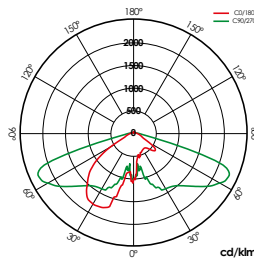

VA00K0M 12Led

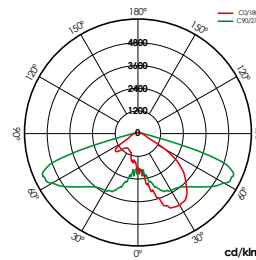

VA00K0M 32Led

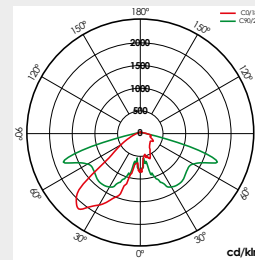

VA00L0M 12Led

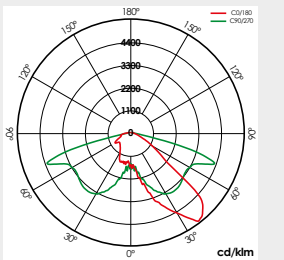

VA00L0M 32Led

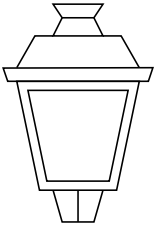

city

Arisa Top 4

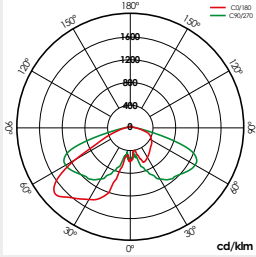

VA0010P 12Led

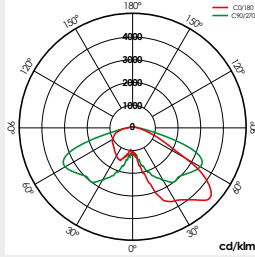

VA0010P 32Led

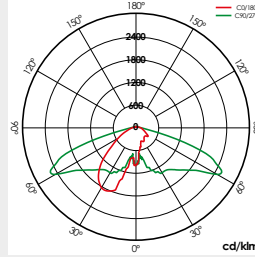

VA02L0M 12Led

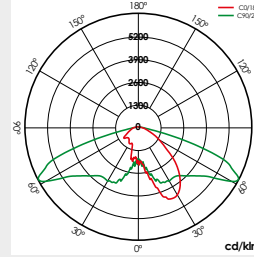

VA02L0M 32Led

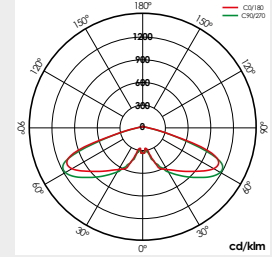

S150L0M 12Led

Arisa Top 4

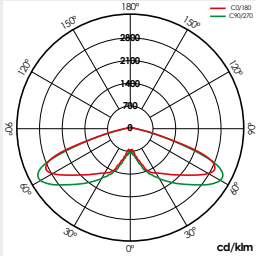

S150L0M 32Led

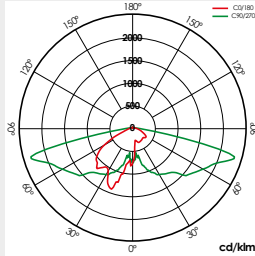

VA01L0M 12Led

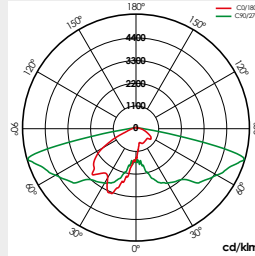

VA01L0M 32Led

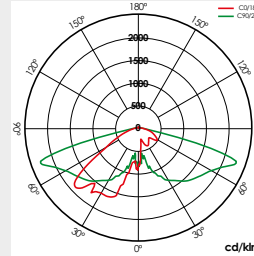

VA03D0P 12Led

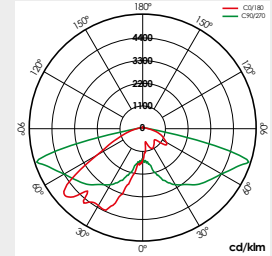

VA03D0P 32Led

Arisa Top 4

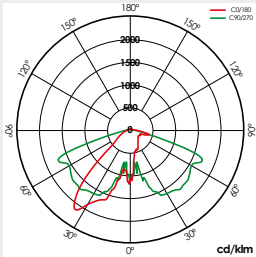

VA04D0P 12Led

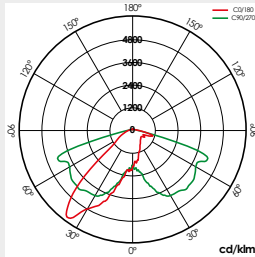

VA04D0P 32Led

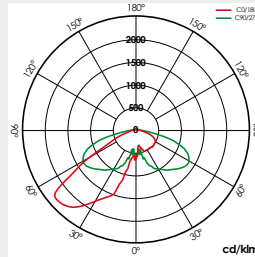

VA05I0P 12Led

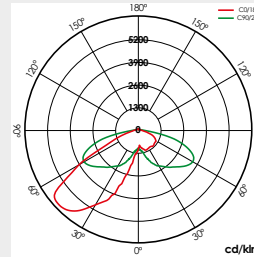

VA05I0P 32Led

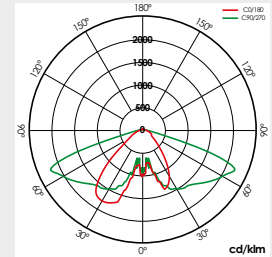

VA06I0P 12Led

Arisa Top 4

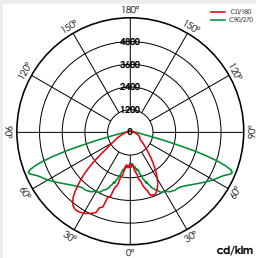

VA06I0P 32Led

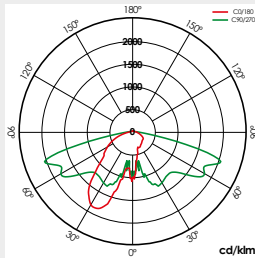

VA07L0P 12Led

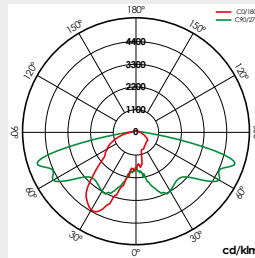

VA07L0P 32Led

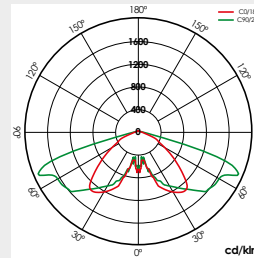

VA08L0M 12Led

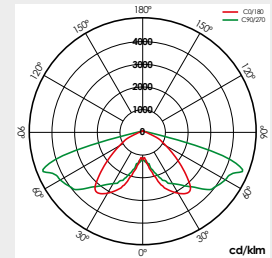

VA08L0M 32Led



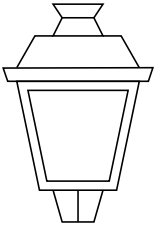

city

Netta

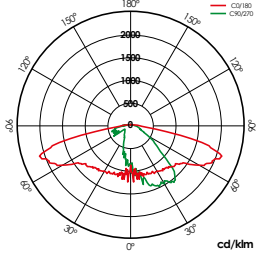

VA00LIM 12Led

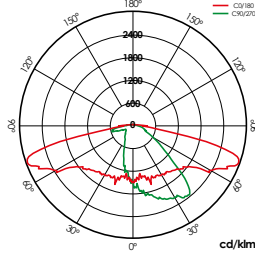

VA00LIM 24Led

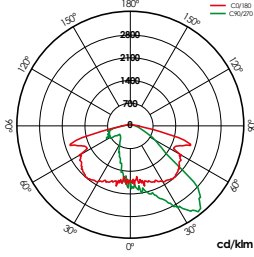

VA00K0M 32Led

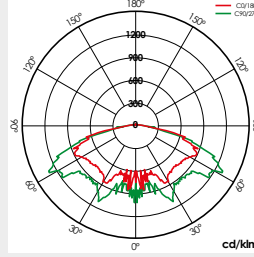

S150LIM 12Led

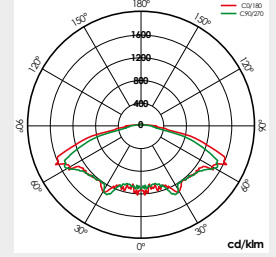

S150LIM 24Led

Netta

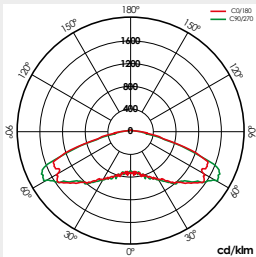

S150LOM 32Led

Livia

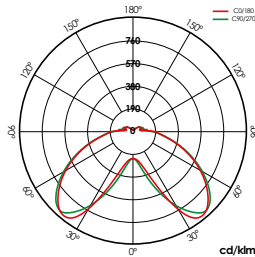

S150LIM

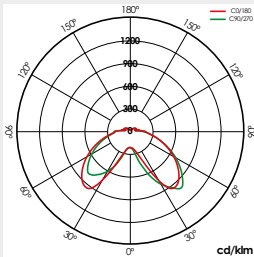

VA00LIM

Ircana

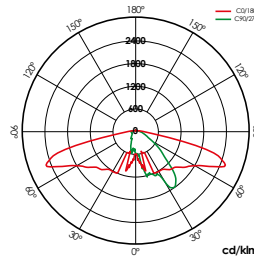

VA00LIP 12Led

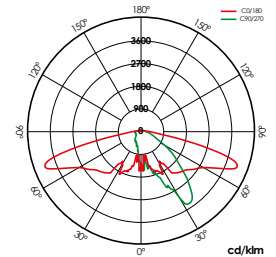

VA00LIP 24Led

Ircana

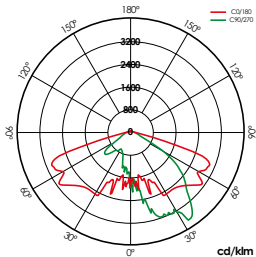

VA00K0M 32Led

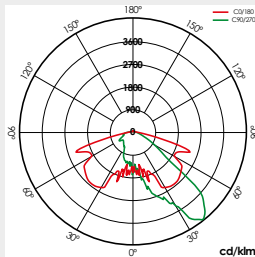

VA00LOM 32Led

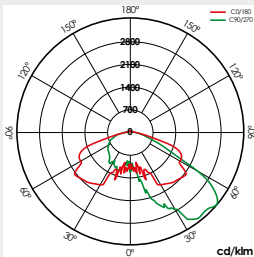

VA00I0P 32Led

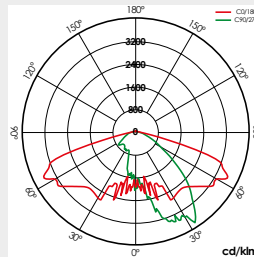

VA02LOM 32Led

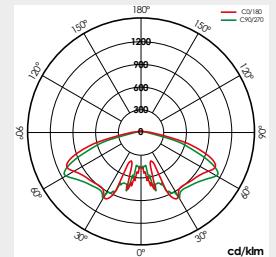

S150IIP 12Led

Ircana

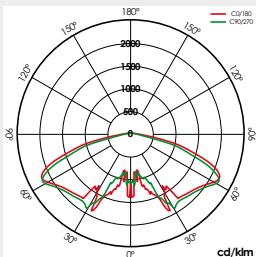

S150IIP 24Led

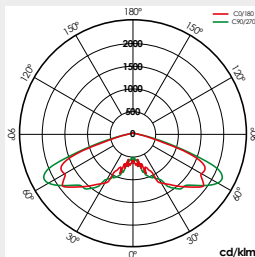

S150LOM 32Led

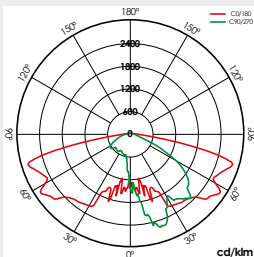

VA01LOM 32Led

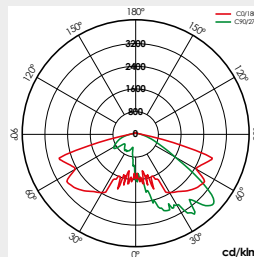

VA03D0P 32Led

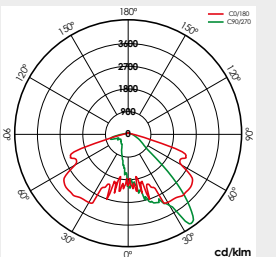

VA04D0P 32Led

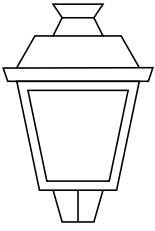

# city

## Ircana

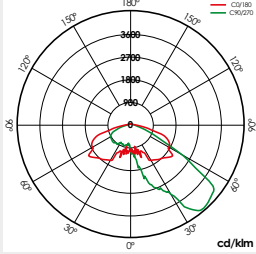

VA05I0P 32Led

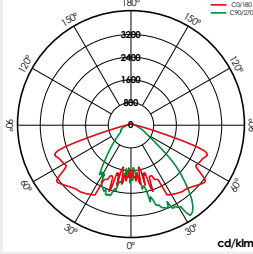

VA06I0P 32Led

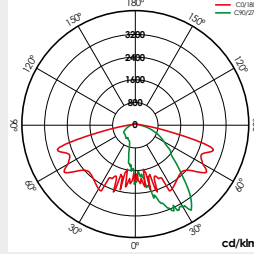

VA07L0P 32Led

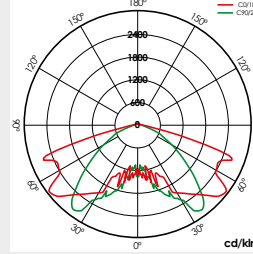

V08L0M 32Led

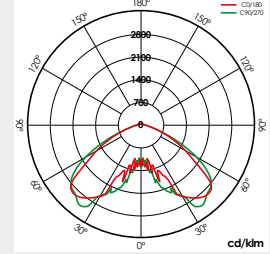

S138L0M 32Led

## Gaudium

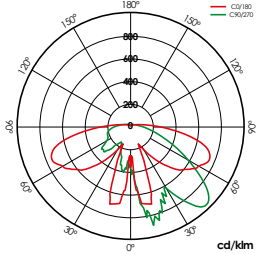

VA00L1P 12Led

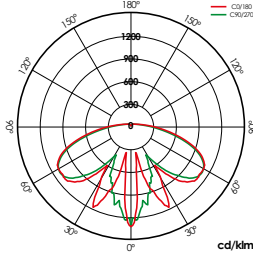

VA00L1P 24Led

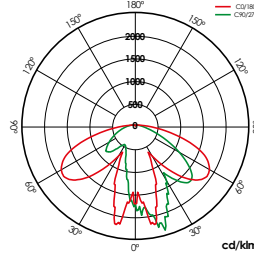

VA00K0M 32Led

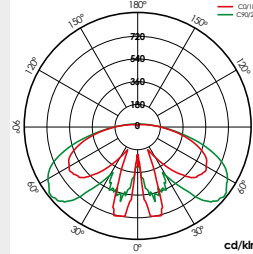

S150I1P 12Led

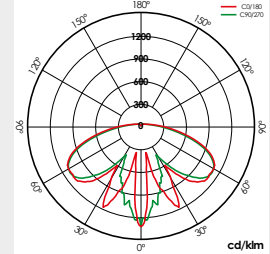

S150I1P 24Led

## Gaudium

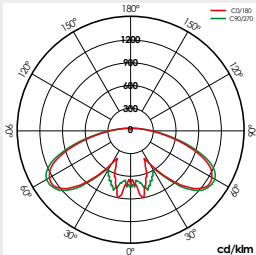

S150L0M 32Led

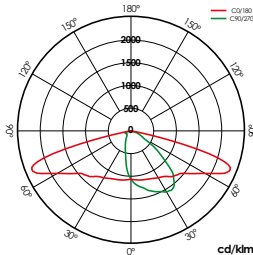

VA00L1P 12Led

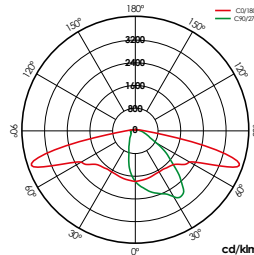

VA00L1P 24Led

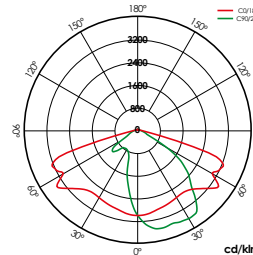

VA00K0M 32Led

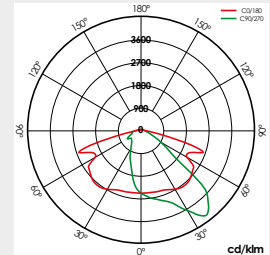

VA00L0M 32Led

## Grupo óptico Universal

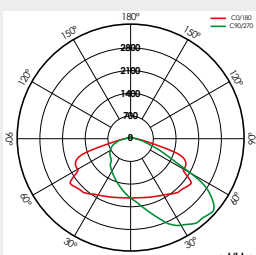

VA00I0P 32Led

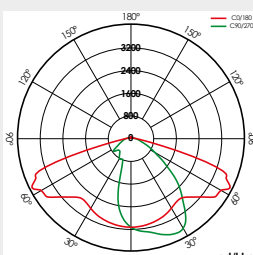

VA02L0M 32Led

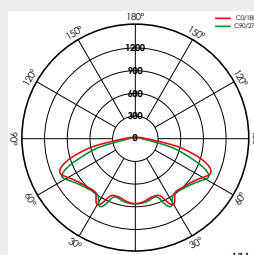

S150I1P 12Led

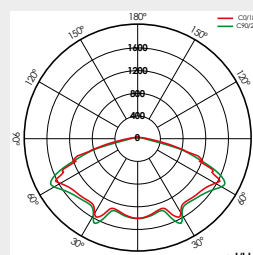

S150I1P 24Led

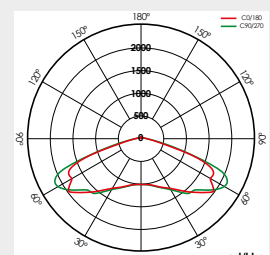

S150L0M 32Led

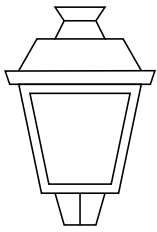

# city

## Grupo Óptico Universal

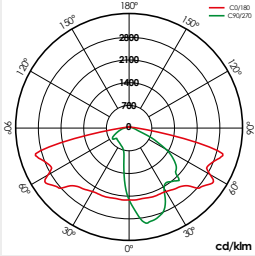

VA01L0M 32Led

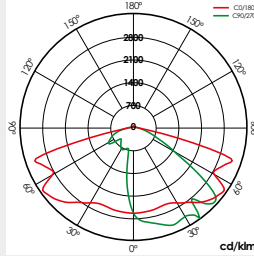

VA03D0P 32Led

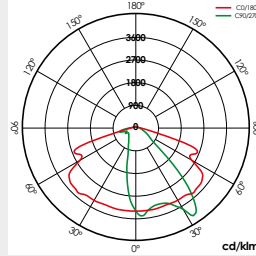

VA04D0P 32Led

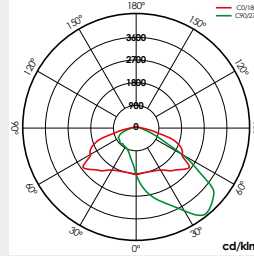

VA05I0P 32Led

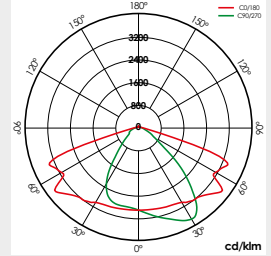

VA06I0P 32Led

## Grupo Óptico Universal

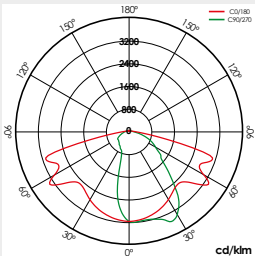

VA07L0P 32Led

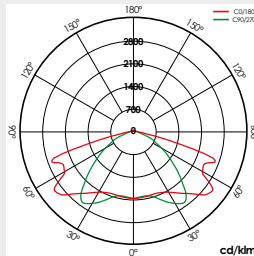

V08L0M 32Led

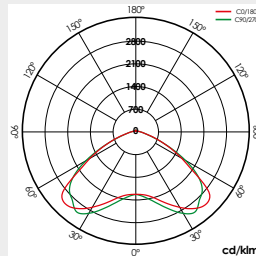

S138L0M 32Led

## Zereus Switch

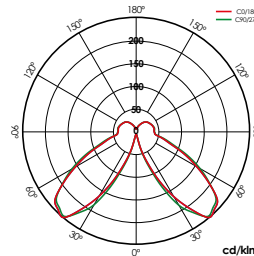

25W

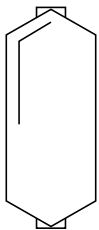

# Industrial

## Hexagon Zenit 48 Leds

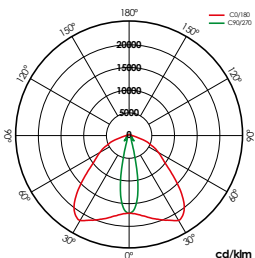

PEXL0M

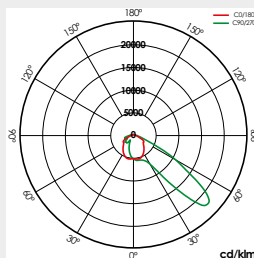

AINL0M

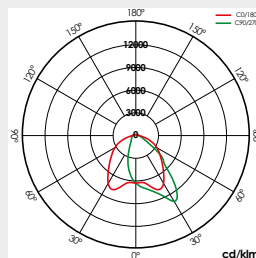

AEXL0M

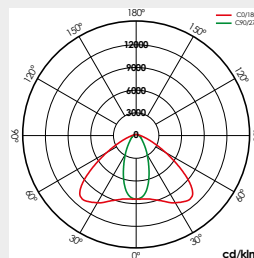

PINL0M

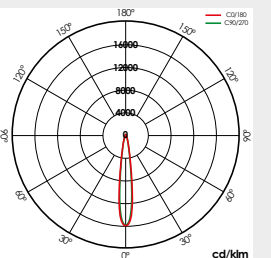

SOIGL0M

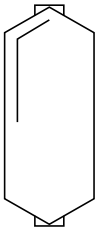

# Industrial

Hexagon Zenit 48 LedS

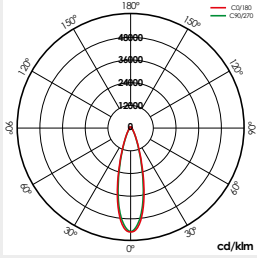

S028L0M

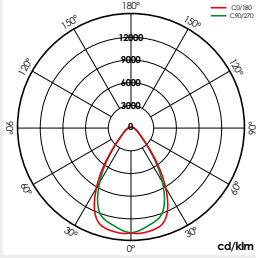

S068L0M

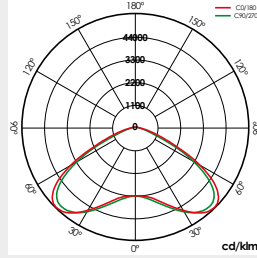

S134L0M

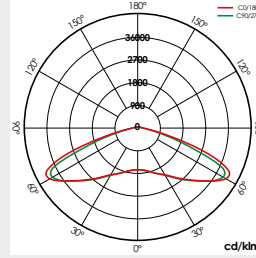

S152L0M

Hexagon Zenit 144 LedS

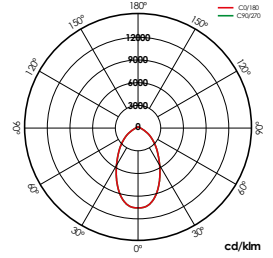

S060L0P

Hexagon Zenit 144 LedS

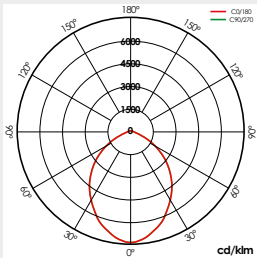

S090L0P

Berlín Avant

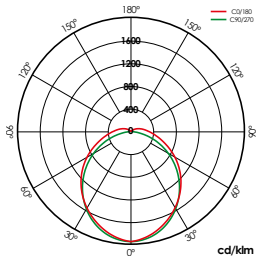

1.200mm

Benzine

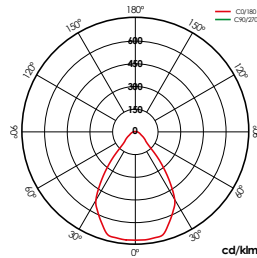

Empotrar S069L0P  
Embed S069L0P  
Empotrate S069L0P  
Empotrate S069L0P

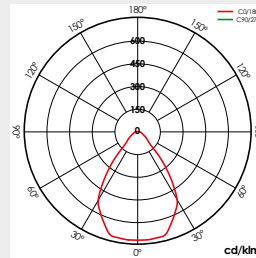

Superficie S069L0P  
Surface S069L0P  
Surface S069L0P  
Superficie S069L0P

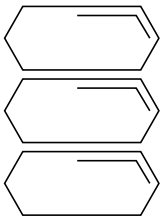

# Projection

Hexagon Play Essential

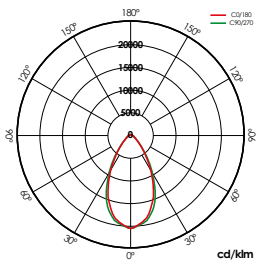

S055I2P

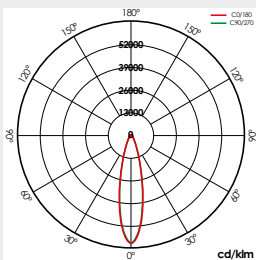

S025I2P

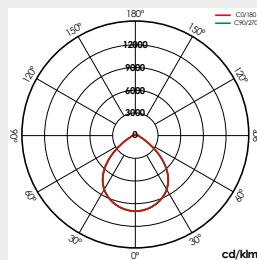

S090I2P

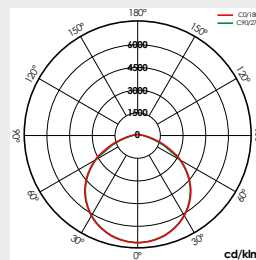

SIN LENTE

Hexagon Play Óptima

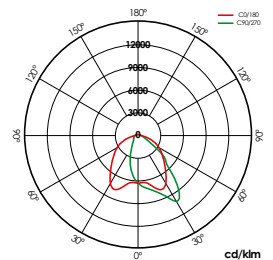

AEXL0M 1X/2X



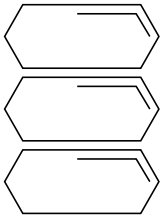

# Projection

## Hexagon Play Óptima

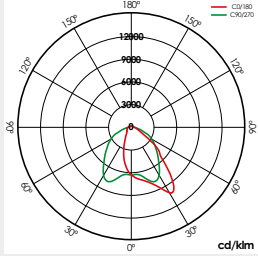

AEXLOM 3X/ 4X/ 5X

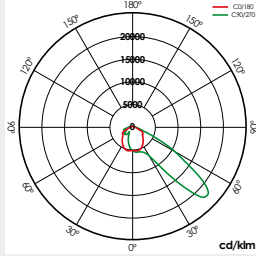

AINLOM 1X/ 2X

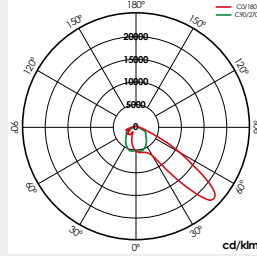

AINLOM 3X/ 4X/ 5X

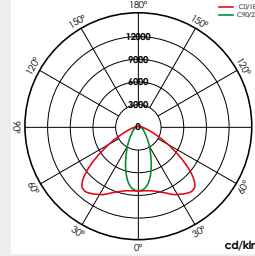

PINLOM 1X/ 2X

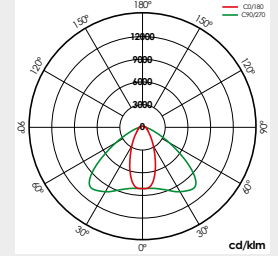

PINLOM 3X/ 4X/ 5X

## Hexagon Play Óptima

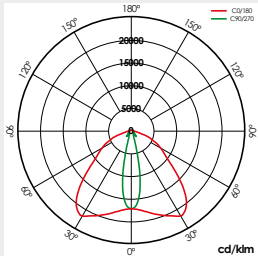

PEXLOM 1X/ 2X

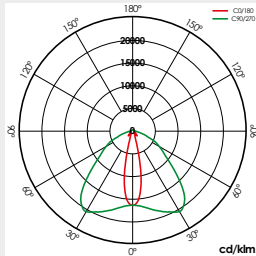

PEXLOM 3X/ 4X/ 5X

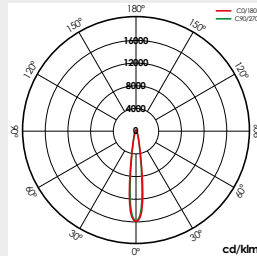

S016LOM

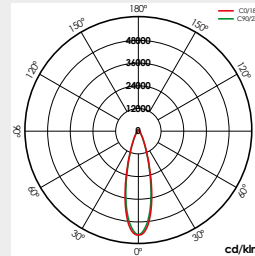

S028LOM

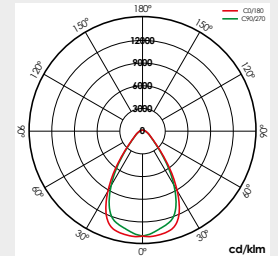

S068LOM

## Hexagon Play Óptima

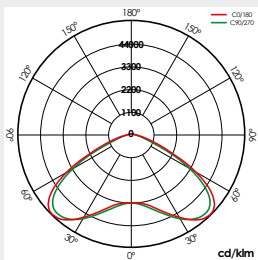

S134LOM

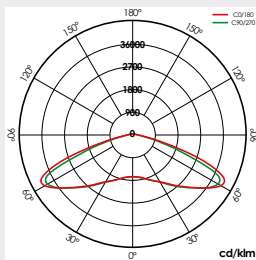

S152LOM

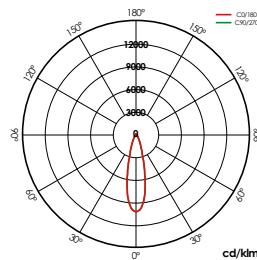

S033LOM

## Hexagon Play WAS

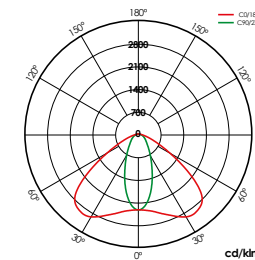

PEXLOM

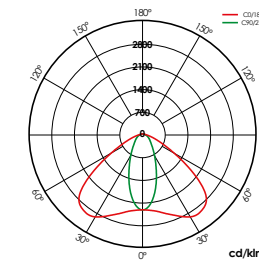

PINLOM

## Hexagon Play WAS

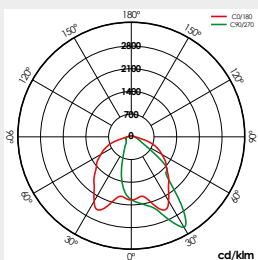

AEXLOM

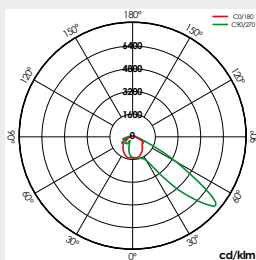

AINLOM

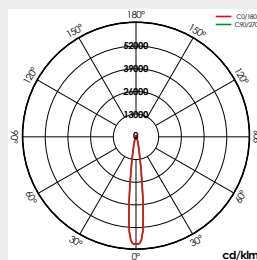

S014LOM

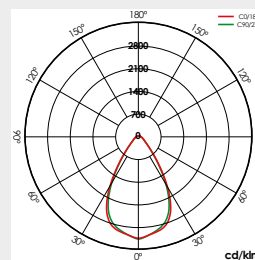

S069LOM

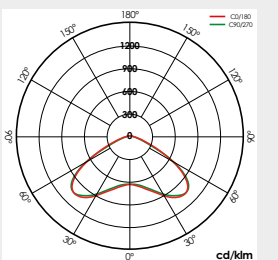

S138LOM

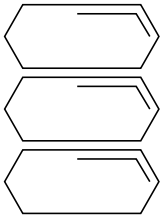

# Projection

Hexagon Play WAS

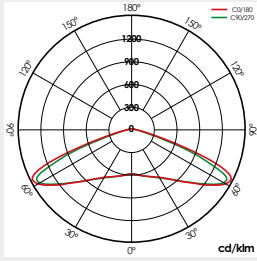

S150L0M

Hexagon Play Match Unity

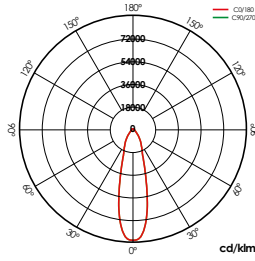

S030I2P

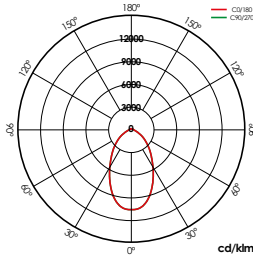

S060I2P

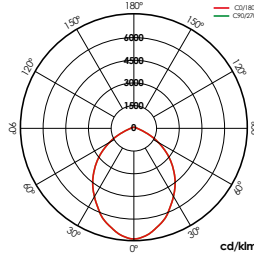

S090I2P

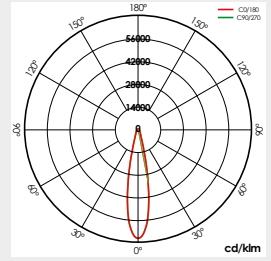

S020I2P

Hexagon Play Match

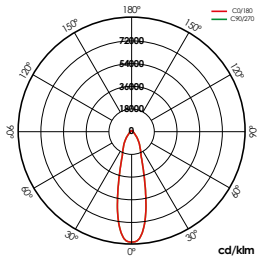

S030I2P

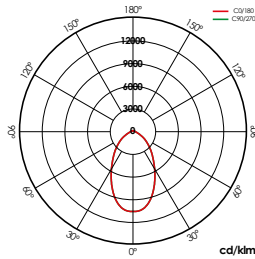

S060I2P

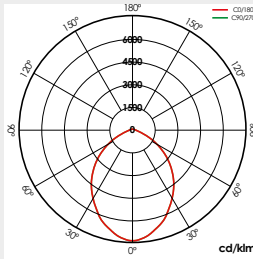

S090I2P

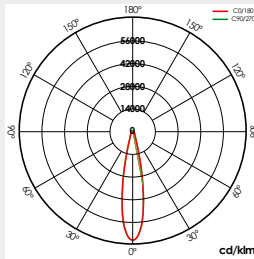

S020I2P

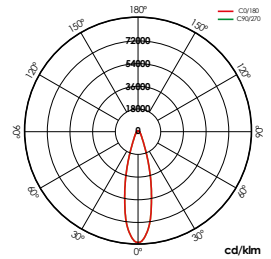

S026I2P

Hexagon Play Arena

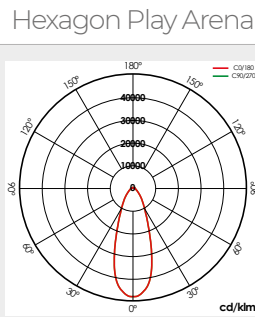

S037I2P

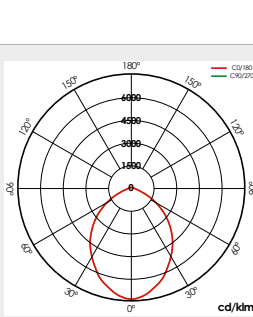

S090I2P

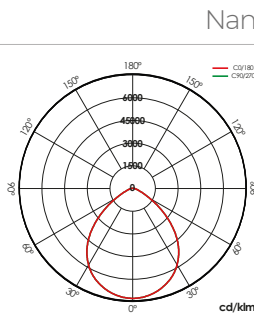

S090I2P

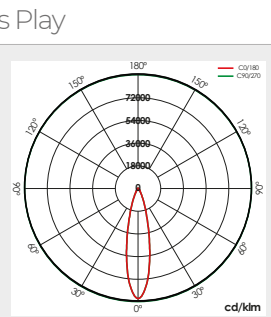

S025I2P

Hexagon Play Arena

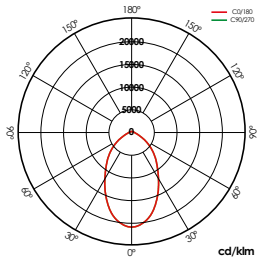

S066I2P

Nantes Play

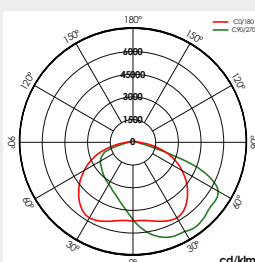

VA11I2P

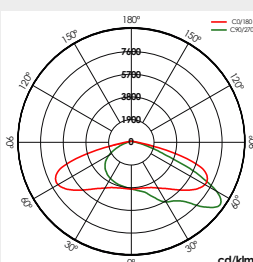

VA12I2P

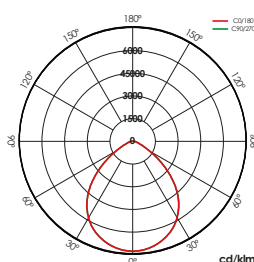

S090I2P

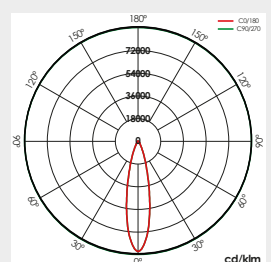

S025I2P

Nantes Play

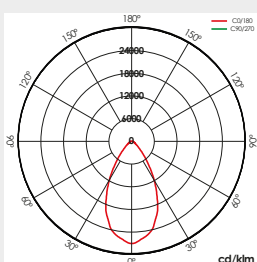

S055I2P

Nantes L Play

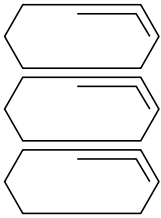

# Projection

Nantes L Play

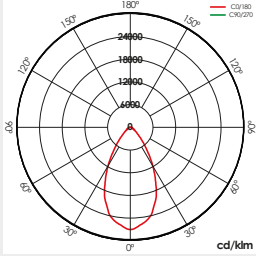

S055I2P

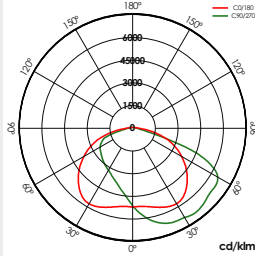

VA11I2P

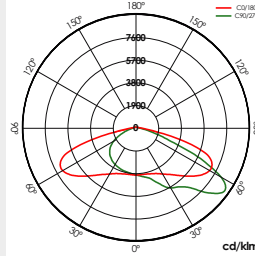

VA12I2P

Nantes XL Play

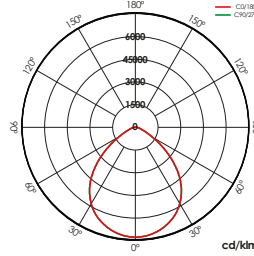

S090I2P

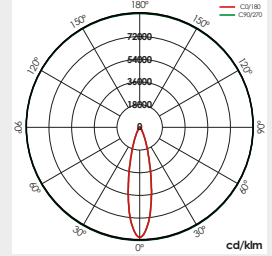

S025I2P

Nantes XL Play

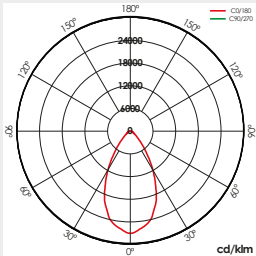

S055I2P

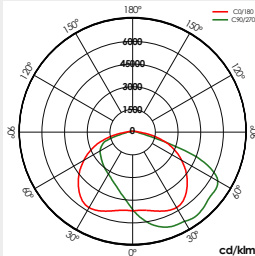

VA11I2P

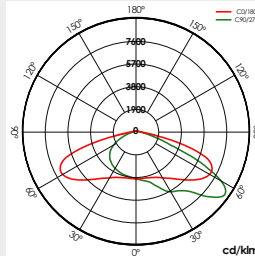

VA12I2P

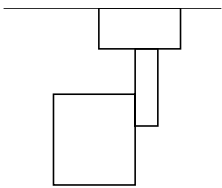

# Spaces

Lynx Led

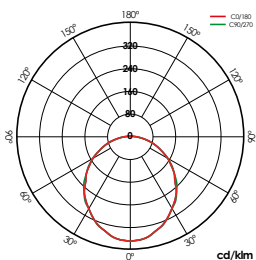

PC Opal

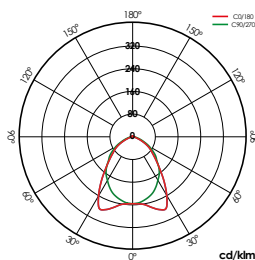

AL Especular

Lynx Led Line

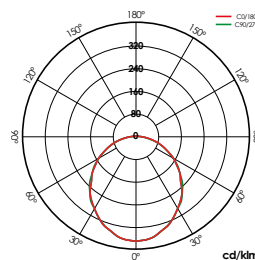

PC Opal

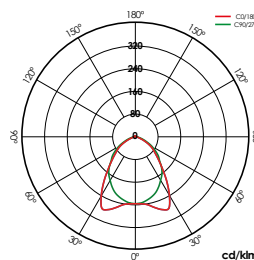

AL Especular

Lynx Led Empotrar

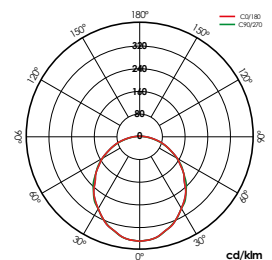

PC Opal

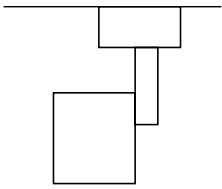

# Spaces

Lynx Led Empotrar

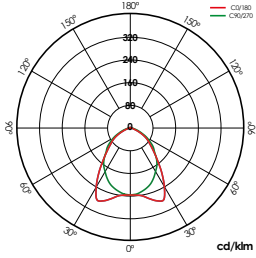

AL Especular

Lynx Led Line Empotrar

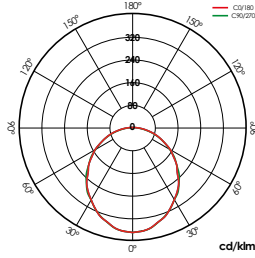

PC Opal

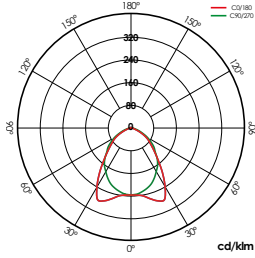

AL Especular

Lynx Led Pared

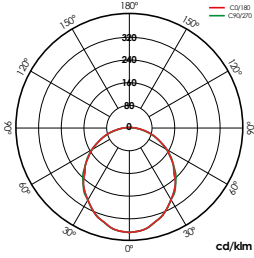

PC Opal

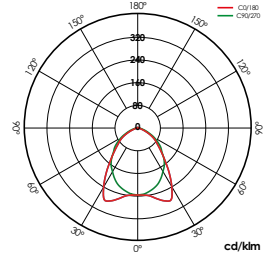

AL Especular

## Stania

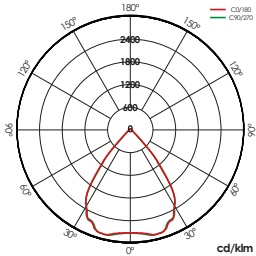

Aluminio Brillo (AL-BR)

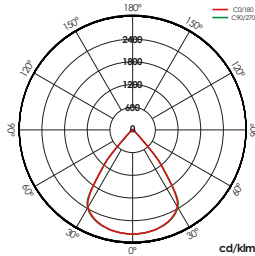

Blanco Mate (BL-MT)

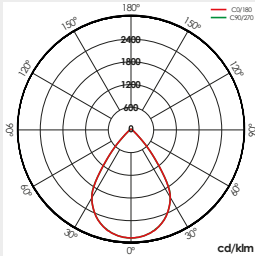

Aluminio Mate (AL-MT)

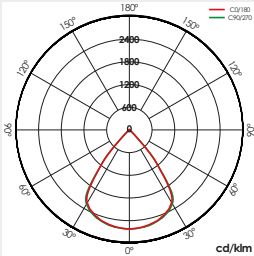

Negro Mate (NG-MT)

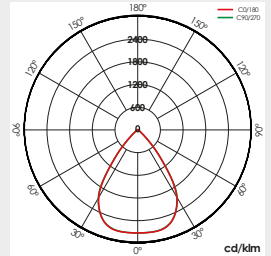

Dorado Mate (DO-MT)

## Stania

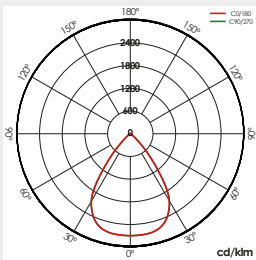

Cobre Mate (CO-MT)

## Kobe

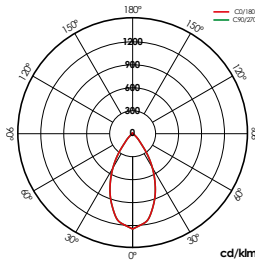

12W

## Kobe Switch

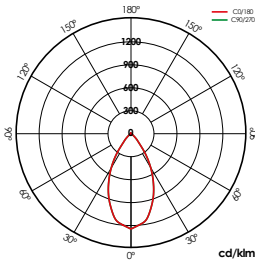

12W

## Tribola

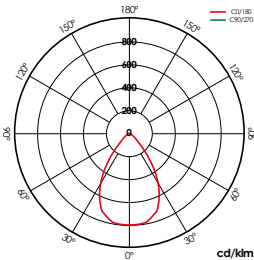

35W

## Ebro

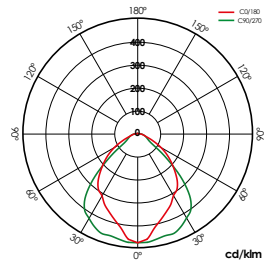

25,8W

## Miño

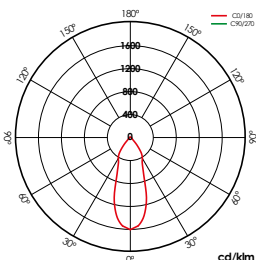

50W 40°

## Voltore I

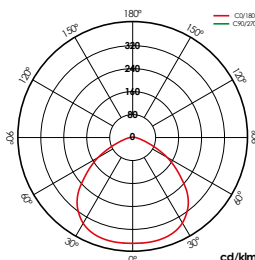

35W 100°

## Voltore II

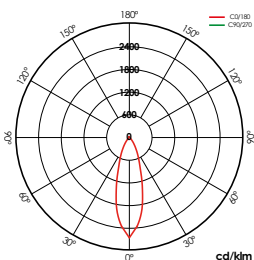

30°



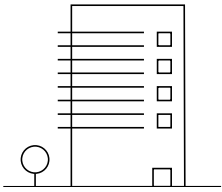

# Arquitectural

## Hexagon Play RGBW/ Hexagon Play RGBW Remoto

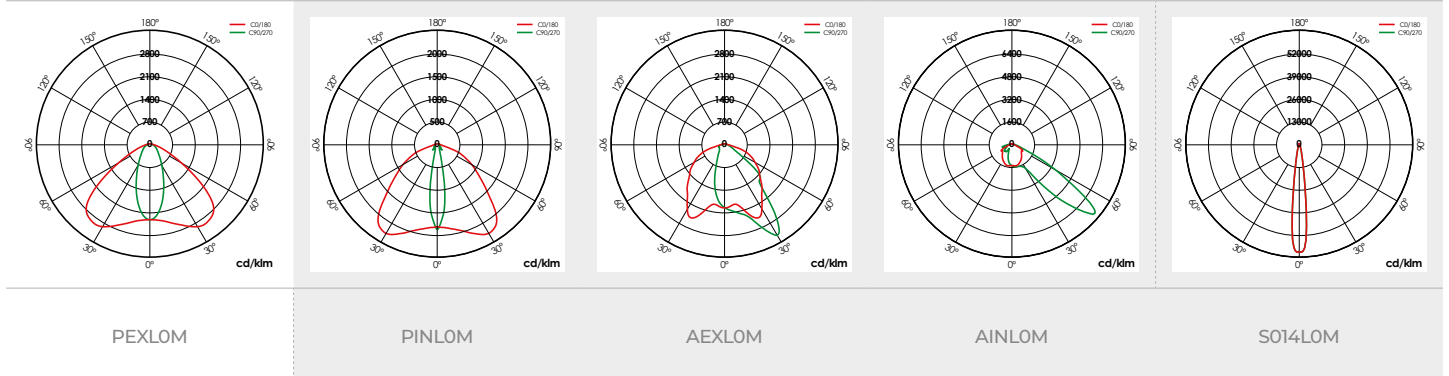

## Hexagon Play RGBW/ Hexagon Play RGBW Remoto

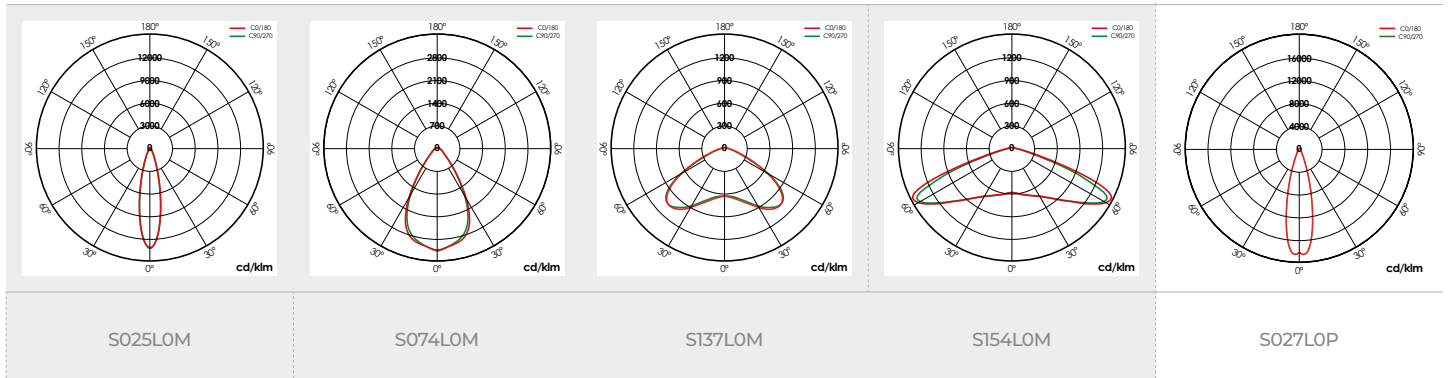

## Tanek ARQ

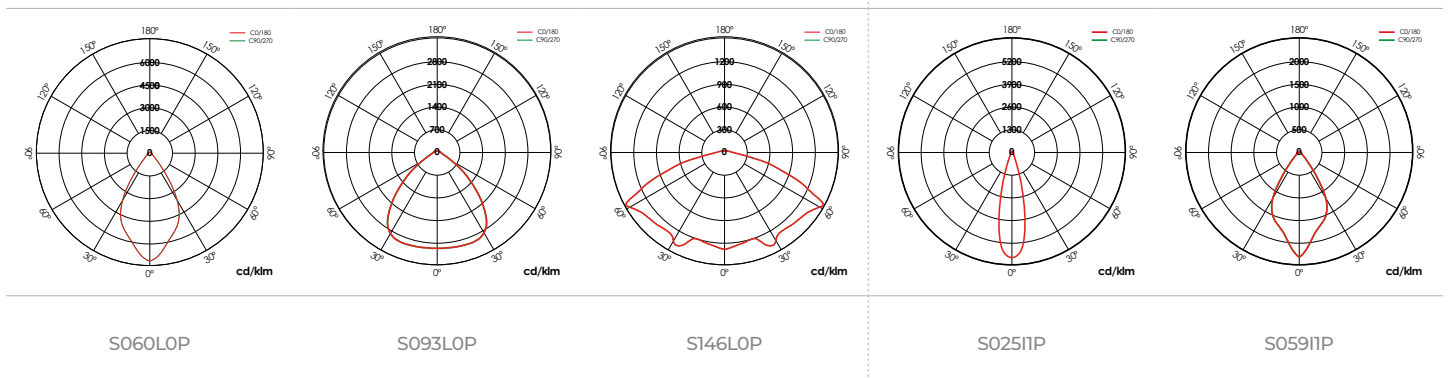

## Tanek ARQ RGBW

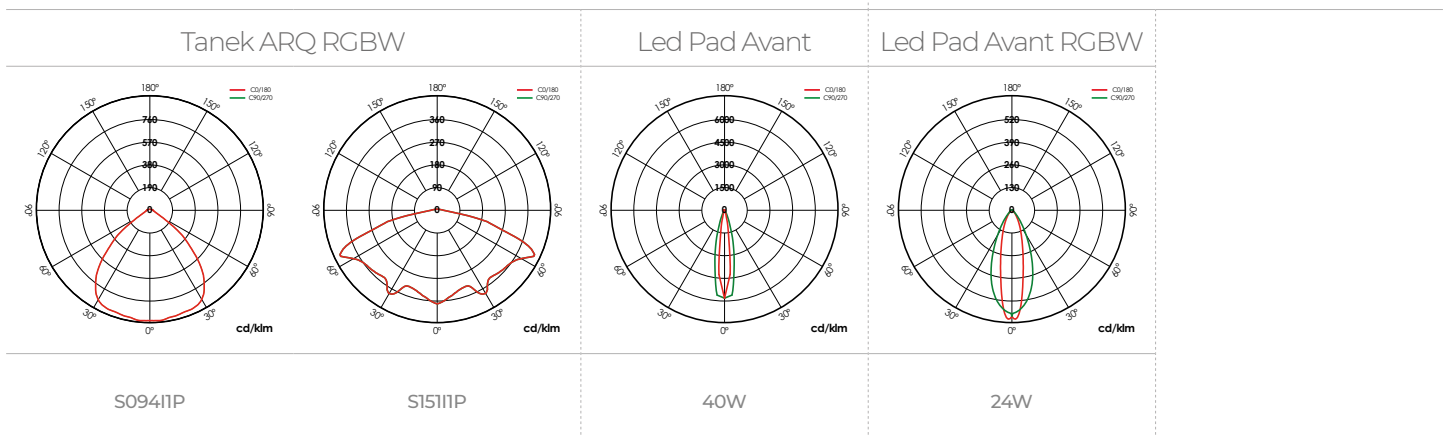

## Tanek ARQ RGBW

## Led Pad Avant

## Led Pad Avant RGBW

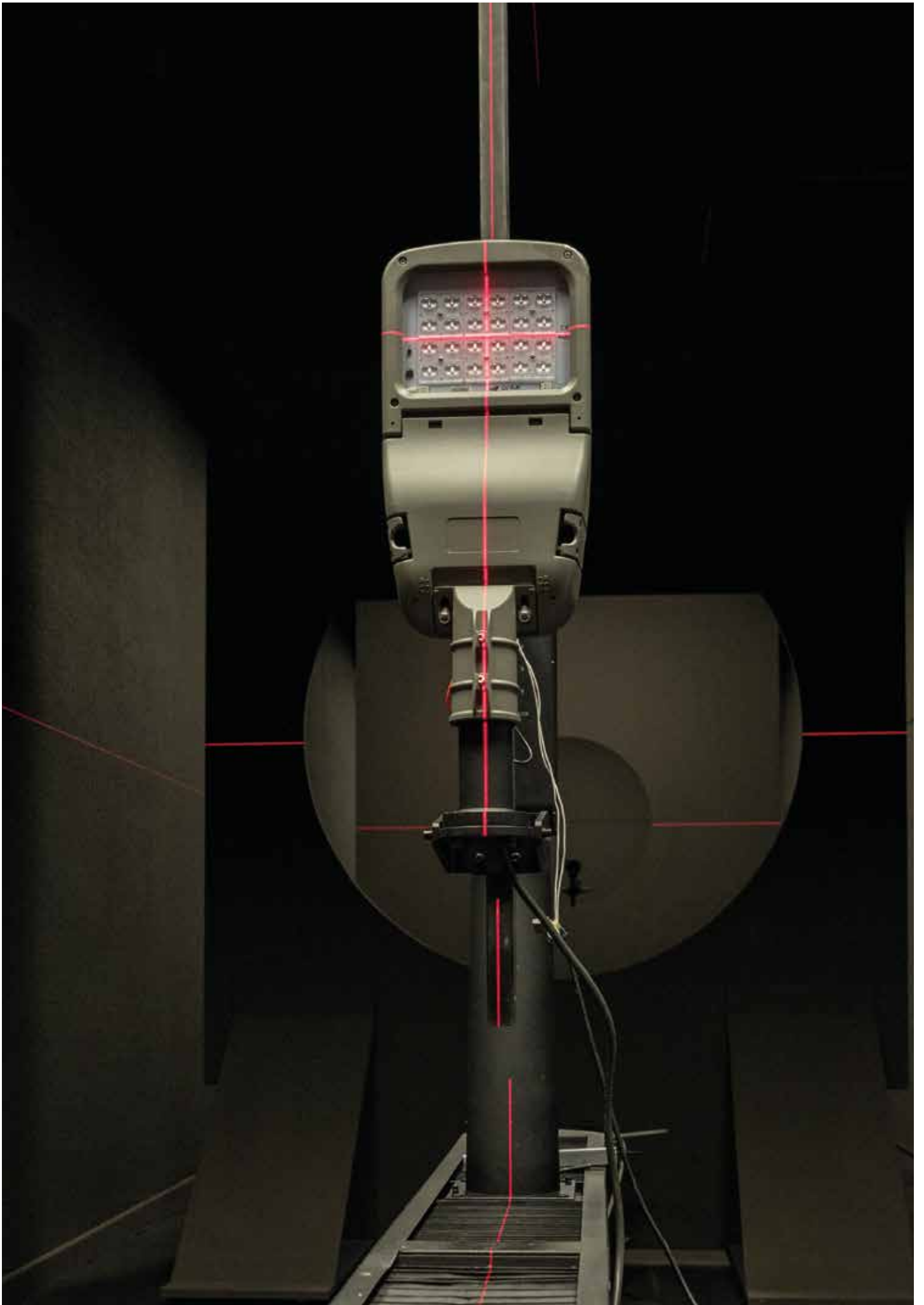

Handwritten notes and tables on a grey sheet of paper.

Table 1 (top left):

1	2	3	4	5	6	7	8	9	10
11	12	13	14	15	16	17	18	19	20
21	22	23	24	25	26	27	28	29	30
31	32	33	34	35	36	37	38	39	40
41	42	43	44	45	46	47	48	49	50
51	52	53	54	55	56	57	58	59	60
61	62	63	64	65	66	67	68	69	70
71	72	73	74	75	76	77	78	79	80
81	82	83	84	85	86	87	88	89	90
91	92	93	94	95	96	97	98	99	100

Table 2 (top middle):

1	2	3	4	5	6	7	8	9	10
11	12	13	14	15	16	17	18	19	20
21	22	23	24	25	26	27	28	29	30
31	32	33	34	35	36	37	38	39	40
41	42	43	44	45	46	47	48	49	50
51	52	53	54	55	56	57	58	59	60
61	62	63	64	65	66	67	68	69	70
71	72	73	74	75	76	77	78	79	80
81	82	83	84	85	86	87	88	89	90
91	92	93	94	95	96	97	98	99	100

Table 3 (top right):

1	2	3	4	5	6	7	8	9	10
11	12	13	14	15	16	17	18	19	20
21	22	23	24	25	26	27	28	29	30
31	32	33	34	35	36	37	38	39	40
41	42	43	44	45	46	47	48	49	50
51	52	53	54	55	56	57	58	59	60
61	62	63	64	65	66	67	68	69	70
71	72	73	74	75	76	77	78	79	80
81	82	83	84	85	86	87	88	89	90
91	92	93	94	95	96	97	98	99	100



Handwritten notes and tables on a white sheet of paper.

Table 4 (left side):

1	2	3	4	5	6	7	8	9	10
11	12	13	14	15	16	17	18	19	20
21	22	23	24	25	26	27	28	29	30
31	32	33	34	35	36	37	38	39	40
41	42	43	44	45	46	47	48	49	50
51	52	53	54	55	56	57	58	59	60
61	62	63	64	65	66	67	68	69	70
71	72	73	74	75	76	77	78	79	80
81	82	83	84	85	86	87	88	89	90
91	92	93	94	95	96	97	98	99	100

Table 5 (right side):

1	2	3	4	5	6	7	8	9	10
11	12	13	14	15	16	17	18	19	20
21	22	23	24	25	26	27	28	29	30
31	32	33	34	35	36	37	38	39	40
41	42	43	44	45	46	47	48	49	50
51	52	53	54	55	56	57	58	59	60
61	62	63	64	65	66	67	68	69	70
71	72	73	74	75	76	77	78	79	80
81	82	83	84	85	86	87	88	89	90
91	92	93	94	95	96	97	98	99	100

Handwritten notes and tables on a white sheet of paper.

Table 6 (left side):

1	2	3	4	5	6	7	8	9	10
11	12	13	14	15	16	17	18	19	20
21	22	23	24	25	26	27	28	29	30
31	32	33	34	35	36	37	38	39	40
41	42	43	44	45	46	47	48	49	50
51	52	53	54	55	56	57	58	59	60
61	62	63	64	65	66	67	68	69	70
71	72	73	74	75	76	77	78	79	80
81	82	83	84	85	86	87	88	89	90
91	92	93	94	95	96	97	98	99	100

Table 7 (right side):

1	2	3	4	5	6	7	8	9	10
11	12	13	14	15	16	17	18	19	20
21	22	23	24	25	26	27	28	29	30
31	32	33	34	35	36	37	38	39	40
41	42	43	44	45	46	47	48	49	50
51	52	53	54	55	56	57	58	59	60
61	62	63	64	65	66	67	68	69	70
71	72	73	74	75	76	77	78	79	80
81	82	83	84	85	86	87	88	89	90
91	92	93	94	95	96	97	98	99	100



Anexos

Annexes

Annexes

Anexos





## Grado de protección IP

IP protection degree  
Degré de protection IP  
Grau de proteção IP

Sistema de codificación para indicar los grados de protección proporcionados por una envolvente contra el acceso a partes peligrosas, la penetración de cuerpos sólidos extraños, la penetración de agua. Además suministra una información adicional unida a la referida protección. Se identifica mediante las siglas IP seguidas de dos cifras.

Coding system to indicate the degrees of protection provided by an enclosure against access to hazardous parts, penetration of solid foreign objects, ingress of water. Also provides additional information attached to that protection. It is identified by the acronym IP followed by two digits.

Système de codage pour indiquer les degrés de protection procurés par une enveloppe contre l'accès aux parties dangereuses, la pénétration de corps solides étrangers, la pénétration de l'eau. Fournit également des informations additionnelle attachée à cette protection. Il est identifié par des acronymes IP suivies de deux chiffres.

Sistema de codificação para indicar os graus de proteção conferido por um invólucro contra o acesso às partes perigosas, a penetração de corpos estranhos sólidos, a penetração de água. Também fornece informações adicionais ligados a essa proteção. É identificado pelas siglas IP seguidas por dois dígitos.

## Grado de Protección IP X1X2/IP protection degree X1X2/Degré de protection IP X1X2/Grau de proteção IP X1X2

### PRIMERA CIFRA (X1)/FIRST NUMBER (X1)/PREMIER NUMÉRO (X1)/PRIMEIRO NÚMERO (X1)

Cod.	PROTECCIÓN DEL MATERIAL/PROTECTION OF MATERIAL/ PROTECTION DE MATÉRIEL/PROTEÇÃO DE MATERIAL	PROTECCIÓN DE LAS PERSONAS/PROTECTION OF PERSONS/ PROTECTION DES PERSONNES/PROTEÇÃO DAS PESSOAS
IP 0X	Sin protección Without protection Sans protection Sem proteção	Sin protección Without protection Sans protection Sem proteção
IP 1X	Protegido contra la penetración de cuerpos sólidos de Ø superior o igual a 50mm. Protected against the penetration of solid objects bigger than or equal to Ø50mm. Protégé contre la pénétration de corps solides supérieurs ou égaux à Ø50mm. Protegido contra a entrada de objetos sólidos maiores ou iguais a Ø50mm.	Protegido contra el acceso con el dorso de la mano (contactos involuntarios). Protected against the access with the back of the hand (accidental contacts). Protégé contre l'accès avec le dos de la main (des contacts accidentels). Protegido contra o acesso com o dorso da mão (os contatos acidentais).
IP 2X	Protegido contra la penetración de cuerpos sólidos de Ø superior o igual a 12mm. Protected against penetration of solid objects bigger than or equal to Ø12mm. Protégé contre la pénétration de corps solides supérieurs ou égaux à Ø12mm. Protegido contra a entrada de objetos sólidos maiores ou iguais a Ø12mm.	Protegido contra el acceso con un dedo de la mano. Protected against the access with a finger. Protégé contre l'accès avec un doigt. Protegido contra o acesso com um dedo.
IP 3X	Protegido contra la penetración de cuerpos sólidos de Ø superior o igual a 2,5mm. Protected against penetration of solid objects bigger than or equal to Ø2,5mm. Protégé contre la pénétration de corps solides supérieurs ou égaux à Ø2,5mm. Protegido contra a entrada de objetos sólidos maiores ou iguais a Ø2,5mm.	Protegido contra el acceso con una herramienta de Ø2,5mm. Protected against the access with a Ø2,5mm tool. Protégé contre l'accès avec un outil Ø2,5mm. Protegido contra o acesso com uma ferramenta Ø2,5 mm.
IP 4X	Protegido contra la penetración de cuerpos sólidos de Ø superior o igual a 1mm. Protected against penetration of solid objects bigger than or equal to Ø1mm. Protégé contre la pénétration de corps solides supérieurs ou égaux à Ø1mm. Protegido contra a entrada de objetos sólidos maiores ou iguais a Ø1mm.	Protegido contra el acceso con un hilo de Ø1mm. Protected against the access with a Ø1mm wire. Protégé contre l'accès avec un fil de Ø1mm. Protegido contra o acesso com um fio de Ø1mm.
IP 5X	Protegido contra la suciedad (sin sedimentos nocivos). Protected against dirtness (no harmful deposits). Protégé contre la saleté (pas de dépôts nuisibles). Protegido contra sujeira (sem depósitos prejudiciais).	Protegido contra el acceso con un hilo de Ø1mm. Protected against the access with a Ø1mm wire. Protégé contre l'accès avec un fil de Ø1mm. Protegido contra o acesso com um fio de Ø1mm.
IP 6X	Totalmente protegido contra la suciedad (estanco). Totally protected against dirt (waterproof). Totalement protégé contre la poussière (étanche). Totalmente protegido contra poeira (à prova d'água).	Protegido contra el acceso con un hilo de Ø1mm. Protected against the access with a Ø1mm wire. Protégé contre l'accès avec un fil de Ø1mm. Protegido contra o acesso com um fio de Ø1mm.

### SEGUNDA CIFRA (X2)/SECOND NUMBER (X2)/DEUXIÈME NUMÉRO (X2)/SEGUNDO NÚMERO (X2)

Cod.	PROTECCIÓN DEL AGUA/WATER PROTECTION/PROTECTION DE L'EAU/PROTEÇÃO DA ÁGUA
IP X0	Sin protección Without protection Sans protection Sem proteção
IP X1	Protegido contra la caída vertical de gotas de agua (condensación). Protected against the vertically falling water drops (condensation). Protégé contre la chute verticale de gouttes d'eau (condensation). Protegido contra a queda vertical de gotas de água (condensação).
IP X2	Protegido contra la caída de gotas de agua hasta 15° de inclinación. Protected against the falling water drops up to 15° tilt. Protégé contre la chute des gouttes d'eau jusqu'à 15° d'inclinaison. Protegido contra a queda de gotas de água até 15° de inclinação.
IP X3	Protegido contra el agua de lluvia hasta 60° de inclinación. Protected against rain water up to 60° tilt. Protégé contre l'eau de pluie jusqu'à 60° d'inclinaison. Protegido contra água da chuva até 60° de inclinação.
IP X4	Protegido contra las proyecciones de agua desde cualquier dirección. Protected against water sprayed from any direction. Protégé contre les projections d'eau en toutes les directions. Protegido contra água borrifada de qualquer direção.
IP X5	Protegido contra los chorros de agua de manguera desde cualquier dirección. Protected against the water jets of a hose from any direction. Protégé contre les jets d'eau du tuyau en toutes les directions. Protegido contra os jactos de água da mangueira de qualquer direção.
IP X6	Protegido contra las proyecciones potente de agua de manguera, asimilable a los golpes de mar. Protected against powerful water jets from a hose, similar to sea waves. Protégé contre les jets d'eau puissants du tuyau, similaire aux vagues. Protegido contra jatos de água poderosos, comparável ao ondas do mar.
IP X7	Protegido contra los efectos de la inmersión temporal. Protected against the effects of temporary immersion. Protégé contre les effets d'une immersion temporaire. Protegido contra os efeitos de imersão temporária.
IP X8	Protegido contra los efectos de la inmersión prolongada en condiciones especiales. Protected against the effects of prolonged immersion in special conditions. Protégé contre les effets de l'immersion prolongée dans des conditions spéciales. Protegido contra os efeitos da imersão prolongada em condições especiais.

## Regulación

Dimming  
Gradation  
Regulação

Para pedidos de luminarias, con regulaciones DN PREPROGRAMADO y 8N PREPROGRAMADOS, en los que no se indique ninguna secuencia, las luminarias se servirán con una secuencia estándar (SECUENCIA 0) al 100% de luminosidad durante todas las horas de encendido.

For luminaire orders, with DN PREPROGRAMMED and 8N PREPROGRAMMED dimming, in which no sequence is indicated, the luminaires will be supplied with a standard sequence (SEQUENCE 0) at 100% every lighting hour.

Lors de la commande de luminaires avec les réglementations DN PREPROGRAMMED et 8N PREPROGRAMMED, dans lesquelles aucune séquence n'est indiquée, les luminaires sont livrés avec une séquence standard (SEQUENCE 0) avec une luminosité de 100% pendant toutes les heures de mise sous tension.

Ao encomendar luminárias com as normas DN PREPROGRAMED e 8N PREPROGRAMED, nas quais não é indicado nenhuma sequência, as luminárias serão fornecidas com uma sequência padrão (SEQUENCE 0) com 100% de brilho durante todas as horas de ligação.

### 8N (8 NIVELES PREPROGRAMADOS)/

### 8N (8 PREPROGRAMED LEVELS)//8N (8 NIVEAUX PRÉPROGRAMMÉS)//8N (8 NÍVEIS PRÉ-PROGRAMADOS)

Es una evolución del DN. En lugar de realizar 3 niveles a lo largo de la noche se realizan 8 niveles en consumo y tiempo de duración como se puede ver en el gráfico representado en este apartado. El driver de manera automática establece la media noche virtual en función del encendido y el apagado del cuadro de mando.

It is an evolution of DN. Instead of performing 3 levels throughout the night, 8 levels are made in consumption and duration time as can be seen in the graph represented in this section. The driver automatically sets virtual midnight based on turning the control panel on and off.

Il est une évolution de DN. Au lieu d'effectuer 3 niveaux pendant toute la nuit 8 niveaux sont effectués dans la consommation et la durée que vous pouvez voir dans le graphique représenté dans cette section. Le pilote définit automatiquement la nuit virtuelle moyenne en fonction de la mise sous tension et hors du tableau de bord.

É uma evolução do DN. Em vez de executar 3 níveis durante toda a noite 8 níveis são realizadas no consumo e duração como você pode ver no gráfico apresentado nesta secção. O driver define automaticamente a noite virtual média dependendo do ligar e desligar o scorecard.

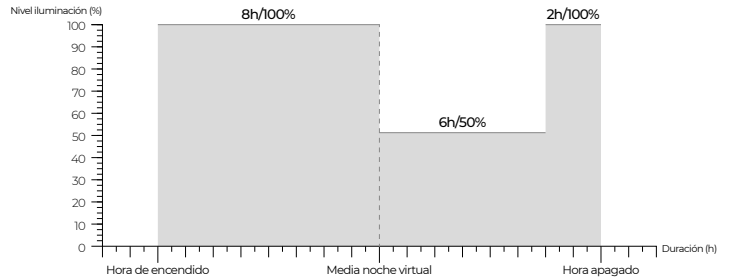
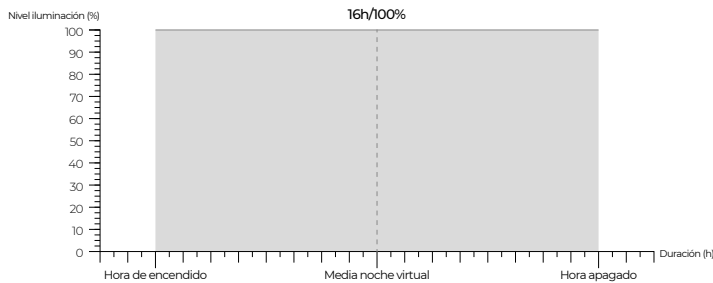

### Secuencia / Sequence / Séquence / Seqüência 0

16 horas al 100%.  
16 hours at 100%.  
16 heures à 200%.  
16 horas a 100%.

### Secuencia / Sequence / Séquence / Seqüência 1

6 horas de regulación al 50%, el resto al 100%.  
6 hours of regulation at 50%, the rest at 100%.  
6 heures de régulation à 50%, le reste à 100%.  
6 horas de regulação a 50%, o resto a 100%.

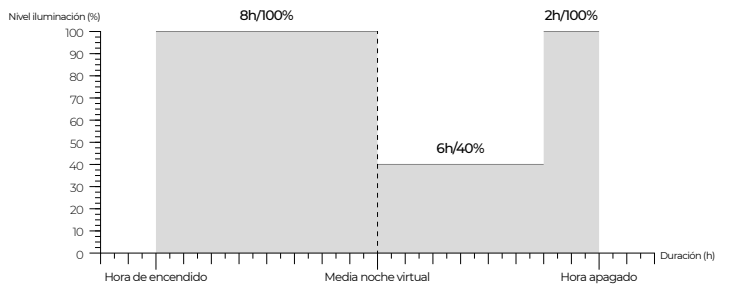
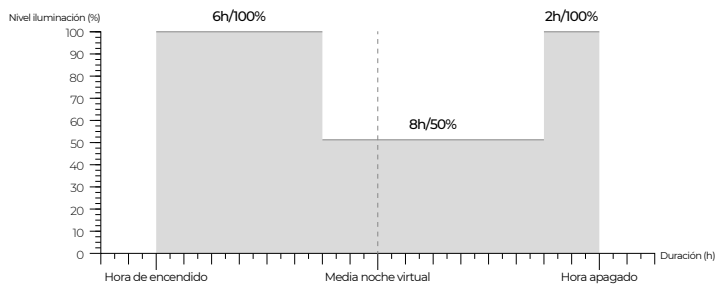

### Secuencia / Sequence / Séquence / Seqüência 2

8 horas de regulación al 50%, el resto al 100%.  
8 hours of regulation at 50%, the rest at 100%.  
8 heures de régulation à 50%, le reste à 100%.  
8 horas de regulação a 50%, o resto a 100%.

### Secuencia / Sequence / Séquence / Seqüência 3

6 horas de regulación al 40%, el resto al 100%.  
6 hours of regulation at 40%, the rest at 100%.  
6 heures de régulation à 40%, le reste à 100%.  
6 horas de regulação a 40%, o resto a 100%.

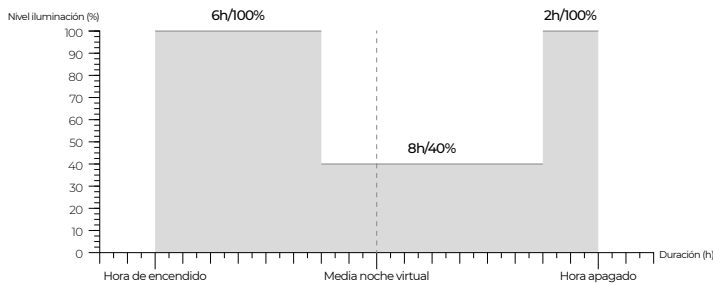

#### Secuencia / Sequence / Séquence / Seqüência 4

8 horas de regulación al 40%, el resto al 100%.  
 8 hours of regulation at 40%, the rest at 100%.  
 8 heures de régulation à 40%, le reste à 100%.  
 8 horas de regulação a 40%, o resto a 100%.

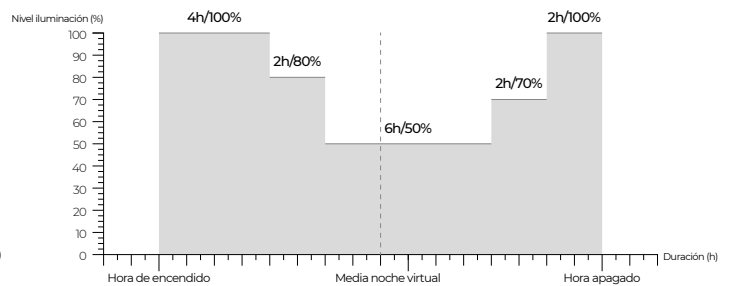

#### Secuencia / Sequence / Séquence / Seqüência 5

4 horas al 100%, 2 horas al 80%, 6 horas al 50%, 2 horas al 70% y las últimas 2 horas al 100%.  
 4 hours at 100%, 2 hours at 80%, 6 hours at 50%, 2 hours at 70% and the last 2 hours at 100%.  
 4 heures à 100%, 2 heures à 80%, 6 heures à 50%, 2 heures à 70% et les 2 dernières heures à 100%.  
 4 horas a 100%, 2 horas a 80%, 6 horas a 50%, 2 horas a 70% e as últimas 2 horas a 100%.

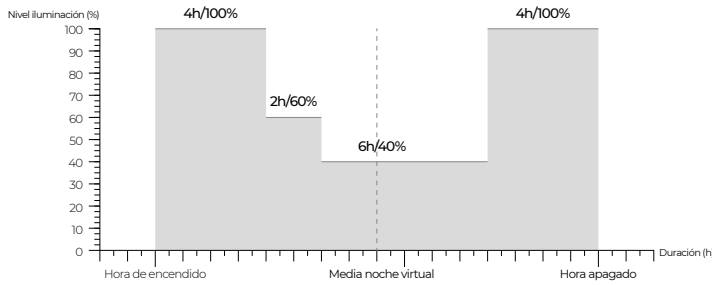

#### Secuencia / Sequence / Séquence / Seqüência 6

4 horas al 100%, 2 horas al 60%, 6 horas al 40%, y las últimas 4 horas al 100%.  
 4 hours at 100%, 2 hours at 60%, 6 hours at 40%, and the last 4 hours at 100%.  
 4 heures à 100%, 2 heures à 60%, 6 heures à 40% et les 4 dernières heures à 100%.  
 4 horas a 100%, 2 horas a 60%, 6 horas a 40% e as últimas 4 horas a 100%.

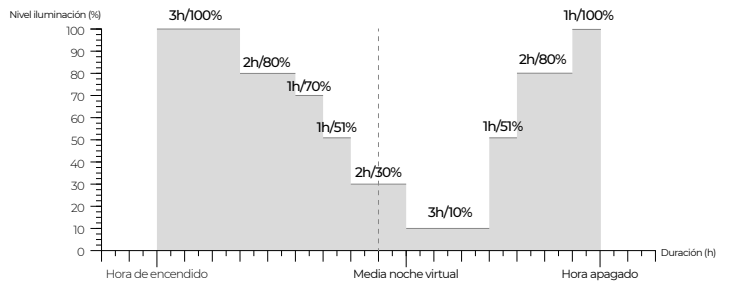

#### Secuencia / Sequence / Séquence / Seqüência 7

3 horas al 100%, 2 horas al 80%, 1 hora al 70%, 1 hora al 51%, 2 horas al 30%, 3 horas al 10%, 1 hora al 51%, 2 horas al 80% y la última hora al 100%.  
 3 hours at 100%, 2 hours at 80%, 1 hour at 70%, 1 hour at 51%, 2 hours at 30%, 3 hours at 10%, 1 hour at 51%, 2 hours at 80% and the last hour at 100%.  
 3 heures à 100%, 2 heures à 80%, 1 heure à 70%, 1 heure à 51%, 2 heures à 30%, 3 heures à 10%, 1 heure à 51%, 2 heures à 80% et la dernière heure à 100%.  
 3 horas a 100%, 2 horas a 80%, 1 hora a 70%, 1 hora a 51%, 2 horas a 30%, 3 horas a 10%, 1 hora a 51%, 2 horas a 80% e a última hora a 100%.

#### DN/LM (DOBLE NIVEL CON LÍNEA DE MANDO)/

#### DN/LM (TWO-LEVEL WITH COMMAND-LINE)/ DN/LM (BI-PUISSANCE AVEC FIL PILOTE)/ DN/LM (DN SEM LINHA DE COMANDOS)

Se debe elegir el tipo de activación de la regulación entre dos posibles, perfiles 5 y 6. Según la programación elegida la regulación del 50% en el nivel de iluminación tendrá lugar cuando la tensión de la línea de mando sea 230V (Perfil 6) o 0V. (Perfil 5).

You must choose the type of activation of the regulation between two possible, according to the graph represented in this section. According to the chosen programming, the 50% regulation in the illumination level will be realized when the voltage of the control line is 230V (Profile 6) or 0V (Profile 5).

Vous devez sélectionner le type de régulation d'activation entre les deux possibles, selon le graphique représenté dans cette section. Selon le règlement du programme choisi 50% au niveau de l'éclairage, il sera fait lorsque la tension de la ligne est le contrôle de 230V (Profile 6) ou 0V (Profile 5).

Você deve selecionar o tipo de ativação de regulação entre duas possível, de acordo com o gráfico mostrado nesta seção. De acordo com o regulamento do programa escolhido de 50% no nível de iluminação será feita quando a tensão da rede é o controle de 230V (Perfil 6) ou 0V (Perfil 5).

Las programaciones son excluyentes

The schedules are exclusive

Les horaires sont mutuellement exclusifs

Horários são mutuamente exclusivos

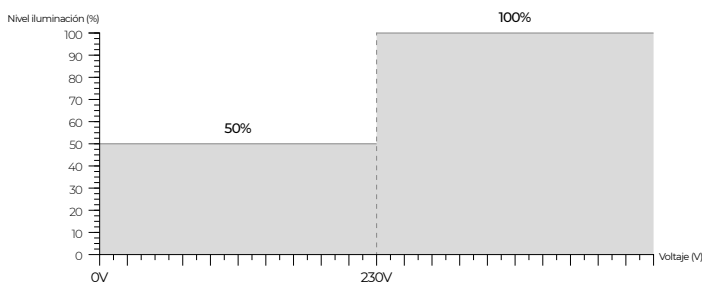

DN/LM1

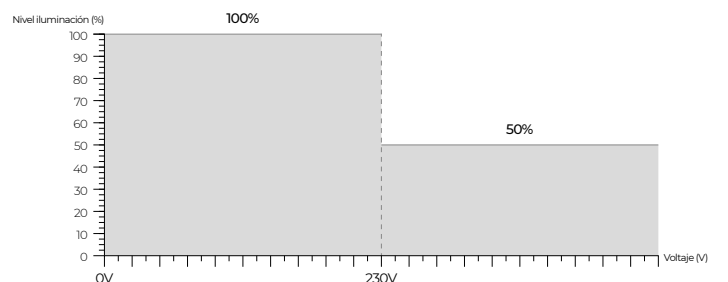

DN/LM2



**Iluminación:** Aplicación de luz a una escena, objeto o a sus alrededores.

**Iluminación general:** Iluminación uniforme de un espacio.

**Iluminación de acento:** iluminación diseñada para aumentar considerablemente la iluminancia de un área limitada u objeto con relación a la de su entorno.

**Iluminación directa:** iluminación mediante luminarias con una distribución de intensidad luminosa tal que la parte del flujo luminoso emitido que alcanza directamente el plano de trabajo es del 90% al 100%.

**Iluminación indirecta:** iluminación mediante luminarias con una distribución de intensidad luminosa tal que la parte del flujo luminoso que llega al plano de trabajo después de ser reflejado por los paramentos del escenario o por la propia luminaria se encuentra entre el 0 y el 10%.

**Iluminancia (E):** flujo luminoso que incide sobre una superficie. Su unidad es el lux.

**Iluminancia media en el plano horizontal (E):** iluminancia promedio sobre el área especificada. El número mínimo de puntos a considerar en su cálculo, estará en función de índice del local (K) y de la obtención de un reparto cuadrículado simétrico.

**Iluminancia media horizontal mantenida (Em):** valor por debajo del cual no debe descender la iluminación media en el área especificada. Es la iluminancia media durante todo el periodo anterior al momento de realizar el mantenimiento programado.

**Factor de mantenimiento (Fm):** cociente entre la iluminancia media sobre el plano de trabajo después de un cierto periodo de uso de una instalación de alumbrado y la iluminancia media obtenida en la instalación cuando está nueva.

**Índice de reproducción cromática:** Valoración de la capacidad de una fuente de luz para reproducir fielmente los colores con respecto a un iluminante de referencia.

**Intensidad luminosa (I):** Es el cociente del flujo luminoso que sale de la fuente y que se propaga en un elemento de ángulo sólido contenido en la dirección por este elemento de ángulo sólido. Su unidad es la candela (cd).

**Flujo luminoso:** Es el flujo radiante emitido por una lámpara dentro del espectro visible, y además, ponderado por la curva de sensibilidad relativa. Su unidad es el lm.

**Luminancia (L):** Es la relación entre la intensidad luminosa en dicha dirección y la superficie aparente de la misma. Su unidad es cd/m<sup>2</sup>.

**Reflectancia:** La reflectancia es la proporción de luz reflejada por una superficie y se determina comparando los lúmenes que inciden en ella (iluminancia) con los que refleja (luminancia).

**Refracción:** Fenómeno que se produce en ciertos materiales que dejan pasar la luz a través de ellos.

**Eficiencia y/o rendimiento de una luminaria (η):** Relación entre el flujo emitido por la luminaria y el emitido por la/s lámpara/s.

**Uniformidad media (Um):** Es la relación entre la iluminancia mínima y la iluminancia media en el plano.

**Utilancia (ηn):** Relación entre el flujo luminoso que recibe la superficie iluminada, y el flujo luminoso emitido por la luminaria.

**Factor de utilización (u):** Relación entre el flujo que llega a la superficie y el emitido por la lámpara.

**Vida media:** N° de horas de funcionamiento para el que han fallado el 50% de las lámparas correspondientes a una muestra suficientemente representativa después de funcionar en condiciones de prueba.

**Direct lighting:** lighting by luminaries with a luminous intensity distribution which ensures a luminous flux emitted directly to the working plane from 90% to 100%.

**Indirect lighting:** lighting by luminaries with the luminous intensity distribution in a way that the luminous flux which reaches the working plane after being reflected by the faces of the scenario or for the luminaire itself, it is between the 0 and 10%

**Illuminance (E):** luminous flux that fall upon a surface. Its unit is the lux.

**Average illuminance on the horizontal plane (E):** average illuminance on the specific area. The minimum number of points to be taken into account in its estimation depends on the local index (K) and the getting of the symmetric squared distribution.

**Horizontal average illuminance maintained (Em):** value below which average lighting should not descend in the specific area. It is the average illuminance during the whole period before the moment of doing the scheduled maintenance.

**Maintenance factor (Fm):** it is the ratio between the average illuminance on the working plane, after some usage time in a lighting installation, and the average illuminance scored in the installation when it is new.

**Color rendering index:** assessment for the capacity of the light source to reproduce accurately the colors under a reference illuminant.

**Luminous intensity (I):** it is the ratio between the luminous flux which comes from the source and it spreads through in a particular direction by a solid-angle element. Its unit is the candela (cd).

**Luminous flux:** it is the measure of the perceived power of light, adjusted to reflect the varying sensitivity of the human eye to different wavelengths of light. Its unit is the lumen (lm)

**Luminance (L):** Relationship between the light intensity in that direction and the apparent surface of itself. Its unit is the cd/m<sup>2</sup>.

**Reflectance:** it is the quantity of light reflected by a surface and it is determined by comparing the lumens which impact on it (illuminance) with these ones that reflect (luminance).

**Refraction:** Phenomenon that takes place in some materials that let the light in through them.

**Efficiency and/or performance of a luminaire (η):** Relationship between the flux emitted by the luminaire and emitted by the lamp/s.

**Average uniformity (Um):** Relationship between minimum illuminance and average illuminance on the plane.

**Utilance (ηn):** Relationship between the luminous flux received by the illuminated surface and the luminous flux emitted by the luminaire.

**Utilization factor (u):** Relationship between the flux reaching the surface and emitted by the lamp.

**Lifetime:** number of operating hours in which have been failed the 50% of the lamps from a sufficiently representative sample after operating under test conditions.

**Useful life:** number of operating hours after which the total flux from an installation, under specific conditions, registers 30% depreciation.

**Luminous depreciation:** It's the descent of the emitted luminous flux by a lamp along his life. It's expressed in % of initial flux or hours/Flux.

**Luminous efficacy of a source:** It's the quotient of the emitted luminous flux and absorbed power. Its unit is the lm/W.

**Éclairage:** Application de lumière sur une scène, objet ou ses environs.

**Éclairage général:** éclairage uniforme d'une espace.

**Éclairage d'accentuation:** éclairage conçu pour augmenter d'une manière considérable l'éclairage d'une zone limitée ou objet par rapport à ses environs.

**Éclairage direct:** éclairage par luminaires avec une distribution de telle intensité lumineuse que la part du flux lumineux émis qui atteint directement le plan de travail es du 90% au 100%.

**Éclairage indirect:** par luminaires avec une distribution de telle intensité lumineuse tal que la part du flux lumineux émis qui atteint le plan de travail après être refleté par les parements de la scène ou par la luminaire même se trouve entre le 0 et le 10%.

**Éclairage (E):** flux lumineux que influe sur une surface. Son unité est le lux.

**Éclairage moyen sur le plan horizontal (E):** éclairage moyen sur la zone spécifiée. La quantité minimum de points à considérer dans son calcul, va dépendre de l'indice du local (K) et de l'obtention d'une distribution carrée symétrique.

**Éclairage moyen horizontal maintenu (Em):** valeur au-dessous duquel l'éclairage moyen de la zone spécifiée ne doit pas descendre. C'est éclairage moyen pendant toute la période antérieure au moment de réaliser la maintenance programmée.

**Facteur de maintenance (Fm):** quotient entre l'éclairage moyen sur le plan de travail après une période d'utilisation d'une installation d'éclairage et l'illumination moyenne obtenue dans la nouvelle installation.

**Taux de reproduction chromatique:** Évaluation de la capacité d'une source de lumière pour reproduire avec fidélité les couleurs par rapport à un illuminant de référence.

**Intensité lumineuse(I):** c'est le quotient du flux lumineux qui sort de la source y qui se propage dans un élément d'angle solide contenu dans la direction par cet élément d'angle solide. Son unité c'est la chandelle (cd).

**Flux lumineux:** C'est le flux radiant émis par une lampe dans le spectre visible, et de plus, pondéré par la courbe de sensibilité relative. Son unité c'est le lm.

**Luminance (L):** C'est la relation entre l'intensité lumineuse en cette direction et la surface apparente de la même. Son unité c'est le cd/m<sup>2</sup>.

**Réfléchissance:** La réfléchissance c'est la proportion de lumière réfléctée par une surface y se détermine en comparant les lumens qui ont une incidence sur elle luminance avec lesquels elle los reflète luminance.

**Réfraction:** Phénomène qui se produit dans quelques matériaux qui laissent passer la lumière.

**Efficacité et/ou rendement d'une lampe (η):** Relation entre le flux émis par la luminaire et par la/les lampe/s.

**Uniformité moyenne (Um):** C'est la relation entre la luminance minimum et la luminance moyenne sur le plan.

**Utilance (η<sub>u</sub>):** Relation entre le flux lumineux reçu par la surface illuminée, et le flux lumineux émis par la luminaire.

**Facteur d'utilisation (u):** Relation entre le flux qui arrive à la surface et le flux émis par la lampe.

**Durée de vie moyenne:** N° d'heures de fonctionnement pour lequel 50% des lampes ont manqué correspondents á un modèle suffisamment représentatif après avoir fonctionné dans des conditions d'épreuve.

**Durée de vie:** N° d'heures de fonctionnement après lequel le flux

**Iluminação:** Aplicação de luz a um lugar, objeto ou a suas imediações.

**Iluminação general:** Iluminação uniforme de um espaço.

**Iluminação de acento:** iluminação desenhada para aumentar consideravelmente a iluminância de uma área limitada ou objeto com relação à do seu ambiente.

**Iluminação direta:** iluminação através de luminárias com uma distribuição de intensidade luminosa tal que a parte do fluxo luminoso emitido que alcança diretamente o plano de trabalho é de 90% a 100%.

**Iluminação indireta:** iluminação através de luminárias com uma distribuição de intensidade luminosa tal que a parte do fluxo luminoso que chega ao plano de trabalho depois de ser refletido pelos paramentos do lugar ou pela própria luminária se encontra entre 0 e 10%.

**Iluminância (E):** fluxo luminoso que incide sobre uma superfície. Sua unidade é o lux.

**Iluminância média no plano horizontal (E):** Iluminância média sobre a área especificada. O número mínimo de pontos a considerar para o seu cálculo, estará em função do índice do local (K) e da obtenção de um reparto quadriculado simétrico.

**Iluminância média horizontal mantida (Em):** valor por debaixo do qual não se deve descender a iluminação média na área especificada. É a Iluminância média durante todo o período anterior ao momento de realizar a manutenção programada.

**Fator de manutenção (Fm):** cociente entre a iluminância média sobre o plano de trabalho depois de um certo período de uso de uma instalação de alumbrado e a iluminância média obtida na instalação quando está nova.

**Índice de reprodução cromática:** Valoração da capacidade de uma fonte de luz para reproduzir fielmente as cores em relação a um iluminante de referência.

**Intensidade Luminosa (I):** É o cociente do fluxo luminoso que sai da fonte e que se propaga num elemento de ângulo sólido contido na direção por este elemento de ângulo sólido. Sua unidade é a candela (cd).

**Fluxo luminoso:** É o fluxo radiante emitido por uma lâmpada dentro do espectro visível, e também, ponderado pela curva de sensibilidade relativa. Sua unidade é o lm.

**Iluminância (L):** É a relação entre a intensidade luminosa numa direção e a superfície aparente da mesma. Sua unidade é cd/m<sup>2</sup>.

**Refletância:** A refletância é a proporção de luz refletida por uma superfície e se determina comparando os lúmenes que incidem nela (Iluminância) com os que reflete (luminância).

**Refração:** Fenômeno que se produz em certos materiais que deixam passar a luz através deles.

**Eficiência e/ou rendimento de uma luminária (η):** Relação entre o fluxo emitido pela luminária e o emitido pela/s lâmpada/s.

**Uniformidade média (Um):** É a relação entre a Iluminância mínima e a Iluminância média no plano.

**Utilância (η<sub>u</sub>):** Relação entre o fluxo luminoso que recebe a superfície iluminada, e o fluxo luminoso emitido pela luminária.

**Fator de utilização (u):** Relação entre o fluxo que chega a superfície e o emitido pela lâmpada.

**Vida média:** N° de horas de funcionamento quando falharam 50% das lâmpadas correspondentes a uma amostra suficientemente representativa depois de funcionar em condiciones de prova.

**Vida útil:** Número de horas de funcionamento depois das quais

**Vida útil:** Número de horas de funcionamiento después del cual el flujo total de una instalación, bajo condiciones especificadas, sufre una depreciación del 30%.

**Depreciación luminosa:** Es el descenso del flujo luminoso emitido por una lámpara a lo largo de su vida. Se expresa en % de flujo inicial o en horas/Flujo.

**Eficacia luminosa de una fuente:** Es el cociente entre el flujo luminoso emitido y la potencia absorbida. Su unidad es el lm/W.

**Arrancador:** Equipo auxiliar que hace posible el encendido de lámparas de descarga generando puntas de tensión.

**Balasto:** Elemento que limita la intensidad que circula por la/s lámpara/s al valor requerido.

**Casquillo:** Parte de la lámpara que posibilita una sujeción mecánica en el portalámparas y al mismo tiempo permite la conexión eléctrica de la fuente de luz con la red.

**Equipo auxiliar:** Equipos eléctricos o electrónicos asociados a la lámpara, diferentes para cada tipo de lámpara. Su función es el encendido y control de las condiciones de funcionamiento de una lámpara. Estos equipos auxiliares, salvo cuando son electrónicos, están formados por combinación de arrancador/ cebador, balasto y condensador.

**Flujo hemisférico superior instalado emitido por una luminaria (FHS):** Es el flujo dirigido por encima del plano horizontal que pasa por la fuente. El flujo hemisférico se expresa en % del flujo total emitido por la luminaria.

**Implantación bilateral al tresbolillo:** Tipo de implantación de luminarias en la que los puntos de luz se sitúan en ambos lados de la vía de tráfico al tresbolillo o en zigzag, se utilizará principalmente cuando la anchura de la calzada A sea de 1 a 1,5 veces la altura H de montaje de las luminarias, considerándose más idóneo el intervalo de 1 a 1,3H.

**Implantación bilateral pareada:** Tipo de implantación de luminarias en la que los puntos de luz se sitúan en ambos lados de la vía de tráfico, uno opuesto al otro, se utilizará normalmente cuando la anchura de la calzada A sea 1,5 veces la altura H de montaje de las luminarias, considerándose más adecuado cuando la anchura supere 1,3 veces la altura H.

**Implantación central o axial:** Tipo de implantación de luminarias en la que los puntos de luz se implantan en columnas o báculos de doble brazo, situados en la mediana central, cuando la anchura de ésta esté comprendida entre 1 y 3 m.

**Implantación unilateral:** Tipo de implantación de luminarias en la que los puntos de luz se sitúan en un mismo lado de la vía de tráfico, se utilizará generalmente cuando la anchura A de la calzada sea igual o inferior a la altura H de montaje de las luminarias.

**Uniformidad media (Uo):** Es la relación entre la luminancia mínima y la luminancia media en la calzada.

**Uniformidad Longitudinal (UI):** Es la relación entre la luminancia mínima y la luminancia máxima en la línea central de un carril de la calzada. Cuando existen varios carriles, siempre se toma el valor más bajo. La uniformidad longitudinal debe ser siempre superior a 0,5 para situaciones simples y de 0,7 situaciones complejas.

**Useful life:** Number of operating hours after which the total flow of an installation, under specified conditions, suffers a 30% depreciation.

**Luminous depreciation:** It is the decrease in the luminous flux emitted by a lamp throughout its life. It is expressed in % of initial flow or in hours/Flow.

**Luminous efficacy of a source:** It is the ratio between the luminous flux emitted and the power absorbed. Its unit is lm/W.

**Starter:** Auxiliary equipment that enables the ignition of the discharge lamps generating voltage spikes.

**Ballast:** Element that limits the current flowing through the lamp/s to the required value.

**Cap:** Part of the lamp that allows a mechanical fastening into the lamp holder and at the same time provides the electrical connection of the light source with the network.

**Auxiliary equipment:** Electrical and electronic equipment associated to the lamp, different for each kind of lamp. Its function is to start and control the operating conditions of a lamp. These auxiliary equipments, except where there are electronics, are formed by the combination of ignitor, ballast and condenser.

**Upper Light Output (ULOR):** it is the flux headed above the horizontal plane which goes through the source. It is expressed in % of total flux emitted by the luminaire.

**Bilateral zigzag implantation:** the type of luminaires establishment in which the light spots are situated in both sides of the roadway in zigzag. It uses mainly when the width of the road A is from 1 to 1.5 times the height H of installation, being more appropriate the interval which goes from 1 to 1.3 H.

**Bilateral semi-detached implantation:** the type of luminaires establishment in which the light spots are situated in both side of the roadway, opposite to each other. It uses mainly when the width of the road A is from 1 to 1.5 times the height H of installation, being more appropriate the interval which goes from 1 to 1.3 H.

**Central implantation:** the type of luminaires establishment in where the light spots are set up in columns or pole with double bracket, placed along the center median, when its width is between 1 and 3m.

**Unilateral implantation:** the type of luminaires establishment in which the light spots are located in the same side of the roadway, it uses normally when the width A of the road is less than or equal to the height H in the installation of the luminaires.

**Average uniformity (Uo):** Relationship between minimum luminance and average luminance on the road.

**Longitudinal uniformity (UI):** it is the relation between the minimum and maximum luminance in the central line of the roadway. In the case of many lanes, we take the lower value. The longitudinal uniformity must be higher to 0.5 in simple situations and 0.7 in complex situations.

**Durée de vie utile:** Nombre d'heures de fonctionnement au bout desquelles le débit total d'une installation, dans des conditions déterminées, subit une dépréciation de 30 %.

**Dépréciation lumineuse:** C'est la descente du flux lumineux émis par une lampe pendant sa vie. On la mesure en % du flux initial ou en heures/Flux.

**Efficacité lumineuse d'une source:** C'est le quotient entre le flux lumineux émis et la puissance absorbée. Son unité c'est le lm/W.

**Arracheur:** Equipe auxiliaire qui fait possible l'allumage de lampes de décharge en générant des pointes de tension.

**Ballast:** élément qui limite l'intensité qui circule dans la/les lamp/s avec la valeur exigée.

**Culot:** Part de la lampe qui fait possible une fixation mécanique dans la douille et permet à la fois le branchement électrique de la source de lumière avec le réseau.

**Appareillage auxiliaire:** Appareillages électriques ou électroniques associés à la lampe, différents pour chaque sorte de lampe. Sa fonction c'est l'allumage et contrôle des conditions de fonctionnement d'une lampe. Ces appareillages auxiliaires, sauf quand ils sont électroniques, sont formés par la combinaison de arracheur/démarrateur, ballast et condensateur.

**Flux hémisphérique supérieur installé émis par une luminaire (FHS):** C'est le flux dirigé par dessus du plan horizontal que passe par la source. Le flux hémisphérique se mesure en % du flux total émis par la luminaire.

**Implantation bilatérale triangulaire ou en zigzag:** Sorte d'implantation de luminaires dans laquelle les points d'éclairage sont situés sur les deux côtés de la route triangulaire ou en zigzag, s'utilise surtout quand la largeur de la chaussée A est de 1 à 1,5 fois la largeur H du montage des luminaires, considérée comme plus convenable l'intervalle de 1 à 1,3H.

**Implantation bilatérale appariée:** Sorte d'implantation de luminaires dans laquelle les points d'éclairage sont situés sur les deux côtés de la route, l'un opposé à l'autre, s'utilise normalement quand la largeur de la chaussée A est 1,5 fois la largeur H de montage des luminaires, considérée comme plus convenable quand la largeur dépasse 1,3 fois la largeur H.

**Implantation centrale ou axiale:** Sorte d'implantation de luminaires dans laquelle les points d'éclairage sont implantés en colonnes ou crosses de double bra, situés sur la ligne blanche centrale, quand sa largeur est entre 1 y 3 m.

**Implantation unilatérale:** Sorte d'implantation de luminaires dans laquelle les points d'éclairage sont situés sur le même côté de la route, utilisée en général quand la largeur A de la chaussée est égale ou inférieure à la largeur H du montage des luminaires.

**Uniformité moyenne (Uo):** C'est la relation entre la lumenance minimum et la moyenne de la route.

**Uniformité Longitudinale (Ul):** C'est la relation entre la lumenance minimum et la maximum sur la ligne centrale d'une voie de la chaussée. Quand il'y a plusieurs voies, on prend toujours la valeur plus basse. L' uniformité longitudinale doit être toujours supérieure à 0,5 pour des situations simples et de 0,7 pour des situations complexes.

**Vida útil:** Número de horas de operação após as quais a vazão total de uma instalação, sob condições especificadas, sofre uma depreciação de 30%.

**Depreciação luminosa:** É o descenso do fluxo luminoso emitido por uma lâmpada ao longo da sua vida. Se expressa em % de fluxo inicial ou em horas/Fluxo.

**Eficácia luminosa de uma fonte.** É o cociente entre o fluxo luminoso emitido e a potência absorvida. Sua unidade é o lm/W.

**Arranque:** Equipamento auxiliar que torna possível acender lâmpadas de descarga gerando pontas de tensão.

**Balastro:** Elemento que limita a intensidade que circula pela/s lâmpada/s ao valor requerido.

**Casquilho:** Parte da lâmpada que possibilita uma sujeição mecânica no porta-lâmpada e ao mesmo tempo permite a conexão elétrica da fonte de luz com a rede.

**Equipamento auxiliar:** Equipamentos elétricos ou eletrônicos associados à lâmpada, diferentes para cada tipo de lâmpada. Sua função é acender e controlar as condições de funcionamento de uma lâmpada. Estes equipamentos auxiliares, salvo quando são eletrônicos, estão formados pela combinação de arrancador, balastro e condensador.

**Fluxo hemisférico superior instalado emitido por uma luminária (FHS):** É o fluxo dirigido por encima do plano horizontal que passa pela fonte. O fluxo hemisférico se expressa em % do fluxo total emitido pela luminária.

**Implantação bilateral ou em zigue-zague:** Tipo de implantação de luminárias na qual os pontos de luz se situam em ambos os lados da via de tráfego ou em zigue-zague, se utilizará principalmente quando a largura da estrada A seja de 1 a 1,5 vezes a altura H de montagem das luminárias, considerando-se mais idôneo o intervalo de 1 a 1,3H.

**Implantação bilateral pareada:** Tipo de implantação de luminárias na qual os pontos de luz se situam em ambos os lados da via de tráfego, um oposto ao outro, se utilizará normalmente quando a largura da estrada A seja 1,5 vezes a altura H de montagem das luminárias, considerando-se mais adequado quando a largura supere 1,3 vezes a altura H.

**Implantação central ou axial:** Tipo de implantação de luminárias na qual os pontos de luz se implantam em colunas ou báculos de duplo braço, situados na mediana central, quando a largura desta esteja compreendida entre 1 e 3 m.

**Implantação unilaterial:** Tipo de implantação de luminárias na qual os pontos de luz se situam num mesmo lado da via de tráfego, se utilizará geralmente quando a largura A da estrada seja igual ou inferior à altura H de montagem das luminárias.

**Uniformidade média (Uo):** É a relação entre a iluminância mínima e a iluminância média na estrada.

**Uniformidade Longitudinal (Ul):** É a relação entre a iluminância mínima e a iluminância máxima na linha central de uma pista da estrada. Quando existem várias pistas, sempre se toma o valor mais baixo. A uniformidade longitudinal deve ser sempre superior a 0,5 para situações simples e de 0,7 situações complexas.



## Iluminancias medias

Average illuminance  
Éclairage moyen  
Iluminância média

Iluminancias medias mantenidas según norma UNE EN-12464 "Iluminación de los lugares de trabajo".

Average illuminance maintaining according to UNE EN-12464 "Lighting of workplaces".

Éclairage moyen maintenu selon UNE EN-12464 "éclairage des lieux de travail".

Iluminância média mantida de acordo com a UNE EN-12464 "A iluminação dos locais de trabalho".

### ACTIVIDAD/ACTIVITY/ACTIVITÉ/ATIVIDADE

OFICINAS/OFFICES/OFFICES/ESCRITÓRIOS	Em (lx)	Ra min.
Fotocopiadoras/Photocopiers/Photocopieurs/Fotocopiadoras	300	80
Archivos/Files/Archives/Registros	200	80
Escritura y tratamiento de datos/Writing and data processing/L'écriture et le traitement des données/Escrita e processamento de dados	500	80
Dibujo técnico/Technical drawing/Dessin technique/Desenho Técnico	750	80
Salas de reuniones/Meeting Rooms/Salles de réunion/Salas de Reunião	500	80
Recepción/Reception/Réception/Recepção	300	80
EDIFICIOS DOCENTES/EDUCATIONAL BUILDINGS/BÂTIMENTS SCOLAIRES/EDIFÍCIOS EDUCACIONAIS	Em (lx)	Ra min.
Salas de lectura/Reading rooms/Salles de lecture/Salas de leitura	500	80
Salas de profesores/Teachers rooms/Salles des professeurs/ Salas dos professores	300	80
Almacenes material escolar/School supplies storage/Entrepôts de matériel scolaire/Armazéns de material escolar	100	80
Gimnasios, piscinas (uso general)/Gyms, swimming pools (general use)/Gymnases, piscines (à usage général)/Ginásios, piscinas (uso geral)	300	80
Comedor/Dining Room/ Salle à Manger/ Sala de Jantar	200	80
Cocina/Kitchen/Cuisine/Cozinha	500	80
Salas de juegos en colegios de educación infantil y guarderías/Playrooms in kindergarten and childcare schools/Les salles de jeux dans les écoles de la maternelle et de garde d'enfants/Salas de jogos em escolas de educação infantil e de creche	300	80
Aulas de arte/Art classrooms/Art classes/Aulas de arte	500	80
Aulas en institutos/Classrooms in high schools/Classe dans les lycées/Aula nas escolas secundárias	300	80
Aulas en colegios nocturnos y para adultos educación artística/Classrooms in night and adult art education schools/Les salles de classe dans les écoles de nuit et l'éducation artistique des adultes/As salas de aula nas escolas noturnas e arte-educação de adultos	500	80
Aulas para dibujo técnico/Classrooms for technical drawing/Classe pour le dessin technique/Aula para desenho técnico	750	80
Aulas de música/Music rooms/Salles de musique/Salas de música	300	80
Aulas de informática/Computer rooms/Les salles informatiques/Salas de informática	300	80
Pizarra (iluminación vertical)/Blackboard (vertical lighting)/Blackboard (éclairage vertical)/Blackboard (iluminação vertical)	500	80
BIBLIOTECAS/LIBRARIES/BIBLIOTHÈQUES/BIBLIOTECAS	Em (lx)	Ra min.
Áreas de lectura/Reading areas/Des espaces de lecture/Áreas de leitura	500	80
Estanterías (iluminación vertical)/Shelves (vertical lighting)/Étagères (éclairage vertical)/Prateleiras (iluminação vertical)	200	80
Puestos de servicio al público/Public service positions/Postes de la fonction publique/Posições de serviço público	500	80
RESTAURANTES/RESTAURANTS/RESTAURANTS/RESTAURANTES	Em (lx)	Ra min.
Iluminación general/General lighting/L'éclairage général/Iluminação geral	200	80
Guardarropa/Cloakroom/Garde-robe/Guarda-roupa	200	80
Cocina/Kitchen/Cuisine/Cozinha	500	80
Restaurantes autoservicio/Self service restaurants/Auto Restaurants/Auto Restaurantes	200	80
Pasillos/Corridors/Couloirs/Corredores	100	80
Caja/Cashbox/Caisse/Cashbox	300	80
ZONAS DE CIRCULACIÓN Y ÁREAS GENERALES INTERIORES/AREAS OF MOVEMENT AND INDOOR GENERAL AREAS/ZONES DE DEPLACEMENT ET DOMAINES GÉNÉRALES À L'INTÉRIEUR/ÁREAS DE MOVIMENTO E ÁREAS INTERIOR GERAIS	Em (lx)	Ra min.
Pasillos (iluminación a nivel de suelo)/Corridors (lighting at ground level)/Couloirs (éclairage au niveau du sol)/Corredores (iluminação ao nível do solo)	100	40
Escaleras, ascensores, escaleras mecánicas/Stairs, elevators, escalators/Escaliers, ascenseurs, escaliers mécaniques/Escadas, elevadores, escadas rolantes	100	40
Salas de descanso/Rest areas/Aires de repos/Áreas de descanso	100	80
Salas de control interruptores/Switches control rooms/Salles de contrôle commutateurs/Salas de controle interruptores	200	60
Baños/Toilets/Toilettes/Banheiros	200	80
Enfermería/Nursing/Soins/Enfermagem	500	80
AMBIENTES INDUSTRIALES Y ARTESANALES/INDUSTRIAL AND HANDICRAFT ENVIRONNEMENTS/ENVIRONNEMENTS INDUSTRIELS ET ARTISANAL/AMBIENTES INDUSTRIAIS E ARTESANATO	Em (lx)	Ra min.
AGRICULTURA/AGRICULTURE/AGRICULTURE/AGRICULTURA		
Sala veterinaria/Veterinary room/Salle vétérinaire/Sala veterinária	200	80
Edificios para ganadería/Livestock buildings/Bâtiments d'élevage/Edifícios para gado	50	-
FABRICACIÓN DE VEHÍCULOS/VEHICLE MANUFACTURING/LA FABRICATION DE VÉHICULES/FABRICAÇÃO DE VEÍCULOS		
Carrocería y ensamblado/Bodywork and assembly/Carrosserie et montage/Carroçaria e montagem	500	80
Cámara de pintado, pulido/Chamber of painting, polished/Chambre peinte, poli/Câmara de pintado, polido	750	80
Pintura: retoque inspección/Painting: retouching inspection/Peinture: l'inspection de retouche/Pintura: inspeção retoque	1.000	90
Fabricación revestimientos interiores inspección final/Production of inner linings final inspection/Faire les revêtements inspection finale/Fazendo forros inspeção final	1.000	80

**ACTIVIDAD/ACTIVITY/ACTIVITÉ/ATIVIDADE**

<b>TRATAMIENTO DE METALES/METAL PROCESSING/TRAITEMENT DES MÉTAUX/PROCESSAMENTO DE METAL</b>		
Trabajos bastos y medios/Hard and medium tasks/Métiers durs et moyennes/Tarefas duros e médios	300	60
Trabajos finos/Easy tasks/Métiers faciles/Tarefas fáceis	500	60
Trazado inspección/Layout inspection/Tracé de l'inspection/Inspeção traçando	750	60
Producción de útiles y herramientas de corte Production of useful and cutting tools Production d'utilité et d'outils de coupe/Produção de úteis e ferramentas de corte	750	60
Soldadura/Welding/Soudage/Soldagem	300	60
Estampación en caliente/Hot stamping/Estampage à chaud/Hot stamping	300	60
Galvanización/Galvanization/Galvanisation/Galvanização	300	80
Ensamblado de precisión/Precision assembly/Assemblée de précision/Assembleia precision	750	80
<b>CENTRALES ELÉCTRICAS/POWER STATIONS/CENTRALES ÉLECTRIQUES/CENTRAIS ELÉTRICAS</b>		
Suministro de combustible/Fuel supply/Alimentation de carburant/Abastecimento de combustível	50	20
Local calderas/Boiler locals/Locales chaudières/Locais caldeiras	100	40
Sala máquinas/Engine rooms/Salle des machines/Sala de máquinas	200	80
Locales bombas, condensadores, cuadros de mandos/Pump locals, condensers, scorecards/Locales pompes, des condenseurs, des tableaux de bord/Locais bombas, condensadores, scorecards	200	60
Salas de control/Control rooms/Salles de contrôle/Salas de controle	500	80
Aparatos de conmutación exterior/External switching devices/Dispositifs de commutation externes/Dispositivos externos de comutação	20	
<b>PRODUCCIÓN TEXTIL/TEXTILE PRODUCTION/PRODUCTION TEXTILE/PRODUÇÃO TÊXTIL</b>		
Área de trabajo al lado de cubas de lavado/Workspace beside washing tanks/Espace de travail à côté des cuves de lavage/Espaço de trabalho ao lado de tanques de lavar roupa	200	60
Peinado, dimensionado/Combing, dimensioning/Peignage, dimensionnement/Estilo de cabelo, dimensionamento	300	80
Hilado, bobinado, plegado/Spinning, winding, folding/Filature, bobinage, pliage/Girar, sinuosa, dobrável	500	80
Tejido, trenzado/Weaving, braiding/Tissage, tressage/Tecer, trança	500	80
Diseño manual, patrones/Manual design, patterns/Design manual, modèles/Projeto manual, padrões	750	90
Inspecciones colores/Color inspections/Inspections des couleurs/Inspeções cores	1.000	90
<b>TRATAMIENTO DE MADERA/WOODWORKING/TRAVAIL DU BOIS/CARPINTARIA</b>		
Procesos automáticos: secado, fabricación de tableros/Automatic processes: drying, board manufacturing/Processus automatiques: séchage, fabrication de panneaux/Processos automáticos: secagem, fabricação de placas	50	40
Tratamiento con vapor/ Steam treatment/Traitement de vapeur/Tratamento de vapor	150	40
Sierra/Saw/Scie/Serra	300	60
Montaje, encolado/Assembly, gluing/Assemblée, collage/Assembleia, colando	300	80
Pintado/Painted/Peint/Pintado	750	80
Trabajos en máquinas/Work with machines/Travail avec machines/Trabalho com máquinas	500	80
Selección de madera/Wood selection/Sélection bois/Madeira seleção	750	90
Control calidad inspección/Quality control inspection/Contrôle de la qualité inspection/Controle de qualidade inspeção	1.000	90
<b>PRODUCTOS ALIMENTICIOS/FOODSTUFF/PRODUITS ALIMENTAIRES/PRODUTOS ALIMENTARES</b>		
Puestos de trabajo/Workstations/Postes de travail/Postos de trabalho	200	80
Lavado de productos y clasificación/Washing products and classification/Produits de lavage et classification/Produtos de lavagem e classificação	300	80
Puestos de trabajo en carnicerías y mataderos/Workstations in butchers and slaughterhouse/Postes dans les boucheries et abattoirs/Postos em açouques e matadouros	500	80
Puros y cigarrillos/Cigars and cigarettes/Cigares et cigarettes/Charutos e cigarros	500	80
Fabricación delicatessen/Production of delicatessen/Production de épicerie fine/Produção de delicatessen	500	80
Inspecciones de los colores/Color inspections/Inspections des couleurs/Inspeções cores	1.000	90
<b>ALMACENES/STORES/MAGASINS/ARMAZÉNS</b>		
Estación de control/Control station/Station de contrôle/Estação de Controle	150	60
Áreas de almacenaje/Storage areas/Zones de stockage/Áreas de armazenamento	100	60
Áreas de almacenaje ocupado en continuo/Continuously occupied storage areas/Zones de stockage occupé en permanence/Áreas de armazenamento ocupado continuamente	200	60
Pasillos sin personas (nivel suelo)/Corridors without people (ground level)/ Couloirs sans personnes (niveau du sol)/Corredores sem pessoas (nível do solo)	20	40
Pasillos con personas (nivel suelo)/Corridors with people (ground level)/ Couloirs avec des personnes (niveau du sol)/Corredores com pessoas (nível do solo)	150	60
<b>APARCAMIENTOS CUBIERTOS/COVERED PARKINGS/PARKING COUVERT/ESTACIONAMENTO COBERTO</b>		
Caja/Cashbox/Caisse/Cashbox	300	80
Calles de circulación y áreas de aparcamiento (ilum. a nivel del suelo)/Streets of circulation and parking areas (lighting at ground level)/Rues de zones de circulation et de stationnement (éclairage au niveau du sol)/Ruas de circulação e áreas de estacionamento (iluminação ao nível do solo)	75	20
Rampas de entrada-salida (de día) (iluminación a nivel del suelo)/Entry-exit ramps (day) (lighting at ground level)/Rampes d'entrée-sortie (jour) (éclairage au niveau du sol)/Rampas de entrada e saída (dia) (iluminação ao nível do solo)	300	40
Rampas de entrada-salida (de noche) (iluminación a nivel del suelo)/Entry-exit ramps (night) (lighting at ground level)/Rampes d'entrée-sortie (nuit) (éclairage au niveau du sol)/Rampas de entrada e saída (noite) (iluminação ao nível do solo)	75	40
<b>OTROS LOCALES/ OTHER LOCALS/AUTRES LOCAUX/OUTROS LOCAIS</b>		
Áreas de ventas/Sales areas/Points de vente/Áreas de vendas	300	80
Caja/Cashbox/Caisse/Cashbox	500	80
Exposiciones/Exhibitions/Expositions/Exposições	500	80
Peluquerías/Hairdressers/Coiffeurs/Cabeleireiros	500	90
Gimnasios/Gyms/Gymnases/Ginásios	300	80

## Iluminancias medias

Average illuminance  
Éclairage moyen  
Iluminância média

Iluminancias medias mantenidas según norma UNE EN-12464 "Iluminación de los lugares de trabajo".

En el alumbrado de instalaciones deportivas se diferencian los niveles de competición mediante clases:

CLASE I: Competición internacional y nacional. Entrenamiento de muy alto nivel.

CLASE II: Competición regional o de club local. Entrenamiento de alto nivel.

CLASE III: Competición local sin espectadores. Entrenamiento general, colegios y actividades recreativas.

Average illuminance maintaining according to UNE EN-12193 "Lighting of sports facilities".

The lighting of sports competition levels are differentiated by class:

CLASS I: International and national competition. High level training.

CLASS II: Regional or local club competition. High level training.

CLASS III: Local Competition without spectators. General training, schools and recreational activities.

Éclairage moyen maintenu selon UNE EN-12193 "éclairage d'installations sportives".

L'éclairage des niveaux de compétitions sportives sont différenciés par classe:

CLASSE I: La compétition internationale et nationale. Formation de haut niveau.

CLASSE II: Compétition dans régional ou local club. Formation de haut niveau.

CLASSE III: Compétition local sans spectateurs. Formation générale, les écoles et les activités récréatives.

Iluminância média mantida de acordo com a UNE EN-12193 "A iluminação de instalações desportivas".

A iluminação dos níveis de competição esportiva são diferenciados por classe:

CLASSE I: Competição internacional e nacional. Treinamento de alto nível.

CLASSE II: Competição de clubes regionais ou locais. Treinamento de alto nível.

CLASSE III: Competição local sem espectadores. A formação geral, as escolas e atividades recreativas.

ACTIVIDAD/ACTIVITY/ACTIVITÉ/ATIVIDADE	Em			Uniformidad Uniformity Uniformité Uniformidade		
	III	II	I	III	II	I
INSTALACIONES DEPORTIVAS DE INTERIOR INDOOR SPORTS FACILITIES INSTALLATIONS SPORTIVES INTÉRIEURES INSTALAÇÕES DESPORTIVAS FECHADAS						
Aerobic/Aerobic/Aérobic/Aeróbica	200	300	500	0,5	0,7	0,7
Baloncesto/Basketball/Basket-ball/Basquete	200	500	750	0,5	0,7	0,7
Balonmano/Handball/Handball/Handebol	200	500	750	0,5	0,7	0,7
Fútbol sala/Indoor soccer/Futsal/Futsal	200	500	750	0,5	0,7	0,7
Kárate/Karate/Karaté/Karatê	200	500	750	0,5	0,7	0,7
Judo/Judo/Judo/Judo	200	500	750	0,5	0,7	0,7
Levantamiento de peso/Weightlifting/Haltérophilie/Levantamento de peso	200	500	750	0,5	0,7	0,7
Voleibol/Volleyball/Volley-ball/Voleibol	200	500	750	0,5	0,7	0,7
Tenis/Tennis/Tennis/Tênis	300	500	750	0,5	0,7	0,7
Natación/Swimming/Natation/Natação	200	300	500	0,5	0,7	0,7
Pádel/Paddle/Paddle/Paddle	300	500	750	0,5	0,7	0,7
INSTALACIONES DEPORTIVAS DE EXTERIOR OUTDOOR SPORTS FACILITIES INSTALLATIONS SPORTIVES EXTÉRIEURES INSTALAÇÕES DESPORTIVAS AO AR LIVRE						
Baloncesto/Basketball/Basket-ball/Basquete	75	200	500	0,5	0,6	0,7
Balonmano/Handball/Handball/Handebol	75	200	500	0,5	0,6	0,7
Fútbol sala, 7, 11 y americano/Indoor soccer, 7, 11 and football/Futsal/Futsal	75	200	500	0,5	0,6	0,7
Voleibol/Volleyball/Volley-ball/Voleibol	75	200	500	0,5	0,6	0,7
Tenis/Tennis/Tennis/Tênis	200	300	500	0,6	0,7	0,7
Natación/Swimming/Natation/Natação	200	300	500	0,5	0,7	0,7
Pádel/Paddle/Paddle/Paddle	200	300	500	0,5	0,7	0,7

TIPO DE VIAS Y USO	CLASE / CRITERIOS	LUMINANCIA cd/m <sup>2</sup>		ILUMINANCIA lux				
		MEDIA Uo		CLASE	MEDIA Um			
A1	AUTOPISTAS Y AUTOVÍAS.	ME1	IMD ≥ 25.000 (3 intersecciones/km)	2	≥ 0.4	CE1	30	≥ 0.4
		ME2	IMD > 25.000 (< 3 Intersecciones/km)	1.5	≥ 0.4	CE2	20	≥ 0.4
		ME2	15,000 ≤ IMD < 25.000 (≥ 3 intersecciones/km)	1.5	≥ 0.4	CE2	20	≥ 0.4
		ME3a	IMD < 25.000 (< 3 intersecciones/km)	1	≥ 0.4	CE3	15	≥ 0.4
		ME3a	IMD < 15.000	1	≥ 0.4	CE3	15	≥ 0.4
A1	CARRETERAS UNICA CALZADA, DOBLE SENTIDO, VÍAS RÁPIDAS.	ME1	IMD > 15.000	2	≥ 0.4	CE1	30	≥ 0.4
		ME2	15,000 < IMD < 25.000 (< 3 intersecciones/km)	1.5	≥ 0.4	CE2	20	≥ 0.4
		ME2	IMD < 15.000 (≥ 3 intersecciones/km)	1.5	≥ 0.4	CE2	20	≥ 0.4
		ME3a	IMD < 15.000 (< 3 intersecciones/km)	1	≥ 0.4	CE3	15	≥ 0.4
A2	CARRETERAS SIN ACERAS, CARRETERAS RURALES.	ME2	IMD ≥ 7.000 (≥ 3 intersecciones/km)	1.5	≥ 0.4	CE2	20	≥ 0.4
		ME3a	IMD > 7.000 (< 3 intersecciones/km)	1	≥ 0.4	CE3	15	≥ 0.4
		ME3a	IMD < 7.000 (≥ 3 intersecciones/km)	1	≥ 0.4	CE3	15	≥ 0.4
		ME4a	IMD < 7.000 poco transito	0.75	≥ 0.4	CE4	10	≥ 0.4
A3	CARRETERAS RÁPIDAS EN CIUDADES, CIRCUNVALACIONES, RONDAS.	ME1	IMD ≥ 25.000 (≥ 3 intersecciones/km)	2	≥ 0.4	CE1	30	≥ 0.4
		ME2	IMD > 25.000 (< 3 intersecciones/km)	1.5	≥ 0.4	CE2	20	≥ 0.4
		ME2	IMD ≥ 15.000 y < 25.000	1.5	≥ 0.4	CE2	20	≥ 0.4
		ME3b	IMD ≥ 7.000 y < 15.000	1	≥ 0.4	CE3	15	≥ 0.4
		ME4a/ME4b	IMD < 7.000	0.75	≥ 0.4	CE4	10	≥ 0.4
-	GLORIETAS Y FONDOS DE SACO (ITC-EA-02-3.7).	Una clase superior del tramo de mayor clase que confluye en la zona						
B1	CALLES PRINCIPALES EN CIUDADES / ARTERIAS URBANAS.	ME2	IMD ≥ 7.000 comercial/turístico	1.5	≥ 0.4	CE2	20	≥ 0.4
		ME3c	IMD ≥ 7.000	1	≥ 0.4	CE3	15	≥ 0.4
		ME4b	IMD < 7.000	0.75	≥ 0.4	CE4	10	≥ 0.4
B2	CAMINOS/CARRETERAS RURALES.	ME3c	IMD ≥ 7.000	1	≥ 0.4	CE3	15	≥ 0.4
		ME4b	IMD < 7.000	0.75	≥ 0.4	CE4	10	≥ 0.4
		ME5	IMD < 7.000	0.5	≥ 0.35	CE5	7.5	≥ 0.4
D1/D2	AREAS DE APARCAMIENTOS, ESTACIONES DE AUTOBUSES.	Alto flujo, comercial, turístico, ocio		-	-	CE2	20	≥ 0.4
		Normal		-	-	CE3	15	≥ 0.4
		Bajo flujo peatonal		-	-	CE4	10	≥ 0.4
D3/D4	CALLES RESIDENCIALES CON VEHÍCULOS Y CON ACERAS A LO LARGO DE LA CALZADA.	Muy alto flujo: comercial, turístico, ocio		-	-	CE2	20	≥ 0.4
		Alto flujo peatonal: comercial, ocio		-	-	S1	15	≥ 0.2
		Alto/medio flujo peatonal: zona algo comercial		-	-	S2	10	≥ 0.2
		Normal		-	-	S3	7.5	≥ 0.2
		Bajo flujo peatonal		-	-	S4	5	≥ 0.2
E1/E2	PLAZAS URBANAS Y ZONAS PEATONALES.	Alto flujo peatonal, comercial y turístico		-	-	CE2	20	≥ 0.4
		Alto flujo peatonal (comercial-ocio)		-	-	S1	15	≥ 0.2
		Normal urbano		-	-	S2	10	≥ 0.2
		Bajo flujo peatonal		-	-	S3	7.5	≥ 0.2
		Muy Bajo flujo peatonal		-	-	S4	5	≥ 0.2
-	PASARELAS PEATONALES, ESCALERAS, RAMPAS, PASOS DE PEATONES.	Zona Residencial (ITC-EA-02-3.1/3.3)		-	-	CE2	20	≥ 0.4
		Zona Comercial (ITC-EA-02-3.1/3.3)		-	-	CE1	30	≥ 0.4
-	VIGILANCIA/SEGURIDAD: INDUSTRIAS, COMERCIOS, INSTALACIONES DEPORTIVAS, ETC (SEGÚN PELIGROSIDAD).(ITC-EA-02-5)	Alto Riesgo		-	-	-	50	≥ 0.3
		Riesgo Elevado		-	-	-	20	≥ 0.3
		Riesgo normal		-	-	-	5	≥ 0.3
-	PORTALES Y ACCESOS A EDIFICIOS (RD 314/2006 SUA 4.1)	Portal, pasillos abiertos, acceso principal zona segura		-	-	-	20	≥ 0.4
		Resto zona aparcamiento D1/D2: CE4		-	-	-	10	≥ 0.4
		Resto de zonas peatonales E1/E2: S2-S4		-	-	-		≥ 0.4

**NOTAS** Los valores de iluminancia/luminancia media son de referencia. No deben superar más del 20%. Esto es una tabla resumen, para ampliar información y trabajar con datos más precisos pueden leer el RD 1890/2008 y su guía técnica de aplicación.



## Carta RAL

RAL chart  
Tableau RAL  
Gráfico RAL

La carta RAL es un modelo de color estandarizado. Sirve de referencia, a nivel internacional, para conocer de forma exacta el acabado final del producto.

A continuación se muestran los colores utilizados en los productos Prilux.

The RAL chart is an standardized colour model. Serving as worldwide reference to know exactly the final finish of the product.

Below are given the range of colours which are using in all the products of Prilux.

Le tableau RAL est un modèle de couleur normalisé. Servant de référence dans le monde entier pour savoir exactement la finition du produit.

Ci-dessous sont donnés la gamme de couleurs qui utilisent dans tous les produits de Prilux.

O gráfico RAL é um modelo de cor padronizada. Servindo como referência mundial para saber exatamente o acabamento final do produto.

Abaixo é dada a gama de cores que estão usando em todos os produtos da Prilux.

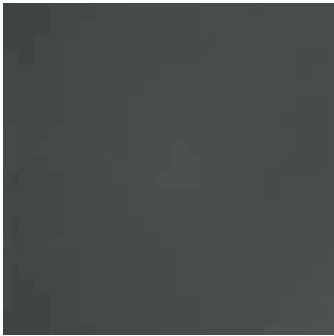

RAL 7010

Gris lona  
Tarpaulin grey  
Gris tente  
Cizento lienzo

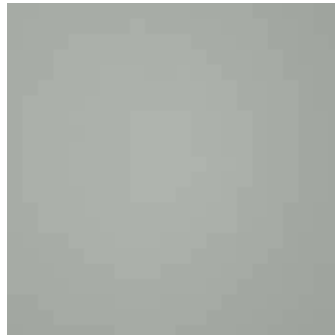

RAL 7038

Gris ágata  
Agate grey  
Gris agate  
Cinza ágata

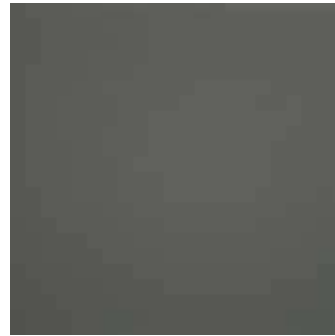

RAL 7039

Gris cuarzo  
Quartz grey  
Gris quartz  
Cizento quartzo



RAL 9004

Negro señales  
Signal black  
Noir de sécurité  
Preto sinal

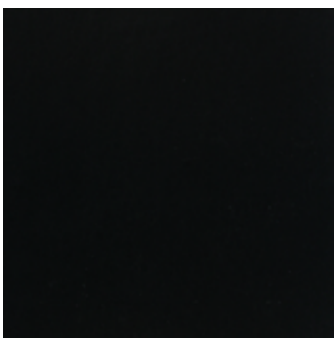

RAL 9005

Negro intenso  
Jet black  
Noir foncé  
Cor do azeviche



RAL 9006

Aluminio blanco  
White aluminium  
Aluminium blanc  
Branco alumínio



RAL 9007

Aluminio gris  
Grey aluminium  
Aluminium gris  
Cizento alumínio

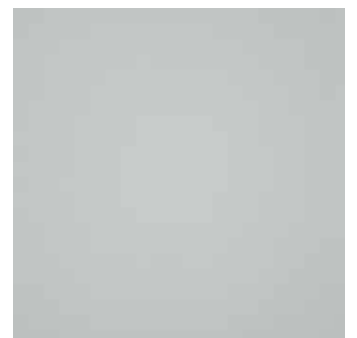

RAL 9018

Blanco papiro  
Papyrus white  
Blanc papyrus  
Branco papiro

\* Debido a causas técnicas de la impresión y del papel utilizado para realizar este catálogo pueden aparecer variaciones con respecto a los colores y texturas originales, pudiendo no ser del todo fiel a la realidad.

\* Due to technical causes from the printer and the using paper to present catalogue, it might be some variations in relation to the original colours and textures, therefore, it can be less accurate.

\* Due à des causes techniques de l'imprimante et l'utilisation de papier à présenter catalogue, il pourrait y avoir quelques variations par rapport aux couleurs et textures originales, par conséquent, il peut être moins précis.

\* Devido a causas técnicas da impressora e do papel utilizado a apresentar catálogo, pode haver algumas variações em relação às cores originais e texturas, portanto, pode ser menos precisas.

## Certificaciones

Certifications  
Certifications  
Certificações



SGS ISO 9001



SGS ISO 14001



SGS ISO 45001



SGS ISO 50001

## Condiciones de Uso

Terms of use  
Condition d'utilisation  
Condições de uso

## Condiciones de Garantía

Warranty Conditions  
Conditions de garantie  
Condições de garantia













## Condiciones de Venta

















Terms of sale  
Conditions de vente  
Condições de venda







	ESPAÑOL (Ñ)	ENGLISH (E)	FRANÇAIS (F)	PORTUGUÊS (P)
	Código	Code	Code	Código
<b>W</b>	Potencia (W)	Power (W)	Puissance (W)	Potência (W)
<b>W<sub>LED</sub></b>	Potencia LED (W)	LED Power (W)	Puissance LED (W)	Potência LED (W)
<b>W<sub>T</sub></b>	Potencia Total (W)	Total Power (W)	Puissance Total (W)	Potência Total (W)
	Modelo	Model	Modèle	Modelo
	Tensión (V)	Voltage (V)	Tension D` Alimentation (V)	Tensão (V)
	Tensión Entrada (V)	Input Voltage (V)	Tension D` Alimentation D` Entrée (V)	Tensão de entrada (V)
	Tensión Salida (V)	Output Voltage (V)	Tension D` Alimentation D` Sortie (V)	Tensão de saída (V)
<b>Hz</b>	Frecuencia (Hz)	Frequency (Hz)	Fréquence (Hz)	Frequência (Hz)
	Intensidad (A)	Current (A)	Intensité (A)	Intensidade (A)
	Intensidad (A)	Output Current (A)	Intensité D` Entrée (A)	Intensidade de saída (A)
<b>φ</b>	Factor de potencia (Cosφ)	Power factor (Cosφ)	Facteur de puissance (Cosφ)	Fator de Potência (Cosφ)
	Clase I Aislamiento eléctrico	Class I Electrical isolation	Classe I Isolation électrique	Clase I Isolamento elétrico
	Clase II Aislamiento eléctrico	Class II Electrical isolation	Classe II Isolation électrique	Clase II Isolamento elétrico
	Clase III Aislamiento eléctrico	Class III Electrical isolation	Classe III Isolation électrique	Clase III Isolamento elétrico
	IP Índice de estanqueidad	IP Sealing rating	IP Indice d` étanchéité	IP Índice de selagem
	IP Luminaria Índice de estanqueidad	IP Luminaire Sealing rating	IP Luminaire Indice d` étanchéité	IP luminaria Índice de selagem
	IP instalado Índice de estanqueidad	IP installed Sealing rating	IP installé Indice d` étanchéité	IP instalado Índice de selagem
	IP grupo óptico Índice de estanqueidad	IP optical group Sealing rating	IP groupe optique Indice d` étanchéité	IP grupo ótico Índice de selagem
	IP Cuerpo	IP Body	IP Corps	IP Corpo
	IP Driver	IP Driver	IP Driver	IP Driver
	IK Protección contra impactos	IK Impact resistance	IK Protection contre des impacts	IK Proteção contra impactos
	IK Luminaria	IK Luminaire	IK Luminaire	IK Luminária
	IK grupo óptico Protección contra impactos	IK optical group Impact resistance	IK groupe optique Protection contre des impacts	IK grupo ótico Proteção contra impactos
	TLCI	TLCI	TLCI	TLCI

	ESPAÑOL (Ñ)	ENGLISH (E)	FRANÇAIS (F)	PORTUGUÊS (P)
	Rf. Skin	Rf. Skin	Rf. Skin	Rf. Skin
	Temperatura de funcionamiento	Operating temperature	Température de service	Temperatura de trabalho
$\phi$	Flujo Luminoso (lm)	Flux (lm)	Flux (lm)	Fluxo (lm)
$\phi_{LED}$	Flujo LED (lm)	LED Flux (lm)	Flux LED (lm)	Fluxo LED (lm)
$\phi_T$	Flujo Total (lm)	Total Flux (lm)	Flux Total (lm)	Fluxo Total (lm)
$\phi/w$	Eficacia (lm/w)	Eficacia (lm/w)	Eficacia (lm/w)	Eficacia (lm/w)
$\eta$	Rendimiento	Rendimento	Rendimento	Rendimento
	Ángulo de apertura	Opening angle	Angle d'ouverture	Ângulo de abertura
	Óptica	Optical	Optique	Óptica
<b>K</b>	Temperatura de color	Colour temperature	Température de couleur	Temperatura de cor
	Flujo Hemisférico Superior	Higher Hemispheric Flow	Débit hémisphérique supérieur	Fluxo Hemisférico Superior
	CRI Índice de reproducción cromática	CRI Colour rendering index	CRI Indice de rendu des couleurs	CRI Índice de reprodução cromática
	UGR	UGR	UGR	UGR
	Número de led	LED number	Nombre de led	Número de led
	Iluminación directa/indirecta	Direct/indirect lighting	Éclairage direct / indirect	Iluminação direta / indireta
	Vida útil	Lifetime	Heures de vie	Vida
	Color	Colour	Couleur	Cor
	Peso	Weight	Poids	Peso
	Carga estática	Static load	Static charge	Carga estática
	Dimensiones	Measures	Dimensions	Dimensão
	Resistencia al Viento	Wind Resistance	Résistance au vent	Resistência ao vento
	Cuerpo	Body	Corps	Corpo
	Difusor	Diffuser	Diffuseur	Difusor
	Cubre módulos	Covers modules	Couvre les modules	Abrange módulos
	Marco	Frame	Cadre	Quadro

	ESPAÑOL (Ñ)	ENGLISH (E)	FRANÇAIS (F)	PORTUGUÊS (P)
	Reflector	Reflector	Réflecteur	Refletor
	Diámetro de Poste	Pole Diameter	Diamètre du Poteau	Diâmetro do Pólo
	Montaje	Mounting	L'assemblée	Assembly
	Corte	Cutting	Coupe	Corte
	Instalación remota	Remote installation	Installation à distance	Instalação remota
	Luminaria de empotrar	Recessed luminaire	Luminaire encastré	Luminária de encastrar
	Luminaria de superficie	Surface luminaire	Luminaire de surface	Luminária de superfície
	Luminaria de suspender	Suspension luminaire	Suspension luminaire	Luminária de suspensão
	Giro de la luminaria	Turn of the luminaire	Tour du luminaire	Orientação da luminária
	Regulable	Dimmable	Dimmable	Regulável
	Protocolo Comunicación para reprogramación	Communication Protocol for reprogramming	Protocole de communication pour reprogrammation	Protocolo de comunicação para reprogramação
	Configuración	Configuration	Configuration	Configuração
	Sensor	Sensor	Capteur	Sensor
	Protección sobretensión	Overvoltage protection	Protection contre les surtensions	Proteção contra sobretensão
	Protección térmica	Thermal protection	Protection thermique	Proteção térmica
	Protección Sobretensiones	Surges protection	Protection surfaces	Proteção surtos
	Alimentación	Power supply	Source de courant	Fonte de energia
	Accesorios	Accessories	Accessoires	Acessórios
	Bajo pedido	On request	Sur commande	A pedido
	Información	Information	Information	Informações
	Aviso	Notice	Avis	Aviso

	ESPAÑOL (Ñ)	ENGLISH (E)	FRANÇAIS (F)	PORTUGUÊS (P)
VA	Asimetrías de uso vial	Road use asymmetric	Asymétrique d'utilisation de la route	Assimétrica na utilização da estrada
PPD / PPI	Ópticas para pasos de peatones	Optics for pedestrian crossings	Optique pour les passages piétons	Óptica para passagens de peões
S	Simétricas	Symmetric	Symétrique	Simétrica
PIN / PEX	Ópticas tipo pasillo	Aisle-type optics	Optique de type allée	Óptica do tipo corredor
AIN / AEX	Ópticas asimétricas estándar	Standard asymmetric optics	Optique asymétrique standard	Óptica assimétrica padrão

## Regulación

Dimming  
Dimmable  
Regulável

	ESPAÑOL (Ñ)	ENGLISH (E)	FRANÇAIS (F)	PORTUGUÊS (P)
1-10V	Regulación 1-10V	Dimmable 1-10V	Dimmable 1-10V	Dimerizável 1-10V
DN	Doble nivel preprogramado	Double preprogrammed level	Double niveau préprogrammé	Duplo nível pré-programado
DN/LM	DN con línea de mando	Double level with command line	Double niveau avec ligne de commande	Duplo nível com linha de comando
5N	5 Niveles	5 Levels	5 Niveaux	5 Níveis
DALI	Dali	Dali	Dali	Dali
DMX	Regulación DMX	DMX Dimming	Atténuation DMX	Regulação DMX
DINÁMICO	Regulación Dinámica	Dinamic Dimming	Atténuation Dynamique	Regulação Dinâmica



Regulación DALI  
DALI Dimming  
Atténuation DALI  
Regulação DALI



Regulación 1-10V  
1-10V Dimming  
Atténuation 1-10V  
Regulação 1-10V



Regulación DMX  
DMX Dimming  
Atténuation DMX  
Regulação DMX



Regulación Dinámica  
Dynamic Dimming  
Atténuation Dynamique  
Regulação Dinâmica



**Cuerpo**  
Body  
Corps  
Corpo

	ESPAÑOL (Ñ)	ENGLISH (E)	FRANÇAIS (F)	PORTUGUÊS (P)
AL	Aluminio	Aluminum	Aluminium	Alumínio
FE	Acero	Steel	Acier	Aço
PVC	PVC	PVC	PVC	PVC
ABS	Plástico ABS	Plastic ABS	Plastique ABS	Plástico ABS
AL	Aluminio	Aluminium	Aluminium	Alumínio

**Difusor**  
Diffuser  
Diffuseur  
Difusor

	ESPAÑOL (Ñ)	ENGLISH (E)	FRANÇAIS (F)	PORTUGUÊS (P)
VT-T	Vidrio Templado transparente	Transparent Tempered glass	Verre trempé transparent	Vidro temperado transparente
PMMA-T	Polimetilmetacrilato transparente	Transparent Polymethylmethacrylate	Polyméthacrylate de méthyle transparent	Polimetilmetacrilato transparente
PMMA-P	PMMA prismático	Prismatic polymethylmethacrylate	Polyméthacrylate de méthyle prismatique	Polimetilmetacrilato prismático
PC-T	Polycarbonato transparente	Transparent Polycarbonate	Polycarbonate transparent	Polycarbonato transparente
PC-O	Polycarbonato opal	Opal polycarbonate	Polycarbonate opale	Polycarbonato opal
PC-P	Polycarbonato prismático	Prismatic Polycarbonate	Polycarbonate prismatique	Polycarbonato prismático
PS	Poliestireno	Polystyrene	Polystyrène	Poliestireno
AL-AN	Aluminio Anodizado	Anodized aluminum	Aluminium anodisé	Alumínio anodizado
AL-SP	Aluminio Especular	Specular Aluminium	Aluminium spéculaire	Alumínio especular

---

## GRUPO PRILUX ILUMINACIÓN S.L.U.

---

### SEDE CENTRAL

---

C/ Río Jarama nº 149.45007, Toledo (Spain).  
Tel.: 925 23 38 12 / Fax: 925 23 38 80

---

### DELEGACIÓN NORESTE

---

Carretera BV - 2249 Km 8  
08791, Sant Llorenç d'Hortons, Barcelona (Spain).

**Prilux eConcept** Tel.: (+34) 93 891 37 24

**Grupo Prilux Iluminación S.L.U** Tel: (+34) 93 719 23 29

---

[www.grupoprilux.com](http://www.grupoprilux.com)

---

---

### IMPRESIÓN

---

Abril 2022

---

---

### DISEÑO GRÁFICO

---

Departamento de Marketing

---

Pueden aparecer variaciones con respecto al color original debido a causas técnicas de la impresión.

Este catálogo actualiza los valores y características de las mismas luminarias que aparezcan en anteriores catálogos.

Los datos incluidos en este catálogo son correctos salvo error tipográfico.

Grupo Prilux Iluminación S.L.U. se reserva el derecho a cualquier modificación del producto sin previo aviso.

---

Web





prilux.es

